

CONTENT

A-Z

OWNER'S MANUAL. MINI COUNTRYMAN.

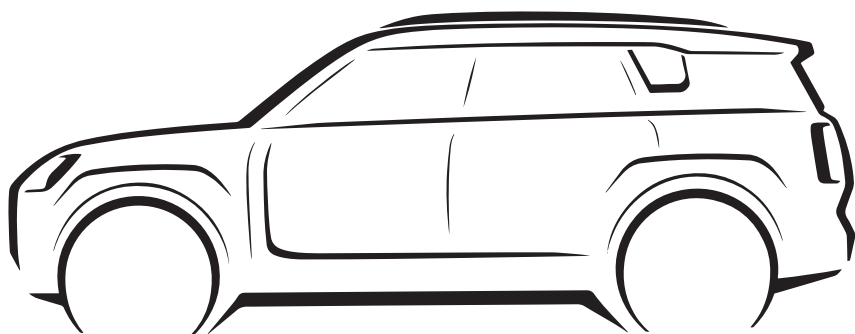



WELCOME TO MINI.

OWNER'S MANUAL.

Thank you for choosing a MINI.

The more familiar you are with the vehicle, the better control you will have on the road. We therefore strongly suggest the following:

Read this Owner's Manual before starting off in your new MINI. Also use the Integrated Owner's Manual in the vehicle. It contains important notes on vehicle operation that will help you make full use of the technical features available in your MINI. The manual also contains information designed to enhance operating reliability and traffic safety, and to contribute to maintaining the value of your MINI.

At the time of production at the plant, the printed Owner's Manual is the most current resource. The Integrated Owner's Manual for the vehicle will contain the latest information after the vehicle software is updated, e.g., after a MINI Remote Software Upgrade.

Get started now. We wish you driving fun and inspiration with your MINI.

TABLE OF CONTENTS

The Integrated Owner's Manual for the vehicle will contain the latest information after the vehicle software is updated, e.g., after a MINI Remote Software Upgrade.

! NOTES

Information.....	6
Electric drive.....	16
Safety of the high-voltage system.....	19

🔗 QUICK REFERENCE

Getting in.....	22
Set-up and use.....	25
On the road.....	28

👇 CONTROLS

Dashboard.....	36
Sensors of the vehicle.....	40
Operating state of the vehicle.....	45
Display and operating concept.....	49
MINI Remote Software Upgrade.....	61
Personal settings.....	66
Opening and closing.....	74
Seats, mirrors and steering wheel.....	104
Transporting children safely.....	120
Driving.....	127
Displays.....	142
Light and view.....	160
Safety.....	174
Driving stability control systems.....	216
Driver assistance systems.....	221
Parking.....	249

Driving comfort.....	282
Climate control.....	283
Interior equipment.....	293
Storage compartments.....	300
Cargo area.....	304

DRIVING TIPS

Things to remember when driving.....	312
Trailer and rear carrier.....	318
Increasing range.....	327

MOBILITY

Charging the vehicle.....	332
Wheels and tires.....	347
Under the hood.....	373
Operating fluids.....	376
Maintenance.....	378
Replacing components.....	380
Breakdown Assistance.....	384
Vehicle care.....	392

REFERENCE

Technical data.....	398
Appendix.....	400
Everything from A to Z.....	402

Information

Using this Owner's Manual

Orientation

The fastest way to find information on a particular topic is by using the index.

For an overview of the vehicle, we recommend reading the Quick Reference Guide in the Owner's Manual.

Validity of the Owner's Manual

Production of the vehicle

At the time of production at the plant, the printed Owner's Manual is the most current resource.

Depending on the national-market version, there may be differences between the vehicle's printed Owner's Manual and the Integrated Owner's Manual due to updates made after going to print.

Notes on updates can be found in the appendix of the printed Owner's Manual for the vehicle.

After a software update in the vehicle

After a vehicle software update, for example, via Remote Software Upgrade, the Integrated Owner's Manual for the vehicle will contain the latest information, depending on the national-market version.

Before setting off, make sure that the Integrated Owner's Manual is available and up-to-date.

Owner's Manual for Navigation, Entertainment, Communication

The Owner's Manual for Navigation, Entertainment, and Communication can be ob-

tained as a printed book from an authorized service center.

The topics are also discussed in the Integrated Owner's Manual in the vehicle.

Media at a glance

General information

The contents of the Owner's Manual are available in various media formats. The following Owner's Manual media formats are available:

- Printed Owner's Manual.
- Integrated Owner's Manual in the vehicle.

Printed Owner's Manual

The printed Owner's Manual shows all standard, country-specific, and optional equipment that is currently available, or may become available in the future, for specific models.

Integrated Owner's Manual in the vehicle

Principle

The Integrated Owner's Manual shows all standard, country-specific, and optional equipment that is currently available, or may become available in the future, for specific models. The Integrated Owner's Manual can be displayed on the Interaction Unit.

Functional requirement

The Integrated Owner's Manual is provided depending on national-market version.

Selecting the Owner's Manual

1. Go through the menu as follows: Apps menu / "All" / "Owner's Manual".
2. Select the desired method for accessing the contents.

Scrolling through the Owner's Manual

Swipe up or down until the next or previous contents are displayed.

Context help

General information

The Integrated Owner's Manual can be accessed from any menu. Depending on the selected function, either the associated description or the main menu of the Integrated Owner's Manual will be displayed.

Selecting context help from a menu

1. Press and hold the desired menu item.
2. "General help"

Selecting context help from a Check Control message

Directly from the Check Control message on the Interaction Unit:

"Owner's Manual"

After a software update in the vehicle

After a vehicle software update, for example, via Remote Software Upgrade, the Integrated Owner's Manual for the vehicle will contain the latest information, depending on the national-market version.

Before setting off, make sure that the Integrated Owner's Manual is available and up-to-date.

Supplementary documentation

Additional documents, e.g., Supplementary Owner's Manuals, brochures, or inserts, supplement the media included with the Owner's Manual. Supplementary Owner's Manuals or brochures contain, for example, information on special models or information that must be communicated in printed form due to legal requirements. Inserts may include different information than that given in the media included with the Owner's Manual. Follow all additional documents that may be enclosed with the on-board literature.

Additional sources of information

Authorized service center

An authorized service center, e.g., a MINI dealer or service center, will be happy to answer any questions.

Internet

Vehicle information and general information on MINI, e.g., on technology, are available on the Internet: www.miniusa.com.

MINI Motorer's Guide app



The app shows all standard, country-specific, and optional equipment that is currently available, or may become available in the future, for specific models. The app can be displayed on smartphones and tablets.

MINI Motorer's Guide Web

The Driver's Guide website shows all standard, country-specific, and optional equipment that is currently available, or may become available in the future, for specific models. Driver's Guide Web can be displayed in any current browser.

Icons and displays

Icons in the Owner's Manual

Icon	Meaning
	Precautions that must be followed in order to avoid the possibility of injury to yourself and to others as well as serious damage to the vehicle.
	Measures that can be taken to help protect the environment.
"..."	Texts in vehicle used to select individual functions.
>...<	Verbal instructions to use with the voice activation system.
>>...<<	Responses generated by the voice activation system.

Action steps

Action steps to be carried out are presented as a numbered list. These steps must be carried out in the order shown.

1. First action step.
2. Second action step.

Bulletpoint lists

Items or actions without strict order or alternative options are shown as a bulletpoint list.

- First possibility.
- Second possibility.

Icons on vehicle parts

 This symbol on a vehicle component indicates that further information on the component is available in the Owner's Manual.

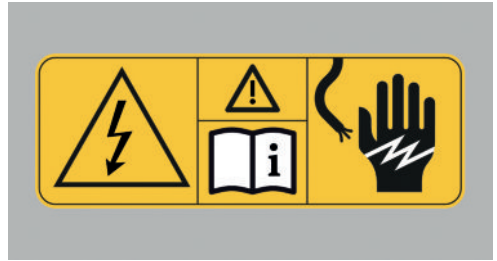

The high-voltage safety icons found on vehicle part indicate that incorrect use of high-voltage technology or of orange-colored high-voltage components poses a risk of life-threatening injury by electric shock.

Vehicle features and options

This Owner's Manual shows all standard, country-specific, and optional equipment that is currently available, or may become available in the future, for specific models, i.e., model series. Therefore, this Owner's Manual also describes and illustrates equipment, systems and functions that are not available in a vehicle, for example due to the following situations:

- Selected optional equipment.
- National-market version or national-market equipment.
- Options for later release and software update.

This also applies to safety functions and systems.

Before starting a journey, verify whether the described equipment or function is available in the vehicle. For information on whether a function is currently available in the vehicle or when the function can be installed in the vehicle, contact an authorized service center or another qualified service center or repair shop.

A claim for the availability of equipment, a system or a function in the vehicle cannot be derived based on the description in the Owner's Manual.

When using these functions and systems, the applicable laws and regulations must be observed.

For any equipment and models not described in this Owner's Manual, refer to any supplementary documentation included, e.g., Supplementary Owner's Manuals, inserts.

An authorized service center is happy to answer any questions that you may have about the features and options applicable to the vehicle.

Status of the Owner's Manual

Basic information

The manufacturer of the vehicle pursues a policy of constant development to ensure that our vehicles continue to embody the highest quality and safety standards. In rare cases, therefore, the features described in this Owner's Manual may deviate from those in the vehicle.

Validity of the Owner's Manual

Production of the vehicle

At the time of production at the plant, the printed Owner's Manual is the most current resource.

Depending on the national-market version, there may be differences between the vehicle's printed Owner's Manual and the Integrated Owner's Manual due to updates made after going to print.

Notes on updates can be found in the appendix of the printed Owner's Manual for the vehicle.

After a software update in the vehicle

After a vehicle software update, for example, via Remote Software Upgrade, the Integrated Owner's Manual for the vehicle will contain the latest information, depending on the national-market version.

Before setting off, make sure that the Integrated Owner's Manual is available and up-to-date.

For Your Own Safety

Intended use

Heed the following when using the vehicle:

- Owner's Manual.
- Information on the vehicle. Do not remove stickers.
- Technical vehicle data.
- The traffic, speed, and safety laws where the vehicle is driven.
- Vehicle documents and statutory documents.

Warranty

The vehicle is technically configured for the operating conditions and registration requirements applicable in the country of first delivery, also known as homologation. If the vehicle is to be operated in a different country it might be necessary to adapt the vehicle to potentially differing operating conditions and registration requirements. Noncompliance with homologation requirements in a certain country may affect warranty coverage. Please consult the New Vehicle Limited Warranty Booklet for further information on warranty matters.

Maintenance and repairs

Advanced technology, for instance the use of modern materials and high-performance

electronics, requires suitable maintenance and repair work.

The vehicle manufacturer therefore recommends having necessary work performed by an authorized service center, e.g., a MINI dealer or service center. If a different repair shop is selected, MINI recommends selecting a workshop that performs the appropriate work such as maintenance and repair according to MINI specifications with properly trained personnel. In the Owner's Manual, such workshops are referred to as "another qualified service center or repair shop".

If work is not carried out properly, for instance maintenance and repair, there is a risk of subsequent damages and related safety risks.

Improperly performed work on the vehicle paintwork can lead to a failure or fault of components, e.g., the radar sensors, and thereby result in a safety hazard.

Parts and accessories

The manufacturer of the vehicle recommends the use of parts and accessory products approved by the manufacturer of the MINI.

Approved parts and accessories, and advice on their use and installation are available from an authorized service center.

MINI parts and accessories were tested by the manufacturer of the MINI for their safety and suitability in MINI vehicles.

The manufacturer of the vehicle warrants genuine MINI parts and accessories.

The manufacturer of the vehicle does not evaluate whether each individual product from another manufacturer can be used with MINI vehicles without presenting a safety hazard, even if a country-specific official approval was issued. The manufacturer of the vehicle does not evaluate

whether these products are suitable for MINI vehicles under all usage conditions.

California Proposition 65 Warning

For vehicles sold in California, the law requires vehicle manufacturers to provide the following warning:

Warning

Engine exhaust and a wide variety of Automobile components and parts, including components found in the interior furnishings in a vehicle, contain or emit chemicals known to the State of California to cause cancer and birth defects and reproductive harm. In addition, certain fluids contained in vehicles and certain products of component wear contain or emit chemicals known to the State of California to cause cancer and birth defects or other reproductive harm. Battery posts, terminals and related accessories contain lead and lead compounds. Batteries also contain other chemicals known to the State of California to cause cancer. Wash your hands after handling. Used engine oil contains chemicals that have caused cancer in laboratory animals. Always protect your skin by washing thoroughly with soap and water. For more information go to www.P65Warnings.ca.gov/passenger-vehicle.

Warning

Operating, servicing and maintaining a passenger vehicle or off-highway motor vehicle can expose you to chemicals including engine exhaust, carbon monoxide, phthalates, and lead, which are known to the State of California to cause cancer and birth defects or other reproductive harm. To minimize exposure, avoid breathing exhaust, do not idle the engine



except as necessary, service the vehicle in a well-ventilated area and wear gloves or wash your hands frequently when servicing the vehicle. For more information go to www.P65Warnings.ca.gov/passenger-vehicle.

Service and warranty

We recommend that you read this publication thoroughly. The vehicle is covered by the following warranties:

- New Vehicle Limited Warranty.
- Rust Perforation Limited Warranty.
- Federal Emissions System Defect Warranty.
- Federal Emissions Performance Warranty.
- California Emission Control System Limited Warranty.

Detailed information about these warranties is listed in the New Vehicle Limited Warranty Booklet.

The vehicle has been specifically adapted and designed to meet the particular operating conditions and homologation requirements in your country and continental region in order to deliver the full driving pleasure while the vehicle is operated under those conditions. If you wish to operate the vehicle in another country or region, you may be required to adapt the vehicle to meet different prevailing operating conditions and homologation requirements. You should also be aware of any applicable warranty limitations or exclusions for such country or region. In such case, please contact Customer Relations for further information.

Maintenance

Maintain the vehicle regularly to sustain the road safety, operational reliability and the New Vehicle Limited Warranty.

Specifications for maintenance measures:

- MINI Maintenance system.
Maintenance, refer to page 378.
- Maintenance Booklet, available online and accessible via a QR code in the New Vehicle Limited Warranty Booklet.
- Warranty and Service Guide Booklet for Canadian models.

If the vehicle is not maintained or is improperly maintained, this could result in serious damage to the vehicle.

A failure to maintain the vehicle or improper maintenance may affect your warranty coverage. Please consult the New Vehicle Limited Warranty Booklet for further information on warranty matters.

Refer to section on engine oil change regarding recommended service intervals for oil changes.

Data memory

General information

Electronic control devices are installed in the vehicle. Electronic control units process data they receive from vehicle sensors, self-generate or exchange with each other. Some control units are necessary for the vehicle to function safely or provide assistance while driving, for instance driver assistance systems. Furthermore, control units facilitate comfort or infotainment functions.

Information about stored or exchanged data can be requested from the manufacturer of the vehicle, in a separate booklet, for example.

Personal reference

Each vehicle is marked with a unique vehicle identification number. Depending on the country, the vehicle owner can be identified with the vehicle identification number, li-

cense plate and corresponding authorities. In addition, there are other ways to associate data collected from the vehicle with the driver or vehicle owner, e.g., the MINI Connected account used.

Operating data in the vehicle

Control units process data to operate the vehicle.

For example, this includes:

- Status messages for the vehicle and its individual components, e.g., wheel RPM, wheel speed, deceleration, lateral acceleration, engaged seat belt indicator.
- Ambient conditions, e.g., temperature, rain sensor signals.

The processed data is only processed in the vehicle itself while the vehicle is being operated. Data is not stored beyond the operating time.

Electronic components, e.g. control units and vehicle keys, contain components for storing technical information. Information about the vehicle condition, component usage, maintenance recommendations, events or faults can be stored temporarily or permanently.

This information generally documents the state of a component, a module, a system, or the surrounding area, for instance:

- Operating states of system components such as fill levels, tire pressure, battery status.
- Malfunctions and faults in important system components, for instance lights and brakes.
- Responses by the vehicle to special driving situations such as airbag deployment or engagement of the driving stability control systems.
- Information on vehicle-damaging events.

The data is required to perform the control unit functions. Furthermore, it also serves to detect and correct malfunctions, and helps the vehicle manufacturer to optimize vehicle functions.

The majority of this data is stored temporarily and is only processed within the vehicle itself. In some circumstances the vehicle may store some data for an additional but limited period of time.

When servicing, for instance during repairs, service processes, warranty cases, and quality assurance measures, this technical information can be read out from the vehicle together with the vehicle identification number.

An authorized service center or another qualified service center or repair shop can read out the information. The diagnostic socket required by law in the vehicle is used to read out data.

The data is collected, processed, and used by the relevant organizations in the service network. The data documents technical conditions of the vehicle, which can be used to determine vehicle maintenance status, and facilitate quality improvement.

Vehicle fault and event memories can be reset by an authorized service center or another qualified service center or repair shop when performing repair or servicing work.

Data entry and data transfer into the vehicle

General information

Depending on the vehicle equipment, comfort and individual settings can be stored in the vehicle and modified or reset at any time.

For example, this includes:

- Settings for the seat and steering wheel positions.
- Chassis and air conditioning settings.

If necessary, data can be transferred to the entertainment and communication system of the vehicle, for instance via smartphone. This includes the following depending on the respective equipment:

- Multimedia data such as music, films or photos for playback in an integrated multimedia system.
- Address book data for use in conjunction with an integrated hands-free system or an integrated navigation system.
- Entered navigation destinations.
- Data on the use of Internet services.

This data can be stored locally in the vehicle or is found on a device that has been connected to the vehicle, e.g., a smartphone, USB stick or MP3 player. If this data is stored in the vehicle, it can be deleted at any time.

This data is only transmitted to third parties upon personal request as part of the use of online services. The transmission depends on the selected settings for the use of the services.

Incorporation of mobile devices

Depending on the vehicle equipment, mobile devices connected to the vehicle, for instance smartphones, can be controlled via the vehicle operating elements.

The sound and picture from the mobile devices can be played back and displayed through the multimedia system. Certain information is transferred to the mobile devices at the same time. Depending on the type of incorporation, this includes, for instance, position data and other general vehicle information. This optimizes the way in which selected apps, for instance navigation or music playback, work.

There is no further interaction between the mobile device and the vehicle such as active access to vehicle data.

How the data will be processed further is determined by the provider of the particular app being used. The extent of the possible settings depends on the respective app and the operating system of the mobile device.

Services

General information

If the vehicle has a wireless network connection, it will enable data to be exchanged between the vehicle and other systems. The wireless network connection is realized via an in-vehicle transmitter and receiver unit or via personal mobile devices brought into the vehicle, for instance smartphones. This wireless network connection enables 'online functions' to be used. These include online services and apps supplied by the vehicle manufacturer or by other providers.

Services from the vehicle manufacturer

Where online services from the vehicle manufacturer are concerned, the corresponding functions are described in the appropriate place, for instance the Owner's Manual or manufacturer's web page. The relevant legal information pertaining to data protection may also be found on the manufacturer's website. Personal data may be used to perform online services. Data is exchanged over a secure connection, for instance with the IT systems of the vehicle manufacturer intended for this purpose.

Any collection, processing, and use of personal data above and beyond that needed to provide the services must always be based on a legal permission, contractual arrangement or consent. It is also possible to activate or deactivate the data connection as a

whole. This excludes functions and services required by law such as Assist systems.

Services from other providers

When using online services from other providers, these services are the responsibility of the relevant provider and subject to their data privacy conditions and terms of use.

The vehicle manufacturer has no influence on the content exchanged during this process. Information on the way in which personal data is collected and used in relation to services from third parties, the scope of such data, and its purpose, can be obtained from the relevant service provider.

Event Data Recorder (EDR)

This vehicle is equipped with an event data recorder (EDR). The main purpose of an EDR is to record, in certain crash or near crash-like situations such as an air bag deployment or hitting a road obstacle, data that will assist in understanding how a vehicle's systems performed. The EDR is designed to record data related to the driving dynamics and safety systems for a short time: max. 30 seconds, typically less.

The EDR in this vehicle is designed to record the following data, for example:

- How various systems in the vehicle were operating.
- Whether or not the driver and passenger seat belts were fastened.
- How far, if at all, the driver was depressing the accelerator and/or brake pedal.
- How fast the vehicle was traveling.

This data can help provide a better understanding of the circumstances in which crashes and injuries occur.

EDR data is recorded by the vehicle only if a nontrivial crash situation occurs; no

data is recorded by the EDR under normal driving conditions and no personal data, for instance name, gender, age, and crash location, are recorded.

However, other parties such as law enforcement could combine the EDR data with the type of personally identifying data routinely acquired during a crash investigation.

To read data recorded by an EDR, special equipment is required, and access to the vehicle or the EDR is needed. In addition to the vehicle manufacturer, other parties such as law enforcement that have the special equipment can read the information if they have access to the vehicle or the EDR.

Vehicle identification number

General information

Depending on the national-market equipment, the vehicle identification number is located in different positions in the vehicle. This chapter describes all possible positions for the series.

Under the hood



The engraved vehicle identification number can be found under the hood on the right-hand side of the vehicle.

Right nameplate



The vehicle identification number is located on the nameplate, on the right side of the vehicle.

Left nameplate



The vehicle identification number is located on the nameplate, on the left side of the vehicle.

Windshield



The vehicle identification number can also be found behind the windshield.

Reporting safety defects

For US customers

The following only applies to vehicles owned and operated in the US.

If you believe that the vehicle has a defect which could cause a crash or could cause injury or death, you should immediately inform the National Highway Traffic Safety Administration NHTSA, in addition to notifying MINI of North America, LLC, P.O. Box 1227, Westwood, New Jersey 07675-1227, Telephone 1-800-831-1117.

If NHTSA receives similar complaints, it may open an investigation, and if it finds that a safety defect exists in a group of vehicles, it may order a recall and remedy campaign.

However, NHTSA cannot become involved in individual problems between you, your dealer, or MINI of North America, LLC.

To contact NHTSA, you may call the Vehicle Safety Hotline toll-free at 1-888-327-4236 (TTY: 1-800-424-9153); go to <http://www.safercar.gov>; or write to: Administrator, NHTSA, 1200 New Jersey Avenue, SE., Washington, DC 20590. You can also obtain other information about motor vehicle safety from <http://www.safercar.gov>.

For Canadian customers

Canadian customers who wish to report a safety-related defect to Transport Canada, Defect Investigations and Recalls, may call the toll-free hotline 1-800-333-0510. You can also obtain other information about motor vehicle safety from <http://www.tc.gc.ca/roadsafety>.

Electric drive

Vehicle features and options

This chapter describes model-specific equipment, systems, and functions that are currently available, or may become available in the future, even if they are not present in the vehicle.

Additional information:

Vehicle equipment, refer to page 8.

Electric drive

Principle

The vehicle features a high-voltage system that consists of an electric motor on the front axle and a high-voltage battery, among other things.

With ALL4, a second electric motor is located on the rear axle.

The electric drive makes it possible to operate the vehicle with zero emissions.

On the go, the energy recovery ensures that only little energy is lost when braking.

General information

This system is unique in that:

- The special high-voltage battery supplies power to the electric motors and comfort functions.
- The high-voltage battery is charged via the charging cable when parked and via energy recovery when driving.
- The vehicle can be charged very rapidly at special charging stations. Charging is also possible at domestic socket outlets.
- When the vehicle decelerates, the electric motors act as alternators and con-

vert the kinetic energy released into electric energy. The high-voltage battery is partially recharged with this electrical energy in order to increase the range.

- The front electric motor drives the front wheels.

With ALL4, the vehicle has an electric all-wheel drive. The rear wheels are driven by a second electric motor.

Overview

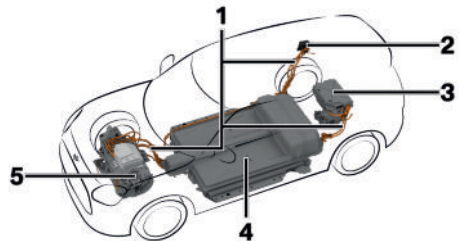

- 1 High-voltage cables, orange
- 2 Charging socket
- 3 Drive unit
- 4 High-voltage battery
- 5 Drive unit

Functions

Electric driving

The vehicle is driven electrically.

The accelerator pedal can be used for acceleration and deceleration.

When decelerating, the electric motors act as an alternator and charge the high-voltage battery. With an anticipatory driving style, this function can be used to recover energy very efficiently and drive comfortably.

Energy recovery

The high-voltage battery is charged via energy recovery when driving.

Energy recovery is also called recuperation.

The electric motors act as alternators and convert the vehicle's kinetic energy into electrical energy.

The high-voltage battery can be charged when driving in various situations:

- The accelerator pedal is only slightly depressed.
- The accelerator pedal is not depressed.
- The pressure on the accelerator pedal is strongly reduced.

Views on the Interaction Unit

The views on the Interaction Unit provide information about the drive system's current condition and visualize the system's usage.

Additional information:

Displays, refer to page 142.

Saving energy while driving and maximizing range

General information

The longest possible range can only be achieved with an energy-efficient driving style. The electric drive provides various functions that promote an energy-efficient driving style. The electric drive functions assist in checking the range and increase it, if necessary.

Before driving

The electric drive allows preconditioning of the vehicle before the start of a journey. Pre-conditioning the vehicle while charging at a Wallbox or DC charging station provides more range than using only the air conditioning during the drive.

The vehicle is preconditioned while it charges in order to generate the greatest possible range by departure.

Additional information:

Pre-conditioning, refer to page 291.

Trip planning and special functions of the navigation system

Several special functions of the navigation system support trip planning taking into account the electric range:

- The current range can be displayed in the navigation system map view.
- When entering a destination, charging stations can be selected as points of interest.
- The navigation system helps you to find and add a charging station along the desired route.

Additional information:

Owner's Manual for Navigation, Entertainment, and Communication, refer to page 6.

While driving

To save energy while driving and maximize the range, note the following:

- To increase the range, activate Green Mode.
- Note the information on expected range.
- Follow the instructions for vehicle range.
- Follow the instructions for efficient driving.
- Activate adaptive energy recovery.
- Follow the instructions for the efficiency trainer.
- Use the battery heat management system to prepare the high-voltage battery for an upcoming charging process.

Additional information:

- Green Mode, refer to page 328.
- Increasing the range, refer to page 327.
- Adaptive recuperation, recuperative braking, refer to page 327.
- Efficiency trainer, refer to page 329.
- Preparing the high-voltage battery, refer to page 339

After the trip

After driving, note the following:

- Charge the vehicle and plan the next trip.
- Take all indicated precautions for extended stationary periods.

Additional information:

- Charge vehicle, refer to page 332.
- Service life of high-voltage battery, long stationary periods, and vehicle shut-down, refer to page 345.

MINI app

The MINI app provides mobility-based services and applications.

Safety of the high-voltage system

Follow all safety instructions for the high-voltage system.

Additional information:

Safety of the high-voltage system, refer to page 19.

Operating noises

Operating noises are produced by the electrical system. These operating noises may be produced in situations like the following:

- When cooling the high-voltage battery while charging.
- When cooling the high-voltage battery while drive-ready state is on.
- When preconditioning the vehicle interior.

High-voltage battery, long stationary periods

Follow the instructions for taking the vehicle out of service and for longer stationary periods.

Additional information:

Service life of high-voltage battery, long stationary periods, refer to page 345.

Safety of the high-voltage system

Vehicle features and options

This chapter describes model-specific equipment, systems, and functions that are currently available, or may become available in the future, even if they are not present in the vehicle.

Additional information:

Vehicle equipment, refer to page 8.

Working on the vehicle

Principle

Work on the vehicle makes it possible to perform corresponding service and maintenance work for maintaining the safety of the high-voltage system.

General information

The manufacturer of the vehicle recommends that no changes be made to the vehicle, for instance installation of retrofitting accessories, that will have an effect on the vehicle's high-voltage system.

Safety information

Warning

Improperly performed work, in particular maintenance and repair on the high-voltage system, can lead to electric shock. There is a risk of injury, fire and danger to life.

It is recommended that the work on the vehicle, in particular maintenance and repair, is performed by an authorized service center or another qualified service center or repair shop.

Contact with water

The high-voltage system is typically safe even in the following example situations:

- Water in the footwell, e.g., after the window was left open during a rainstorm.
- The vehicle is in water up to the permitted height for driving through water.
- Fluid is leaking in the cargo area.

Additional information:

General driving instructions, driving through water, refer to page 312.

Contact with ground

Note the ground clearance to prevent damage to the high-voltage system. If the vehicle floor has come into contact with the ground, have the vehicle checked by an authorized service center or another qualified service center or repair shop.

Additional information:

General driving instructions, ground clearance, refer to page 312.

High-voltage battery monitor

Principle

The temperature of the high-voltage battery is monitored.

Warnings are issued when the high-voltage battery temperature is unusually high.

Safety information

Warning

An unusually high temperature of the high-voltage battery can cause a formation of gas and smoke. There is a risk of injury or danger to life. In case of noticeable unusual odor or smoke formation, refer to the notes for actions in the event of a message.

High temperature message

While driving

A Check Control message appears on the Interaction Unit when the high-voltage battery temperature is too high while driving.

When charging and parking

Depending on national-market version: If the temperature of the high-voltage battery is too high during or shortly after charging, the vehicle horn sounds and the vehicle lighting may flash.

Actions in the event of a message

While driving

If a Check Control message appears on the Interaction Unit indicating that the high-

voltage battery temperature is too high while driving, proceed as follows:

1. Stop immediately.
2. Park vehicle in a safe place.
3. Exit the vehicle.
4. Establish and keep a sufficient distance to the vehicle.
5. Alert emergency personnel.

During and shortly after the charging process

If the horn sounds and the vehicle lighting flashes to indicate that the high-voltage battery temperature is too high during or shortly after charging, proceed as follows:

1. If necessary, exit the vehicle.
2. Establish and keep a sufficient distance to the vehicle.
3. Alert emergency personnel.

Automatic deactivation

If an accident occurs, the high-voltage system is switched off automatically to prevent risk of danger to occupants and other road users.

Additional information:

What to do after an accident, refer to page [388](#).

Getting in

Opening and closing

Vehicle key



Buttons on the vehicle key.

Icon	Meaning
	Unlock.
	Lock. Pre-conditioning, refer to page 291. Displaying the charging screen, refer to page 156.
	Open the cargo area.
	Panic mode. Pathway lighting, refer to page 166.

Accessing the vehicle interior

Unlocking with the vehicle key

Press the unlock button on the vehicle key.

If only the driver's door and charging socket flap have been unlocked due to the settings,

press the button on the vehicle key again to unlock the other vehicle access points.

After opening one of the front doors, the vehicle is ready for operation.

Locking with the vehicle key

1. Close the driver's door.

2. Press the lock button on the vehicle key.

All vehicle access points are locked.

Buttons for the central locking system

Overview

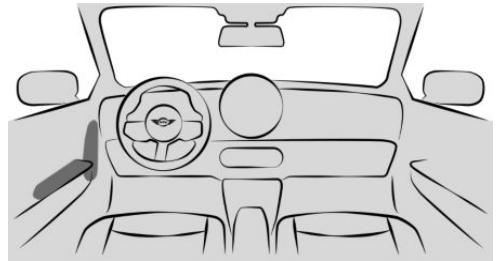

The central locking system buttons are located on the driver's door.

Lock the vehicle.

Unlock the vehicle.

Locking the vehicle

With the doors closed, press the lock button on the driver's door.



The vehicle is not secured against theft when locking.



Unlocking the vehicle



Press the unlock button on the driver's door.

Panic mode

You can trigger the alarm system if you find yourself in a dangerous situation.

-  Press and hold the panic mode button on the vehicle key for at least 3 seconds.
-  Press the panic mode button on the vehicle key three times in quick succession.

To switch off the alarm: press any button.

Access to the cargo area

Opening the cargo area

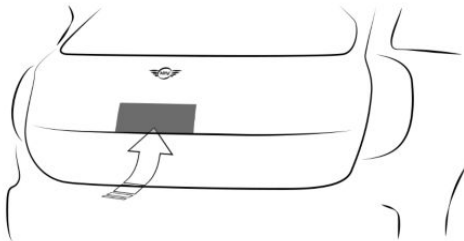

- Unlock the vehicle, then press the Open button on the outside of the cargo area.
-  On the vehicle key, press and hold the button for opening/closing the cargo area for approx. 1 second.

Depending on the setting, the doors may be unlocked.

Closing the cargo area

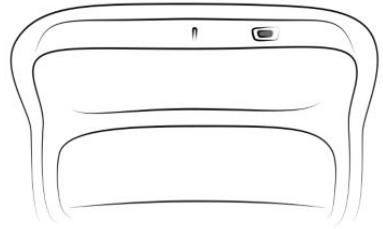

Press the button for closing the cargo area on the inside of the tailgate.

Displays, operating elements

In the vicinity of the steering wheel



- 1 Lights
- 2 Wipers
- 3 Horn

Indicator/warning lights

The indicator/warning lights can illuminate in a variety of combinations and colors.

Several of the lights are checked for proper functioning and illuminate temporarily when drive-ready state is turned on.

Driver's door

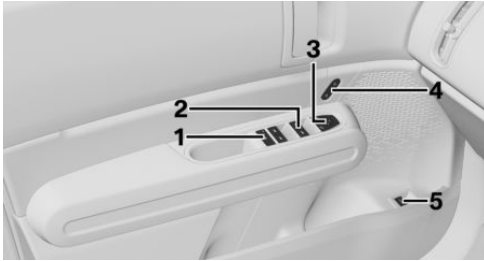

- 1 Safety switch
- 2 Power windows
- 3 Exterior mirror adjustment button
- 4 Central locking system
- 5 Cargo area

Switch console

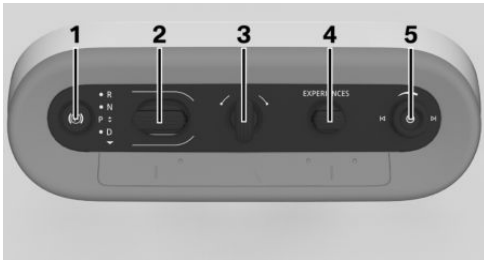

- 1 Parking brake
- 2 Selector lever
- 3 Start/Stop switch
- 4 MINI Modes
- 5 Volume button

MINI Interaction Unit

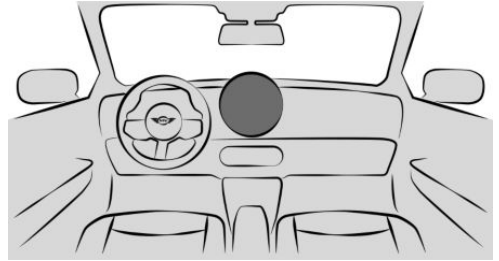

The Interaction Unit is located on the instrument panel above the center console.

Principle

The Interaction Unit consists of a central round display with functions that can be operated by touch.

The Interaction Unit's main menu is divided into different areas, e.g., menu bar, status information, and widgets.

MINI Intelligent Personal Assistant

Principle

The MINI Intelligent Personal Assistant is a personal assistant that operates various vehicle functions by means of natural spoken commands.

Activating the voice control system

1.  Briefly press the microphone button on the steering wheel.
2. Say the desired command.

Canceling voice control

-  Press the microphone button on the steering wheel again.
- Say the following command: >Cancel<

Set-up and use

Seats, mirrors and steering wheel

Manually adjustable seats

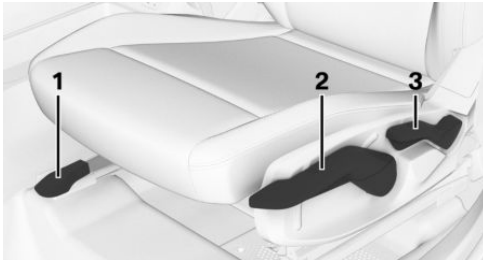

- 1 Longitudinal direction
- 2 Height
- 3 Backrest tilt

Electrically adjustable seats

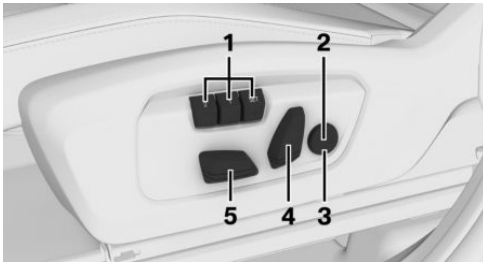

- 1 Memory function
- 2 Lumbar support
- 3 Seat massage
- 4 Backrest tilt
- 5 Longitudinal direction/height/seat tilt

Adjusting the head restraint

Adjusting the height

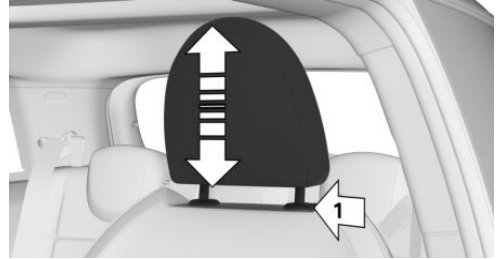

- To raise the height of the head restraint, push the head restraint upward.
- To lower the height of the head restraint, press the release button on the backrest, arrow 1, then push the head restraint downward.

Adjusting the distance

The backrest tilt is used to set the distance between the head restraint and the back of the seat occupant's head.

Adjust the distance so that the head restraint is as close as possible to the back of the head.

Adjusting the exterior mirrors





Icon	Meaning
	Fold the exterior mirror in and out.
	Adjust the exterior mirrors.
	Select left exterior mirror, Automatic Curb Monitor.
	Select right exterior mirror.

Adjusting the steering wheel

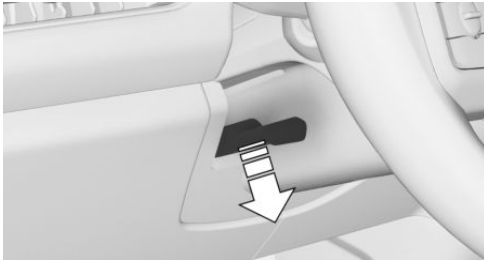

1. On the steering column, press the release lever all the way down.
2. Grip the steering wheel with both hands and move the steering wheel to the preferred height and angle to suit your seat position.
3. Fold the lever back up.

Memory function

Principle

The following settings can be stored and, if necessary, retrieved using the memory function:

- Seat position.
- Exterior mirror adjustment.
- Depending on the equipment: height of the Head-up display.

Overview



The memory buttons are located on the front seats.

Storing settings

1. Set the desired position.
2.  Press the SET button on the seat. The LED illuminates.
3. Press memory button 1 or 2 while the LED is illuminated. A successful save is indicated by a signal tone.

Calling up settings

Press the desired memory button 1 or 2.

Infotainment



Navigation and guidance

Guidance can be started via the quick search.

1. Go to the Navigation menu.
2. Select the search field.
3. Enter your desired destination.
4. Start destination guidance.
More information may be displayed.

Entertainment

The following operating elements are provided on the switch cluster and Interaction Unit:

Button	Function
	<p>Turn the volume button to adjust the volume.</p> <p>Press the volume button to turn off sound output. Pressing the button again restores the previous volume.</p> <p>Push the volume button once to left/right: Change station/track.</p>
	Change the entertainment source.

Using the mobile phone

General information

Once a mobile phone connects with the vehicle, this mobile phone can be operated using the Interaction Unit and steering wheel buttons.

Activate Bluetooth® on the mobile phone.

Connecting via Bluetooth®

A mobile phone can be paired with the vehicle via Bluetooth.

Google Fast Pair can be used on Android devices that have the necessary software version. To do so, follow the instructions on the Interaction Unit and on the smartphone display.

1. Go through the menu as follows: Apps menu / "All" / "Mobile devices" / "Connect new device".

Devices detected by the vehicle are shown on the Interaction Unit.

If necessary, select Google Fast Pair on the smartphone display and follow the instructions on the device. Steps 2 and 3 can then be skipped.

2. Select the desired mobile phone.
3. Compare the control number shown on the Interaction Unit with the control number on the mobile phone's display and make sure that they match.

4. If necessary, select connection mode: "Continue with MINI Interaction Unit"

The mobile device is displayed in the device list.

Accepting a call

Depending on the equipment, incoming calls can be answered in several ways.

- Via the Interaction Unit:

 "Accept"

-  Press the telephone function button on the steering wheel.

Dialing a number

The Interaction Unit can be used to dial a telephone number.

1. Go through the menu as follows: Apps menu / "All" / "Telephone" / "Dial".
2. Enter the desired digits.
3.  Select the icon for calling. The connection is established via the mobile phone to which this function has been assigned.

On the road

Driving

Drive-ready state

General information

Using electric drive-ready state to start the vehicle corresponds to starting the engine in conventional vehicles.

Turning on the drive-ready state

1. Close the driver's door.
2. Depress the brake pedal.

3.  Turn the Start/Stop button on the switch cluster.

A signal tone sounds. Drive-ready state is switched on.

Interaction Unit view



The READY display indicates that the vehicle is ready for driving.

Turning off drive-ready state

After stopping the vehicle:

1. Apply the brake and push the parking brake button.
2.  Turn the Start/Stop button on the switch cluster.

The READY indicator goes out and a signal tone sounds.

The drive-ready state is switched off automatically if the driver's seat belt is not buckled when the driver's door is opened.

Drive-ready state in detail

Functional requirements

Driving is possible when the following prerequisites are met:

- The high-voltage battery has sufficient charge.
- The driver's door is closed.
- The charging cable is disconnected.

Driving

1. Switch on drive-ready state.
2. Depress the brake pedal.
3. Engage selector lever position D, B, or R.
4. Depress the accelerator pedal to drive.

Engaging a selector lever position

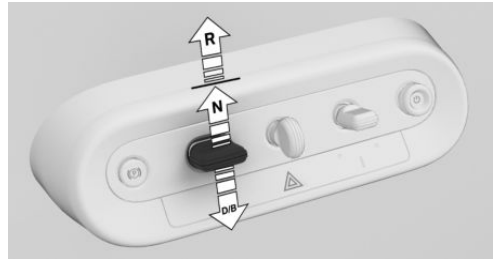

- Gear position D.
- N neutral.
- R reverse gear.
- B gear position with high energy recovery.

To prevent the vehicle from moving after engaging drive or reverse, maintain pressure on the brake pedal until you are ready to drive off.

Only engage selector lever position R when the vehicle is stationary.

In selector lever position B, the vehicle decelerates more sharply than selector lever position D when rolling to a stop.

Engaging selector lever position P

Only push the parking brake button when the vehicle is stationary.

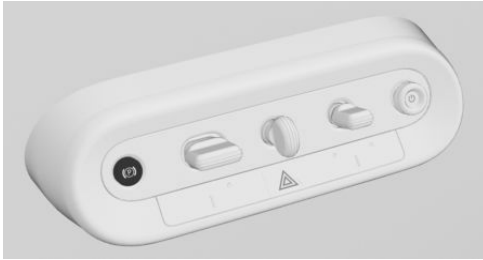

 To engage selector lever position P and the parking brake, press the parking brake button on the switch cluster.

The parking brake is applied and the transmission lock is engaged.

Parking brake

Setting the parking brake

 To engage the parking brake, press the parking brake button on the switch cluster.

The LED illuminates.

The parking brake is engaged and transmission lock is engaged.

Releasing the parking brake

 Press the parking brake button with selector lever position P engaged and drive-ready state on.

The LED and the indicator light go out.

The parking brake is released.

Parking

Make sure the parking brake is engaged.

Light and view

Turn signal, high-beam headlights, headlight flasher

Turn signal

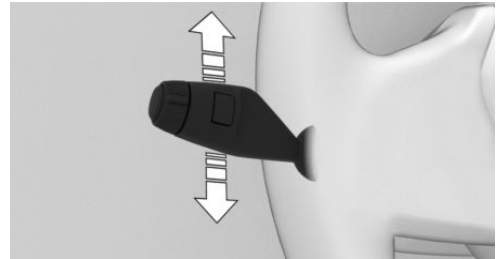

- To flash the turn signal, push the turn signal lever up or down past the resistance point.
- For one-touch signaling: Lightly tap the turn signal lever up or down.
- To flash the turn signal briefly: Push the turn signal lever to the resistance point and hold it there for as long as you wish to indicate a turn.

High-beam headlights, headlight flasher

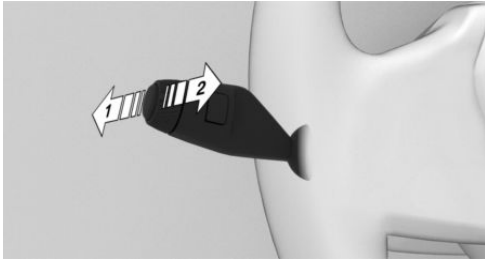

- To turn on the high-beam headlights, push the turn signal lever forward, arrow 1.
The high-beam headlights illuminate when the low-beam headlights are switched on.
- To turn off the high-beam headlights or operate the headlight flasher, pull the turn signal lever backward, arrow 2.

Lights and lighting

Buttons on turn signal lever

Icon	Function
	Exterior lighting menu.
	Low-beam headlights.
	Automatic headlight control.
	Exterior lighting off.

Functions via the Interaction Unit

Icon	Function
	Automatic headlight control.
	Low-beam headlights.
	Exterior lighting off.
	Automatic High Beam Assistant.
	Parking lights.
	Left roadside parking light.
	Right roadside parking light.

Window wiper system

Turning on window wiper system

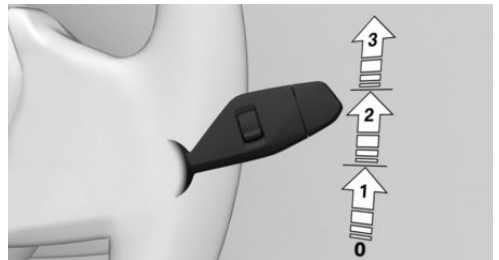

To turn on the wiper system, push the wiper lever upward to the desired position.

Position	Function
Position 0.	Rest position of wipers.
Position 1.	Rain sensor mode.

Position	Function
Position 2.	Normal wiper speed.
Position 3.	Fast wiper speed.

Turning off the window wiper system and flick wipe

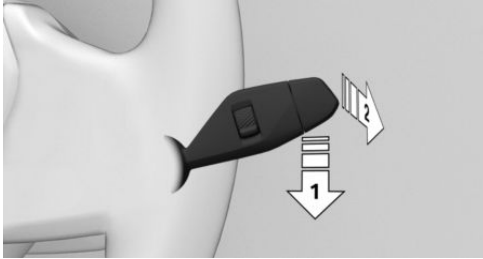

To turn off the wipers or to activate flick wiping, proceed as follows:

- To turn off: Push the wiper lever downward, arrow 1, until position 0 is reached.
- To flick wipe: Push the wiper lever downward from position 0, arrow 1, and push the wiper lever forward to position 0 or position 1, arrow 2.

The wiper lever returns to its initial position when released.

Activating/deactivating rain sensor

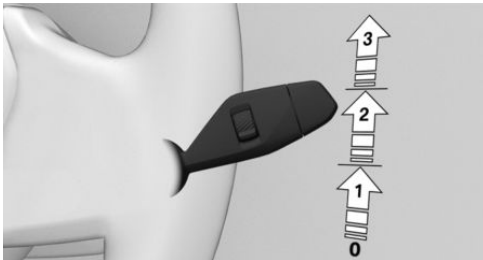

To activate the rain sensor: Push the wiper lever upward from position 0, arrow 1, once.

To deactivate the rain sensor: Push the wiper lever back to position 0.

Adjusting the rain sensor sensitivity

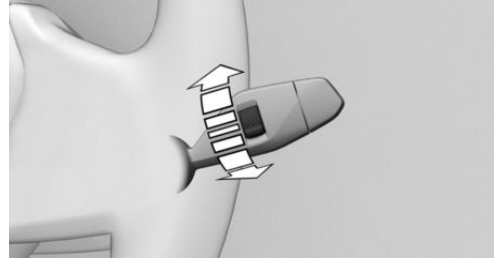

To adjust the sensitivity of the rain sensor, turn the knurled wheel on the wiper lever.

Cleaning the windshield

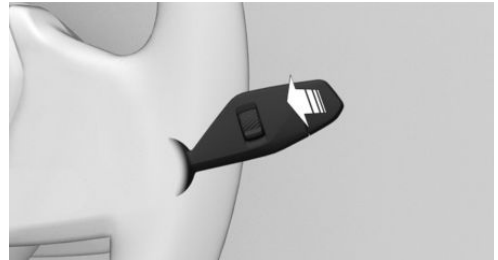

To clean the windshield, pull the wiper lever back.

Rear wiper

Switching on the rear wiper

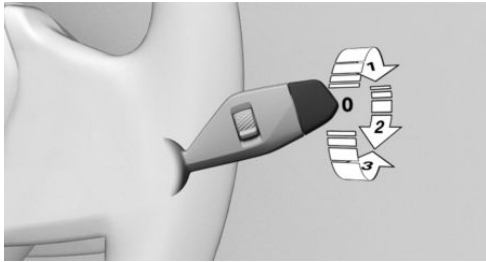

To turn on the rear wiper, rotate the outer switch on the wiper lever upward.

Switch position	Function
Position 0.	Rest position of the wiper.
Position 1.	Intermittent operation. When reverse gear is engaged, the system switches to continuous operation.

Clean the rear window

To clean the rear window, turn the outer switch on the wiper lever as follows:



- In rest position: Turn the switch downward, arrow 3. The switch returns to its rest position when released.
- In intermittent operation: Turn the switch further, arrow 2. The switch automatically returns to its interval position when released.

Climate control

Climate control functions



Functions in the Climate menu

Icon	Function
	Turn the climate control system on/off.
AUTO	Automatic program.
72.0°F	Temperature.
	Air flow.
	Air distribution.
A/C	Air conditioning.
MAX A/C	Maximum cooling.
	Air recirculation mode.
	Automatic recirculated-air control.
	Fresh air.
SYNC	SYNC program.

Icon	Function
	Seat heating.
	Steering wheel heating.

Buttons, automatic climate control



Icon	Function
	Defrost function.
	Rear window defroster.

Intermediate stop

Charging the vehicle

Depending on national-market version, use a mode 2 charging cable, fast charging cable (mode 3), or the permanently installed cable of a charging station to charge the vehicle.

The charging cable can be stowed in the cargo area, for instance under the cargo floor panel or in a bag.

Before disconnecting and connecting a charging cable, clean the area between the charging socket flap and charging socket, as well as the charging cable plug, as necessary, e.g., remove snow.

If necessary, unlock the charging cable before removing.

The charging status is indicated on the indicator light on the charging socket.

When the charging socket is not in use, keep the charging socket flap and, if necessary, the charging socket cover closed.

Wheels and tires

Tire pressure specifications

The tire pressure table contains all tire inflation pressure specifications for given tire sizes at ambient temperature.

After correcting the tire pressure

If vehicle is equipped with the Tire Pressure Monitor, corrected tire pressures are applied automatically. Make sure that the correct tire settings have been made. When using tires not listed in the tire inflation pressure specifications on the Interaction Unit, reset the Tire Pressure Monitor.

If equipped with a flat tire monitor, reinitialize the flat tire monitor.

Checking the tire pressure

Regularly check the tire inflation pressure and correct it as needed:

- At least twice a month.
- Before embarking on an extended trip.



Providing assistance

Hazard warning system



The hazard warning system button is located on the switch cluster.

MINI Connected

MINI Assistance

Contact MINI Assistance for information and support for all aspects of the vehicle.

1. Go through the menu as follows: Apps menu / "All" / "MINI Assist".
2. Select the desired service, as necessary.
A voice connection to the selected service is established.

MINI Teleservices

Teleservices are services that help to maintain vehicle mobility.

Teleservices can comprise the following services:

- MINI Roadside Assistance.
- MINI Accident Assistance.
- Teleservice Call.
- An authorized service center.

Dashboard

Vehicle features and options

This chapter describes model-specific equipment, systems, and functions that are currently available, or may become available







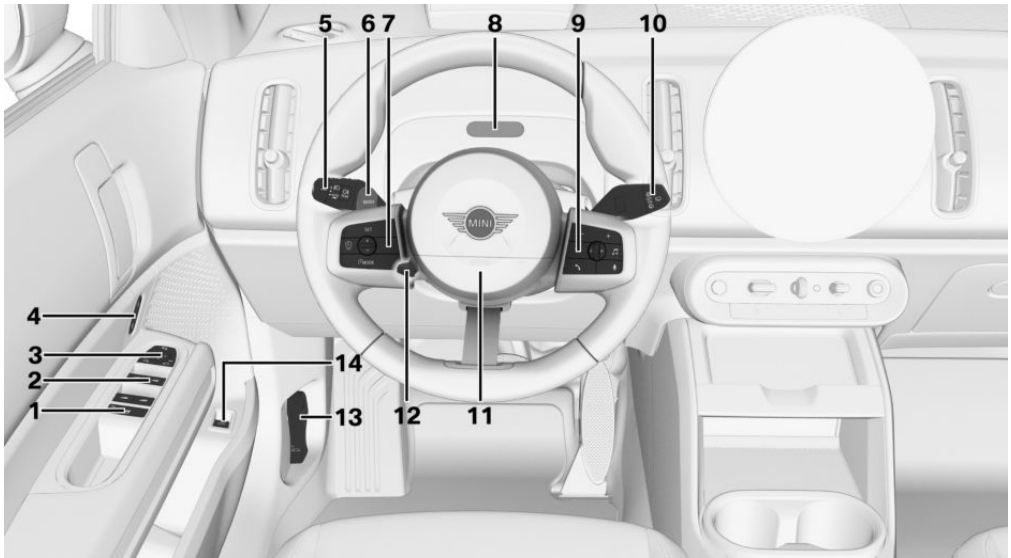

in the future, even if they are not present in the vehicle.























Additional information:

Vehicle equipment, refer to page 8.

In the vicinity of the steering wheel



- | | |
|---------------------------------------------------------------------------------------------------------------------------------------------------------------------------------------------------------------------------------------------------------------------------------------------------------------------------------------------------------------------------------------------|----------------------------------------------------------------------------------------------------------------------------------------------------------------------------------------------------------------------------------------------------------------------------------------------------------------------------------------------------------------------------------------------------------------------------------------------------------------------------------------------------------------------------------------------------------------------------------------------------------------------------------------------------------------------------------------------------------------------------------------------------------|
| <p>1  Safety switch 99</p> <p>2  Power windows 97</p> <p>3 Exterior mirror adjustment button 115</p> <p>4 Buttons for the central locking system 92</p> | <p>5  Unlocking</p> <p> Locking</p> <p>5  Turn signal lever and light</p> <p> Exterior lighting menu 163</p> <p> Automatic High Beam Assistant 161</p> <p> Low-beam headlights 164</p> |
|---------------------------------------------------------------------------------------------------------------------------------------------------------------------------------------------------------------------------------------------------------------------------------------------------------------------------------------------------------------------------------------------|----------------------------------------------------------------------------------------------------------------------------------------------------------------------------------------------------------------------------------------------------------------------------------------------------------------------------------------------------------------------------------------------------------------------------------------------------------------------------------------------------------------------------------------------------------------------------------------------------------------------------------------------------------------------------------------------------------------------------------------------------------|

- | | | | |
|-------------------------------------------------------------------------------------|-------------------------------------------------------------------------------------------------|-------------------------------------------------------------------------------------|--------------------------------------------------------------------------------------------------------------------------------------------------------|
|  | Driving lights automatic 164
Adaptive lighting functions 167 |  | Telephone, see Owner's Manual for Navigation, Entertainment and Communication 6 |
|  | Exterior lighting off 164 |  | Using selection lists 152
Accessing and resetting trip data 142
Resetting the G-Meter values 158 |
|  | Turn signal 160 | | |
|  | High-beam headlights, headlight flasher 160 | | |
| 6 | Sport Boost function 134 | | |
| 7 | Steering wheel buttons, left | | |
|  | Turn speed control systems on/off 223 | | |
|  | Select speed control system 223 | | |
|  | Store speed 223 | | |
|  | Adjusting the speed 223 | | |
| 8 | Driver Attention Camera 214 | | |
| 9 | Steering wheel buttons, right | | |
|  | Shortcuts 52 | | |
|  | Volume, see Owner's Manual for Navigation, Entertainment and Communication 6 | | |
|  | Audio, see Owner's Manual for Navigation, Entertainment, Communication 6 | | |
|  | Voice control, MINI Intelligent Personal Assistant 55 | | |
| | | 10 | Wiper lever |
| | |  | Wipers 170 |
| | |  | Rain sensor 171 |
| | |  | Cleaning the windshield 172 |
| | |  | Rear wiper 172 |
| | |  | Clean the rear window 172 |
| | | 11 | Horn, entire surface |
| | |  | |
| | | 12 | Adjusting the steering wheel 117 |
| | | 13 | Unlocking the hood 374 |
| | |  | |
| | | 14 | Opening and closing cargo area 84 |
| | |  | |

In the vicinity of the center console

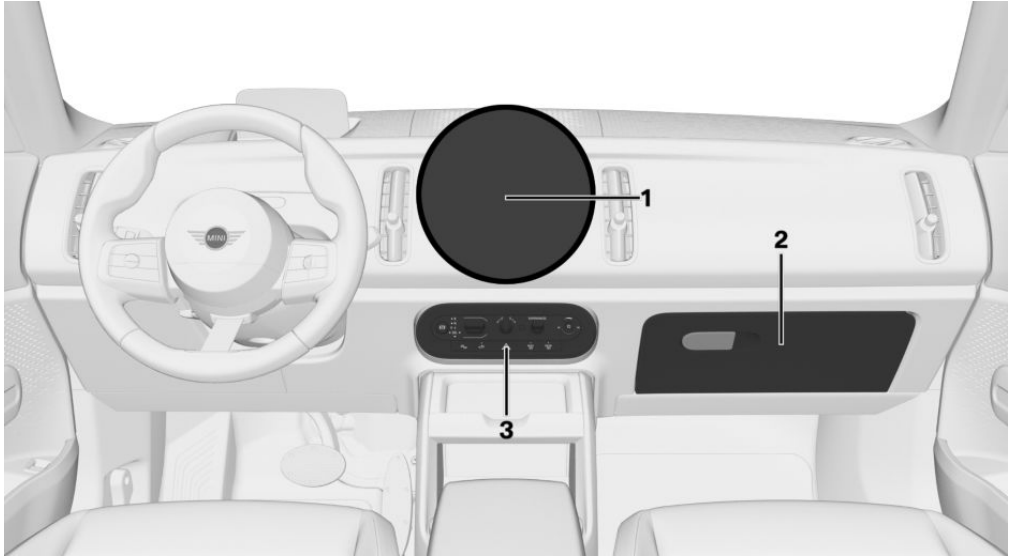

- 1 MINI Interaction Unit [49](#)
- 2 Glove compartment [300](#)
- 3 Switch console



Parking brake [137](#)



Selector lever [128](#)



Turning drive-ready state on/off [127](#)



MINI Modes [135](#)



Volume button, see Owner's Manual for Navigation, Entertainment, Communication [6](#)



Vehicle settings menu [55](#)



Parking assistance systems [249](#)



Hazard warning system [384](#)



Defrost function [288](#)







Rear window defroster [289](#)

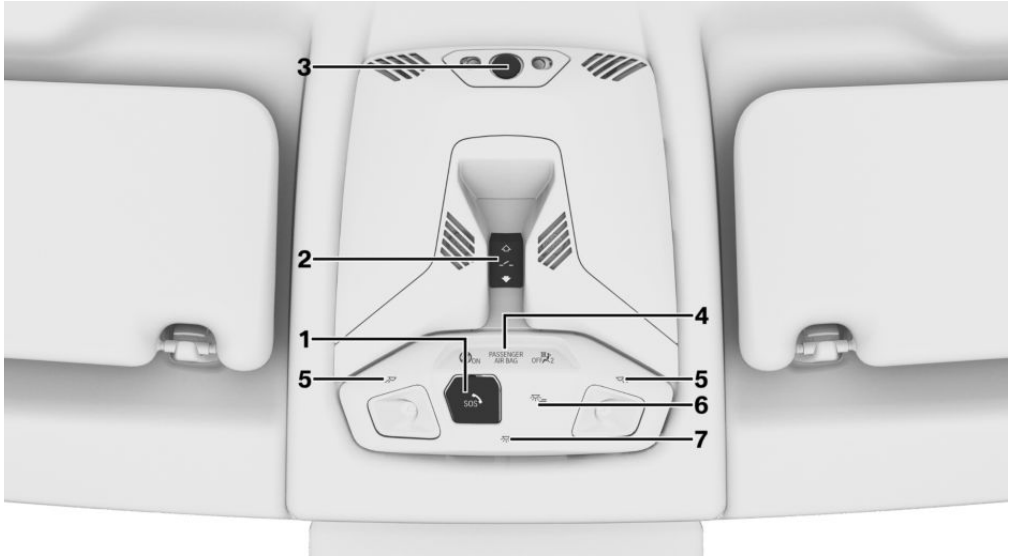

In the vicinity of the headliner



- | | | | | | |
|---|-------------------------------------------------------------------------------------|-------------------------------------------------------------|---|-----------------------------------------------------------------------------------|-------------------------------------------|
| 1 |  | Emergency Call, SOS 386 | 6 |  | Interior lighting menu 55 |
| 2 | | Glass sunroof 100 | 7 |  | Interior lights 168 |
| 3 | | Interior camera 296 | | | |
| 4 |  | Indicator light, front passenger airbag 177 | | | |
| 5 |  | Reading lights 168 | | | |

Sensors of the vehicle

Vehicle features and options

This chapter describes model-specific equipment, systems, and functions that are currently available, or may become available in the future, even if they are not present in the vehicle.

Additional information:

Vehicle equipment, refer to page 8.

Overview

Depending on the equipment, the following cameras and sensors are installed in the vehicle:

- Front camera.
- Camera behind the windshield.
- Exterior mirror cameras.
- Rearview camera.
- Front radar sensor.
- Side radar sensors, front.
- Side radar sensors, rear.
- Ultrasonic sensors in the front/rear bumpers.
- Ultrasonic sensors at the sides.

Cameras

Front camera



The front camera is located above the license-plate carrier.

Camera behind the windshield



The camera behind the windshield is located near the interior mirror.

Top view cameras

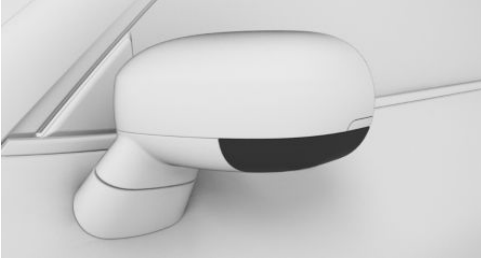

One exterior mirror camera is located at the bottom of each exterior mirror housing.

Rearview camera



The rearview camera is located in the handle strip on the rear of the vehicle.

Functional requirement of the cameras

For the cameras to function correctly, the area around the cameras must be clean and free.

Additional information:

- Washing the vehicle, refer to page 392.
- Vehicle care, refer to page 394.

System limits of the cameras

The cameras may not work properly, e.g., show something that is incorrect, in the following situations:

- In heavy fog, wet conditions, or snow-fall.
- On steep hilltops or in sharp dips in the road.
- In tight curves.
- When the camera field of view is covered, for instance by a fogged up windshield or labels.
- If the camera lens is dirty or damaged.
- With exterior mirrors folded in.
- With open doors or open cargo area.
- When driving toward bright lights or strong reflections, e.g., setting sun.
- When it is dark outside.
- The camera has overheated due to excessive temperatures and temporarily turned off.
- During calibration of the camera immediately after vehicle delivery.

If applicable, a Check Control message will be displayed when the system limits are reached.

Radar sensors

Safety information

Warning

The vehicle radar sensors and thus also the driver assistance systems can be impaired by external influences, e.g., interference. There is a risk of accident, injury, or property damage. Watch the surrounding traffic situation closely, be ready to take over steering and braking at any time, and actively intervene where appropriate.



Front radar sensor



The front radar sensor is located above the license-plate carrier.

Radar sensors, side, front

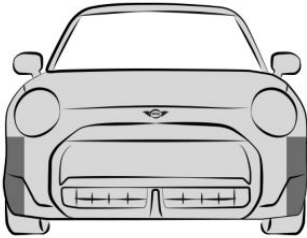

The radar sensors are located on the side of the front bumper.

Radar sensors, side, rear



The radar sensors are located on the side of the rear bumper.

Functional requirement of the radar sensors

For the radar sensors to function correctly, the area around the radar sensors must be kept clean and free.

Additional information:

- Washing the vehicle, refer to page [392](#).
- Vehicle care, refer to page [394](#).

System limits of the radar sensors

The function of the radar sensors may be restricted or not available, for instance in the following situations:

- In case of dirty sensors.
- In case of iced-up sensors.
- If sensors are covered such as by labels, films or a license-plate carrier.
- If the sensor is not aligned correctly, for instance due to parking damage.
- If the radiation range of the sensors is covered, e.g., by protruding cargo.
- When the field of view of the sensors is covered, e.g., by garage walls, hedges, snow hills, vehicles or trailers.
- After improper paint work on the vehicle in the area of the sensors.
- On steep hilltops or in sharp dips in the road.

If applicable, a Check Control message will be displayed when the system limits are reached.

Ultrasonic sensors

Ultrasonic sensors, front

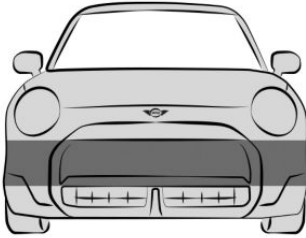

The ultrasonic sensors of the parking assistance systems are located in the front bumper.

Ultrasonic sensors, rear



The ultrasonic sensors of the parking assistance systems are located in the rear bumper.

Ultrasonic sensors, side

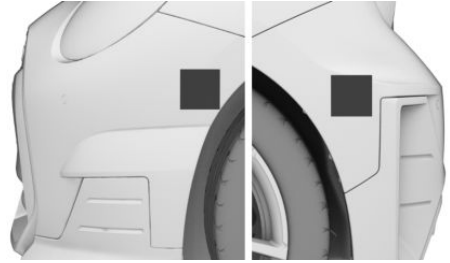

The ultrasonic sensors for the parking assistance systems are located on the sides of the front and rear bumpers.

Functional requirement of the ultrasonic sensors

For the ultrasonic sensors to function correctly, the area around the ultrasonic sensors must be kept clean and free.

Additional information:

- Washing the vehicle, refer to page [392](#).
- Vehicle care, refer to page [394](#).

System limits of the ultrasonic sensors

The detection of objects with ultrasonic measurements can run into physical limits, e.g., in the following situations:

- If the sensors are dirty or covered, e.g., by stickers.
- If the sensor is not aligned correctly, for instance due to parking damage.
- After improper paint work on the vehicle in the area of the sensors.
- For small children and animals.
- For people with specific clothing, e.g., coat.
- With obstacles and persons at the edge of the lane.
- In case of external interference with the ultrasonics, for instance from passing



vehicles, loud machines or other ultrasonic sources.

- Under certain weather conditions, e.g., high moisture, wet conditions, snowfall, cold, extreme heat, or strong wind.
- With tow bars and trailer hitches of other vehicles.
- With thin or wedge-shaped objects.
- With moving objects.
- For elevated, protruding objects, e.g., wall ledges.
- With objects with corners, edges, and smooth surfaces.
- In the case objects with fine surfaces or structures, e.g., wire mesh fences.
- For objects with porous surfaces.
- With small and low objects, e.g., boxes.
- Low objects already displayed, for instance curbs, can be outside of the detection ranges of the sensors.
- With soft obstacles or obstacles covered in foam material.
- With plants and bushes.
- In automatic car washes.
- For bumps, e.g., speed bumps.
- If there are large amounts of exhaust gas.
- Cargo that extends beyond the perimeter of the vehicle is not taken into account by the ultrasonic sensors.
- When the trailer hitch cover is not on straight.

If applicable, a Check Control message will be displayed when the system limits are reached.

Operating state of the vehicle

Vehicle features and options

This chapter describes model-specific equipment, systems, and functions that are currently available, or may become available in the future, even if they are not present in the vehicle.

Additional information:

Vehicle equipment, refer to page 8.

General information

Depending on the situation, the vehicle is in one of the three states:

- Idle state.
- Standby state.
- Drive-ready state.

Overview

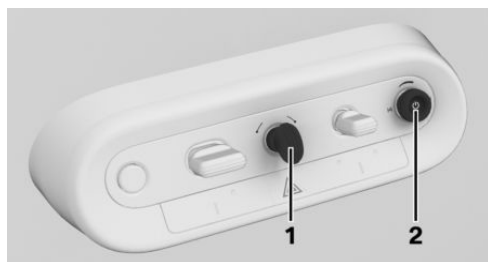

- 1 Start/Stop switch
- 2 Volume button, setting idle state

Idle state

Principle

The vehicle switches off when set to idle state.

The vehicle is in idle state prior to opening from the outside and after exiting and locking.

Safety information

Warning

An unsecured vehicle can begin to move and possibly roll away. There is a risk of accident, injury, and property damage. Before leaving the vehicle, secure the vehicle against rolling away.

In order to ensure that the vehicle is secured against rolling away, follow the following:

- Set the parking brake.
- Automatic transmission: Make sure that selector lever position P is engaged.
- On uphill grades or on downhill slopes, turn the front wheels in the direction of the curb.
- On uphill grades or on downhill slopes, also secure the vehicle, for instance with a wheel chock.

Warning

Unattended children or animals in the vehicle can cause the vehicle to move and endanger themselves and traffic, for example, due to the following actions:



- Establishing standby.
- Releasing the parking brake.
- Opening and closing the doors or windows.
- Engaging selector lever position N.
- Using vehicle equipment.

There is a risk of accident, injury, and property damage. Do not leave children or animals unattended in the vehicle. Take the vehicle key with you when exiting and lock the vehicle.

Establishing the sleep mode automatically

The sleep mode is established automatically such as in the following situations:

- After several minutes, if no operation takes place on the vehicle.
- If the charge state of the vehicle battery is low.
- Depending on settings configured via Interaction Unit: One or both front doors will open when exiting the vehicle after a drive.

In some situations, the idle state is not set automatically, for instance during a phone call or when the low-beam headlights are switched on.

Establishing idle state when opening the front doors

After a trip, the sleep mode can be established by opening the front doors. For this purpose, all passengers must exit the vehicle.

To activate/deactivate this function, go through the menu as follows: Apps menu / "Vehicle" / "Doors and windows" / "Lock/unlock" / "Turn off after opening door".

Establishing the sleep mode manually



To turn on sleep mode manually, push and hold the volume button on the switch cluster until all displays go out.

Standby state

Principle

When standby state is switched on, most functions can be used while the vehicle is stationary. Desired settings can be adjusted. The vehicle is in the standby state after the front doors are opened from the outside.

General information

To preserve the vehicle battery, use standby and the activated power consumers only as long as absolutely necessary.

Manually setting to standby

General information

Standby can be switched back on after the vehicle is automatically set to idle state.

Using the Start/Stop switch



Turn the Start/Stop button on the switch cluster. The Interaction Unit illuminates.

Interaction Unit view



OFF is displayed on the Interaction Unit. The drivetrain is switched off and standby state switched on.

Drive-ready state

General information



Drive-ready state is turned on/off using the Start/Stop button.

Activated drive-ready state is the equivalent of a running engine in conventional vehicles.

Deactivated drive-ready state is equivalent to switching the engine off.

When the drive-ready state is switched on, the vehicle is operational. READY appears on the Interaction Unit.

All vehicle systems are ready for operation.

To preserve the vehicle battery, switch off drive-ready state and any unnecessary power consumers when parked.

Safety information

Warning

When driving in electric mode, pedestrians and other road users might pay less attention to the vehicle due to the lack of engine noise. There is a risk of accident, injury, and property damage. Adjust driving style to traffic conditions. Watch surrounding traffic closely and actively intervene where appropriate

Warning

An unsecured vehicle can begin to move and possibly roll away. There is a risk of accident, injury, and property damage. Before leaving the vehicle, secure the vehicle against rolling away.

In order to ensure that the vehicle is secured against rolling away, follow the following:

- Set the parking brake.
- Automatic transmission: Make sure that selector lever position P is engaged.
- On uphill grades or on downhill slopes, turn the front wheels in the direction of the curb.
- On uphill grades or on downhill slopes, also secure the vehicle, for instance with a wheel chock.

Warning

Unattended children or animals in the vehicle can cause the vehicle to move and endanger themselves and traffic, for example, due to the following actions:

- Establishing standby.
- Releasing the parking brake.
- Opening and closing the doors or windows.
- Engaging selector lever position N.
- Using vehicle equipment.

There is a risk of accident, injury, and property damage. Do not leave children or animals unattended in the vehicle. Take the vehicle key with you when exiting and lock the vehicle.

NOTICE

Selector lever position P is automatically engaged when standby state is switched off. The wheels are blocked. There is a risk of property damage. Do not switch off standby if the vehicle is meant to coast, e.g., in a car wash.



Turning on the drive-ready state

1. Close the driver's door.
2. Depress the brake pedal.
3.  Turn the Start/Stop button on the switch cluster.

Most indicator lights and warning lights on the Interaction Unit illuminate for different lengths of time.

READY is displayed on the Interaction Unit and a signal tone sounds.

Drive-ready state is switched on.

Interaction Unit view



When drive-ready state is turned on, READY appears on the Interaction Unit.

Turning off drive-ready state

After stopping the vehicle:

1. Apply the brake and engage selector lever position P.
2. Engage the parking brake.
3. Turn the Start/Stop switch on the center console.

The READY indicator goes out and a signal tone sounds.

The drive-ready state is switched off automatically if the driver's seat belt is not buckled when the driver's door is opened.

Display and operating concept

Vehicle features and options

This chapter describes model-specific equipment, systems, and functions that are currently available, or may become available in the future, even if they are not present in the vehicle.

Additional information:

Vehicle equipment, refer to page 8.

MINI Interaction Unit

Principle

The Interaction Unit consists of a central round display with functions that can be operated by touch.

Depending on vehicle equipment, functions can also be operated via the MINI Intelligent Personal Assistant or the operating elements in the vehicle.

The Interaction Unit turns on automatically when it is needed to operate a certain function or when the vehicle is unlocked.

The Interaction Unit's main menu is divided into different areas, e.g., menu bar, status information, and widgets.

Various settings can be configured, e.g., the brightness of the Interaction Unit.

Safety information

Warning

Operating the integrated information systems and communication devices while driving can distract from surrounding traffic. It is possible to lose control of the vehicle. There is a risk of accident, injury,

and property damage. Only use the systems or devices when the traffic situation allows. As warranted, stop and use the systems and devices while the vehicle is stationary.

Warning

When driving, loose items or devices connected to the vehicle with a cable, i.e., mobile phones, may be thrown around the vehicle, e.g., in the event of an accident or when braking or performing evasive maneuvers. There is a risk of injury and risk of property damage. Secure loose objects or devices that are connected to the vehicle via a cable.

Warning

Objects in the area in front of a display can slip and damage the display. There is a risk of injury and risk of property damage. Do not place objects in the area in front of a display.

Overview

Position in the vehicle

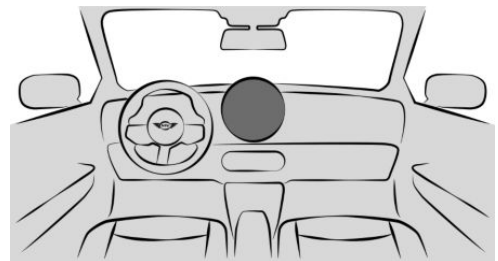

The Interaction Unit is located on the instrument panel above the center console.

Display

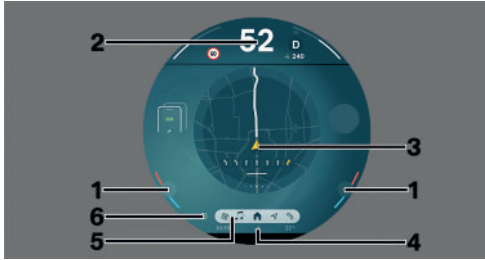

- 1 Temperature setting
- 2 Driving information 54
- 3 Widgets
- 4 Status information
Quick access
- 5 Menu bar
- 6 Saved messages
Check Control messages 144

Turning the Interaction Unit on/off

The Interaction Unit turns on automatically when the vehicle is unlocked or when it is needed to operate another function.

The Interaction Unit turns off automatically in certain situations, e.g., if the vehicle is not operated for several minutes.

Menu bar

Main menu

🏠 The main menu can be opened from any menu.

Climate menu

🌡️ The Climate menu provides access to all climate control functions.

Media menu

🎵 The Media menu provides entertainment system functions, e.g., radio stations, and can also be used to pair external devices. This icon indicates the active media source.

Apps menu

🗨️ The Apps menu provides access to all apps and vehicle functions. You can use a filter to make it easier to find a specific app. The last selected filter is stored. To display the desired app, change the filter as necessary.

Navigation menu

📍 The Navigation menu provides navigation system functions, e.g., route guidance and traffic information.

If route guidance is activated, the estimated arrival time is displayed on the menu bar.

Apple CarPlay®

📱 The Apple CarPlay menu is displayed in the main menu depending on national-market version and connected function. Apple CarPlay makes it possible to securely use select functions of a compatible Apple iPhone via the Interaction Unit.

Android Auto®

📱 The Android Auto menu is displayed in the main menu, depending on national-market version and associated function. Android Auto makes it possible to securely use select functions of a compatible Android smartphone via the Interaction Unit.

Communication menu

📞 The Communication menu provides calling and messaging functions and can also be used to pair and manage mobile devices, e.g., smartphones.

Widgets





Widgets show real-time information and dynamic content such as the navigation map. Widgets also serve as buttons and allow you to jump to the respective menu or most important functions.

Status information



General information

Status information is displayed in the form of icons on the bottom middle edge of the Interaction Unit. Depending on the equipment and national-market version, different icons are available.



Telephone status information

Icon	Meaning
	Active call.
	Microphone turned on.
	Microphone turned off.
	SIM card missing.
	Wireless charging active.

Entertainment status information

Icon	Meaning
	Bluetooth audio.
	Time shift.
	Satellite radio is switched on.





Status information messages

Icon	Meaning
	Notifications.
	Check Control message.
	Do not disturb.

Additional information:

Owner's Manual for Navigation, Entertainment, and Communication, refer to page 6.

Other status information

Icon	Meaning
	Sound output deactivated.
	Activation word active.
	MINI ID or driver profile.
	Go to quick access.

Quick access

Certain functions and individual shortcuts can be opened via quick access.





Function	Operation
Show quick link.	On the Interaction Unit, swipe from bottom to top. — Tap the icon on the status bar.
Hide quick link.	On the Interaction Unit, swipe from top to bottom.

Input and display

Entering letters and numbers

Letters and numbers can be selected when inputting destinations, for example.

Letters and numbers can be entered using the Interaction Unit or spoken commands.

Icon	Function
 	Change between capital and lower-case letters.
	Enter a blank space.
	Switching between languages.
	Use voice control.



Icon	Function
OK	Confirm entry.
◀ ▶	Shift the input area to the left or right.
←	Tap icon: delete a letter or a number.
←	Press and hold the icon: delete all letters or numbers.

Entry comparison

When entering data from a database such as contacts, the selection is gradually narrowed down for each character entered, with characters being added as necessary.

Activating/deactivating the functions

Some menu items are preceded by an icon. Selecting the menu item enables or disables the function.

Icon	Meaning
<input checked="" type="checkbox"/> 	Function is activated.
<input type="checkbox"/> 	Function is deactivated.
	Functions can be activated or deactivated using the button on the Interaction Unit. If the button is highlighted in color, the function is activated.

Shortcuts

Principle

Shortcuts provide quick access to functions such as those that are frequently used. Shortcuts can be created as necessary.

Go to the shortcuts as follows:

-  Using the buttons on the steering wheel.
- Via quick access on the Interaction Unit.

The following functions, for example, are defined as shortcuts:

- Radio stations.
- Navigation destinations.
- Phone numbers.
- Jumps to menus.

Saving shortcuts

Shortcuts can only be created with an active MINI ID or driver profile.

1. Press and hold the desired function.
2. "Add to shortcuts"

Shortcuts can also be saved directly via quick access.

Selecting shortcuts

1. To select a shortcut, swipe up from the middle of the Interaction Unit, from bottom to top.
2. Select the desired shortcut.

The function will work immediately. This means for instance that the connection is established when a phone number is selected.

Sorting shortcuts

1. To select a shortcut, swipe up from the middle of the Interaction Unit, from bottom to top.
2. Press and hold the desired shortcut and move it to the desired position.

Deleting shortcuts

1. To select a shortcut, swipe up from the middle of the Interaction Unit, from bottom to top.
2. Tap the three dots for the desired shortcut.
3.  Tap the icon for deleting the desired shortcut.

Operation

Adjusting widgets

The widgets can be adjusted in the main menu. The adjustments can only be performed when the vehicle is stationary.

1.  If necessary, tap the main menu icon.
2. On the Interaction Unit, swipe from right to left or from left to right.
3. Select the desired display.

Sorting apps

The order of apps can be adjusted in the Apps menu.

1. Open the Apps menu.
2. Press and hold the desired app icon and move it to the desired position.

Calling up the context menu

Depending on the menu item, a context menu with additional options can be displayed.

To bring up the Context menu, press and hold the desired menu item.

The menu consists of various areas, for instance:

- "General help": The Integrated Owner's Manual opens.
- "Add to shortcuts": The menu item is defined as a shortcut.

Using the map

The navigation map can be moved on the Interaction Unit.

Function	Operation
Move map.	Swipe in the appropriate direction.
Enlarge/shrink map.	Drag in or out with the fingers.
Display menu.	Tap once.

Using alphabetical lists

Contacts are listed in alphabetical order.

To navigate to a desired initial letter in a list of more than 30 entries, tap the letter on the letter bar and scroll up or down.

Favorites are displayed at the top of the list. Entries with numbers are displayed at the end of the list.

Setting the brightness

1. To adjust the brightness of the Interaction Unit, go through the menu as follows: Apps menu / "Vehicle" / "Displays" / "Interaction Unit" / "Brightness at night".
2. Select the desired setting.

Depending on the light conditions, the brightness control may not be clearly visible.

Enabling/disabling audible feedback

The Interaction Unit's audio confirmation can be activated or deactivated.

1. Go to the Media menu.



2. Select the settings icon.



3. "Sound"

4. "Touchscreen"
5. Select the desired setting.

System limits

When the Interaction Unit is subjected to very high temperatures, e.g., due to intense sunlight, the brightness may be reduced until the Interaction Unit switches off completely. The normal functions are restored once the temperature decreases, e.g., with shade or the air conditioning system.

Driving information

Principle

The driving information comprises various digital displays, e.g., speedometer, time, range, and temperature, as well as indicator lights and warning lights.

Safety information

Warning

If the driving information displays on the instrument cluster fail, e.g., the speedometer, do not use the vehicle. There is a risk of accident, injury, and property damage. Immediately park the vehicle in a safe manner. Turning drive-ready state off and on again may correct the malfunction, allowing you to continue driving. If the malfunction cannot be corrected, have the vehicle checked by an authorized service center or another qualified service center or repair shop.

Overview

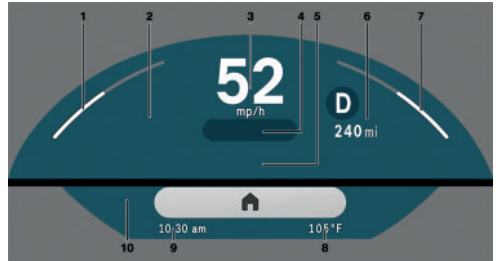

- 1 Power gauge [151](#)
Energy recovery [152](#)
Efficiency trainer [329](#)
- 2 Speed Limit Info [221](#)
Speed Limit Assistant [245](#)
Charging screen [156](#)
- 3 Operating state of vehicle [45](#)
Speedometer
Speedometer [151](#)
- 4 Driver assistance systems [221](#)
- 5 Widgets, detailed information [49](#)
- 6 Selector lever position [128](#)
Range [153](#)
Trip data [142](#)
- 7 Charge level indicator for high-voltage battery [155](#)
- 8 Outside temperature [158](#)
- 9 Time [158](#)
- 10 Check Control [144](#)

The layout is adapted to the respective drive mode.

Some views may look different than they are depicted in the Owner's Manual.

Additional information:

Indicator lights and warning lights, refer to page [145](#).

Showing detailed information

The Interaction Unit can provide additional specifics for some driving information.

Select the detailed information by tapping the desired area, e.g., tap the speedometer or Speed Limit Info display.

To show selection lists, e.g., current entertainment source, press the desired button on the right side of the steering wheel.

Additional information:

- Selection lists, refer to page 152.
- Assisted View, refer to page 157.
- Displays, trip data, refer to page 142.
- Range prediction, refer to page 154
- Speedometer, refer to page 151.

Direct access buttons



Principle

There are buttons for jumping directly to certain functions in the vehicle. These buttons can be used to bring up the respective menu directly on the Interaction Unit. Then continue operation on the Interaction Unit.

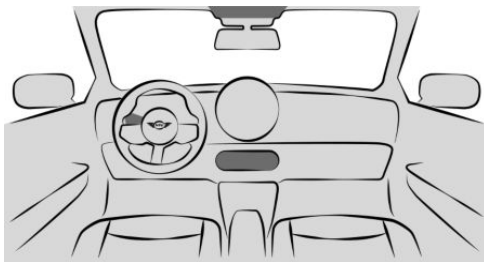
Overview



The direct jump buttons are located on the switch cluster, turn signal lever, and headliner.

Button	Function
	Go to the Drive Settings menu on the switch cluster.
	Go to the Exterior Lighting menu on the turn signal lever.
	Go to the Interior Lighting menu on the headliner.

MINI Intelligent Personal Assistant

Principle

The MINI Intelligent Personal Assistant is a personal assistant that operates various vehicle functions by means of natural spoken commands.

The Personal Assistant provides proactive suggestions to make it easier to operate the vehicle. The Personal Assistant is available depending on national-market version. The function scope and detection may vary depending on national-market version.

You can use supported voice assistants from third parties in your vehicle after pairing your smartphone.

You can configure various settings such as the suggestions from the Personal Assistant.

The system includes special microphones on the driver side and the front passenger side.

Using the voice activation system

>...<: In the Owner's Manual, commands that can be spoken are indicated by brackets.

When saying commands, note the following:



- Say the commands at a normal volume. Speaking directly into the microphone does not improve voice recognition.
- Say the commands fluently and with normal volume, emphasis, and speed.

Functional requirements

The following functional requirements apply for the Personal Assistant:

- To set a system language via the Interaction Unit, this language must be supported by the Personal Assistant.
- Download the corresponding language package before using the Personal Assistant for the first time.
- Commands must always be spoken in the selected system language.

For the full range of functions, the following functions should be activated or purchased:

- Online speech processing is enabled.
- All settings under Data privacy are enabled.
- The activation word is enabled.
- Suggestions are activated.
- A MINI ID or driver profile is activated.
- Corresponding MINI Connected Services are purchased in the MINI Connected Store.

Additional information:

- Setting the system language, refer to page 57.
- Online speech processing, refer to page 58.
- Data protection, refer to page 66.
- Activation word, refer to page 56.
- Get suggestions, refer to page 58.

Activating the voice control system

General information

You can activate voice control as follows:



- Briefly press the microphone button on the steering wheel.
- Say the activation word.

Microphone button on steering wheel



1. To activate voice control with the microphone button, briefly press the voice control button on the steering wheel.
The microphone on the driver's side is active.
2. Say the desired command.

Activation word

Principle

>Hello<: Saying the activation word starts the Personal Assistant. The microphones on the driver's or front passenger's side are active with the following voice control, depending on where the activation word was spoken.

Then say the command. The activation word and the command can be spoken without pause in one sentence.

Enabling/disabling the activation word

The activation word can be enabled and disabled.

To activate/deactivate the activation word, go through the menu as follows: Apps menu / "All" / "Personal Assistant" / "Settings" / "General" / "Activation with voice control".

Activation word from third-party providers

Depending on the national-market version, some third-party providers provide digital voice assistants such as Siri or Amazon Alexa.

To use Siri, the smartphone must be connected via Apple CarPlay.

Supported voice assistants can be used in the vehicle after you have connected your smartphone.

The activation word for voice assistants from affiliated third-party providers can be used in addition to the activation word from MINI.

1. Go through the menu as follows: Apps menu / "Vehicle" / "System settings" / "Voice control" / "Other assistants".
2. Select the desired setting.

Canceling voice control

You can cancel voice control as follows:

-  Press the microphone button on the steering wheel again.
- Say the following command: ›Cancel‹

Possible voice commands

Principle

Voice commands can be used to give instructions or ask questions, with the Personal Assistant providing assistance.

It is possible, for example, to call contacts, navigate to an address, change settings, or control vehicle functions, e.g., air conditioning, by voice command.

In addition, voice commands can be used to bring up the most important features on the Interaction Unit, e.g., menu items or lists.

Help for voice control

You can say the following commands to get help with voice control:

- ›Voice commands‹: Possible example commands are announced.
- ›General information on voice control‹: Information on how voice control operates is announced.
- ›Help‹: Tips and example commands for voice control are announced.

Sample commands

- ›Call John Smith‹
- ›Drive me to JFK airport‹
- ›Increase volume‹ or ›Decrease volume‹
- ›Activate the climate control‹
- ›What is my remaining range‹

Menu items

The Personal Assistant can open menu items directly. Say the menu items as they are shown on the Interaction Unit. You do not have to follow the order of the menu items when speaking them out loud.

1. Activate voice control.
2. ›Media‹
3. ›Presets‹
Saved stations are displayed on the Interaction Unit.

Settings

Setting the system language

You must set a system language that is supported by the Personal Assistant. A language package can be downloaded.

1. To adjust the system language, go through the menu as follows: Apps menu / "Vehicle" / "System settings" / "Language".
2. Select the desired setting.



Managing language packages

1. To manage language packages, go through the menu as follows: Apps menu / "All" / "Personal Assistant" / "Settings" / "Language".
2. Select the desired setting.

Suggestions

The Personal Assistant provides helpful, individual suggestions. Suggestions can be enabled or disabled. Suggestions can be customized, e.g., which categories suggestions are based on or whether to emit a signal tone.

1. To configure the settings, go through the menu as follows: Apps menu / "All" / "Personal Assistant" / "Settings" / "Suggestions".
2. Select the desired setting.

Online speech processing

Online speech processing improves the quality of the speech recognition and search results for points of interest. To use the functions, data is transmitted to a service provider via an encrypted connection and stored locally there. Online speech processing is not available in all languages. Online voice processing can be deactivated depending on national-market version.

To configure the settings, go through the menu as follows: Apps menu / "All" / "Personal Assistant" / "Settings" / "General" / "Online speech processing".

Configuring the visualization

How the Personal Assistant is visualized can be set.

1. To configure the visualization, go through the menu as follows: Apps

menu / "All" / "Personal Assistant" / "Settings" / "General" / "Visualization".

2. Select the desired setting.

Voice control from third-party providers

Depending on vehicle equipment, third-party voice control can be activated by pressing and holding the microphone button on the steering wheel.

1. To configure the settings, go through the menu as follows: Apps menu / "Vehicle" / "System settings" / "Voice control".
2. Select the desired setting.

Adjusting the volume

Turn the volume button during the voice guidance until the desired volume is set.

The volume remains constant even if the volume of other audio sources is changed.

Using the voice activation of the smartphone

Depending on the device, a smartphone connected to the vehicle can be used via voice control.

The device must be connected via Apple CarPlay or Android Auto.



1. Press and hold the voice control button on the steering wheel for approx. 3 seconds.

The voice activation of the smartphone is activated.

If the activation was successful, a confirmation appears on the Interaction Unit.

2.  Press the voice control button on the steering wheel to cancel the smartphone voice control.

Amazon Alexa Car Integration

Principle

Amazon Alexa Car Integration is available depending on vehicle equipment and national-market version. Alexa is a digital assistant from Amazon. With Amazon Alexa Car Integration, Alexa can be used in the vehicle. For safety reasons, the use of some Alexa functions may be restricted while driving your vehicle.

Functional requirements

- A MINI ID or driver profile is activated.
- An active Amazon account must exist.

Activating Amazon Alexa Car Integration

Amazon Alexa Car Integration is activated in the vehicle.

Follow the instructions from the Amazon Alexa app to set it up in the vehicle.

1. To activate Amazon Alexa Car Integration, go through the menu as follows: Apps menu / "All" / "Alexa".
2. Select the desired setting.

After setting it up, use Amazon Alexa in the vehicle as follows:

Say the activation word "Alexa" and the desired command.

Information about the active function is shown on the Interaction Unit.

System limits

- The Personal Assistant provides information about vehicle functions that may not be installed in the vehicle. This also applies to safety functions and systems.
- Certain noises can be detected and may lead to problems. Keep the doors and windows closed.
- Noises from the front passenger or occupants can impair the system. Avoid making other noise in the vehicle while speaking.
- Major language dialects can cause problems with the speech recognition feature.
- A poor data connection influences the response time of the Personal Assistant and the Search.

Connecting mobile devices to the vehicle

Principle

Various connection modes are available for using mobile devices in the vehicle. The connection mode to select depends on the mobile device and desired function.

General information

Detailed information on the functions and connection modes is provided in the following media from the Owner's Manual under the specified keyword:

- Integrated Owner's Manual in the vehicle.
- Printed Owner's Manual for navigation, communication and entertainment.

The following information sources can also be used:

- Driver's Guide app.
- Driver's Guide Web.

tems or devices when the traffic situation allows. As warranted, stop and use the systems and devices while the vehicle is stationary.









Safety information

Warning

Operating the integrated information systems and communication devices while driving can distract from surrounding traffic. It is possible to lose control of the vehicle. There is a risk of accident, injury, and property damage. Only use the sys-

Overview

The following overview shows possible functions and suitable connection modes for them. The functions available depend on the vehicle equipment and connected mobile device.

Function	Connection mode	Icon on Interaction Unit
Making calls via the hands-free system. Operate telephone functions via the Interaction Unit. Keyword: calling via Bluetooth.	Bluetooth. Keyword: Bluetooth connection.	
Playing music from a mobile device. Keyword: audio.	Bluetooth audio. Keyword: Bluetooth connection.	 
Calling without a mobile phone. Keyword: calling with the Personal eSIM.	Personal eSIM. Keyword: Personal eSIM.	 
Data exchange between mobile device and vehicle.	Wi-Fi. Keyword: vehicle WLAN.	
Use Internet access via the personal hotspot.	Wi-Fi via personal hotspot. Keyword: personal hotspot.	
Operate Apple CarPlay using the Interaction Unit and by voice command. Keyword: Apple CarPlay.	Bluetooth and Wi-Fi. Keyword: Bluetooth connection and vehicle Wi-Fi.	
Operate Android Auto using the Interaction Unit and by voice command. Keyword: Android Auto.	Bluetooth and Wi-Fi. Keyword: Bluetooth connection and vehicle Wi-Fi.	

MINI Remote Software Upgrade

Vehicle features and options

This chapter describes model-specific equipment, systems, and functions that are currently available, or may become available in the future, even if they are not present in the vehicle.

Additional information:

Vehicle equipment, refer to page 8.

MINI Remote Software Upgrade

Principle

Remote Software Upgrade can be used to update the entire software of the vehicle. This makes new functions, functional enhancements or quality improvements available.

General information

MINI recommends performing the Remote Software Upgrade as soon as it becomes available.

Safety information

Warning

Unattended children or animals in the vehicle can cause the vehicle to move and endanger themselves and traffic, for example, due to the following actions:

- Establishing standby.
- Releasing the parking brake.
- Opening and closing the doors or windows.

- Engaging selector lever position N.
- Using vehicle equipment.

There is a risk of accident, injury, and property damage. Do not leave children or animals unattended in the vehicle. Take the vehicle key with you when exiting and lock the vehicle.

Functional requirements

The following requirements apply for Remote Software Upgrade:

- Active MINI Connected contract.
- The integrated SIM card in the vehicle has been activated.
- The vehicle has mobile network reception.
- Consent to send corresponding data has been granted in the MINI Remote Software Upgrade settings.

Settings

To bring up the Remote Software Upgrade settings, go through the menu as follows: Apps menu / "All" / "System settings" / "Remote Software Upgrade" / "Settings".

Additional information:

Data protection, refer to page 66.

Search for an upgrade

Functional requirement

Standby must be turned on to search for a Remote Software Upgrade.

Automatic search

The vehicle checks regularly for Remote Software Upgrades in the background.



Manual search

1. To search manually for a Remote Software Upgrade, go through the menu as follows: Apps menu / "All" / "System settings" / "Remote Software Upgrade" / "Search for upgrade".
2. Follow the instructions on the Interaction Unit.

Downloading an upgrade

Automatic download

If available, the data for a Remote Software Upgrade is automatically downloaded to the vehicle. No download consent is required.

Via the MINI app

If a Remote Software Upgrade is available, information about the new software version is given in the MINI app.

The data for the upgrade can then be downloaded to a mobile device, for instance via an existing WLAN connection.

Data can then be sent from the mobile device to the vehicle.

This transmission method accelerates the download of the data, for instance in areas with limited mobile network availability.

You do not need to be present in the vehicle to download the data to a mobile device.

1. On the MINI app, download the upgrade to the smartphone.
2. Follow the instructions in the MINI app.
3. Connect your smartphone to the vehicle via Bluetooth audio and Wi-Fi.

Data for the upgrade is sent from the mobile device to the vehicle both while driving and when stopped. Depending on the size of the upgrade, it may be

necessary to drive your vehicle to complete the data transfer.

4. Follow the instructions on the Interaction Unit.

Additional information:

Connecting mobile devices to the vehicle, see Owner's Manual for Navigation, Entertainment, Communication.

Information about the version

General information

The information about the version contains a description of the updates included in the Remote Software Upgrade. Information on the version can be shown on the Interaction Unit while downloading and after the installation is complete.

This information is also provided on the MINI portal.

Displaying information

Information on the Remote Software Upgrade can be displayed on the Interaction Unit or viewed online on the MINI portal:

1. To display information in the vehicle, go through the menu as follows: Apps menu / "All" / "System settings" / "Remote Software Upgrade".
2.
 - Display currently installed version: "Installed version: "
 - Display new available version: "Version info"
3. Follow the instructions on the Interaction Unit.

To view the information on the MINI portal, visit the website:

www.mini.com/connected.

Installing the upgrade

What to know before upgrading

Before installing an upgrade, note the following:

- Installation of the Remote Software Upgrade may result in the deletion of software changes, e.g., performance increases not made by the manufacturer of the vehicle.
- The installation may be interrupted if there are modifications to the vehicle's electrical system, e.g., to control units, which were not made by the vehicle manufacturer.
- The installation does not occur until the consent was given.
- The installation may take around 20 to 30 minutes.
- The installation cannot be terminated.
- The vehicle cannot be used during the installation.
- The vehicle can be exited during the installation.
- Charging the vehicle is interrupted due to the installation.
- Following the successful installation, charging the vehicle may not continue automatically.

Prerequisites for the installation

The following requirements apply when installing Remote Software Upgrades:

- Sufficiently charged battery.
- The outside temperature is above 14 °F/-10 °C.
- The vehicle is parked in a horizontal position.
- The hazard warning system is turned off.

- The selector lever position P is engaged.
- Drive-ready state is switched off.

Where applicable, note additional requirements given on the Interaction Unit.

If the requirements are not met, e.g., sufficiently charged battery, the upgrade will not be offered for installation.

If all prerequisites are met, the upgrade can also be installed using the MINI app. Follow the instructions on the MINI app.

Look out for the offer to install the upgrade, e.g., after charging the battery for some time.

Preparing the vehicle

- Park the vehicle safely away from the public road.
- Make sure that the vehicle has mobile network reception so that a fault message can be sent to the vehicle manufacturer, e.g., if the installation is canceled.
- Close the windows.
- Close the glass sunroof.
- Close the cargo area.
- Remove devices that consume power, e.g., a mobile phone.
- Disconnect the trailer or load carrier.
- The vehicle key must be located in the vehicle for the consent for installation.
- Turn off the exterior lighting.
- Remove any devices connected to the diagnostic socket.

Install the upgrade immediately

The upgrade can be installed immediately if all prerequisites have been met.

1. Go through the menu as follows: Apps menu / "All" / "System settings" /



"Remote Software Upgrade" / "Start installation".

2. Follow the instructions on the Interaction Unit.

Installing an upgrade with the timer

Once the drive is complete, the timer can be used to automatically install the upgrade at a preset time, e.g., during the night. It may be helpful to install the upgrade at a later time so that all functional requirements can be met, e.g., to allow the vehicle battery to charge sufficiently.

1. Go through the menu as follows: Apps menu / "All" / "System settings" / "Remote Software Upgrade".
2. Select the desired settings.

The installation starts automatically when:

- All prerequisites for the installation have been established correctly.
- All prerequisites continue to be met at the time of installation.

The timer is turned off when the drive-ready state is turned on.

Installing via the MINI app

Once all preparations are done and all requirements are met, the MINI app can also be used to start the upgrade installation when the vehicle is parked. The upgrade installation can be started remotely. It is not necessary to be present in the vehicle.

It may be helpful to install the upgrade at a later time so that all functional requirements are met, e.g., to allow the engine to cool sufficiently.

Follow the instructions on the MINI app.

Functional limitations

During the upgrade, the majority of functions is temporarily unavailable, for instance:

- Hazard warning flashers.
- Central locking system and Comfort Access, as applicable.
- Parking light.
- Horn.
- Alarm system.
- Emergency call.
- Power windows.
- Glass sunroof.
- Operating the tailgate or trunk lid.
- Locking the charging socket flap.
- Exit warning if needed.

In vehicles with frameless doors, the window may no longer close completely.

The driver's door can be locked and unlocked from the outside using the integrated key.

After successful upgrade

The vehicle can be used again immediately. Purchased services, e.g., Advanced Real Time Traffic Information or Remote Services, are automatically reactivated the next time the vehicle is driven.

If the vehicle has been stationary for some time, it may be necessary to recharge the vehicle battery using the charging cable.

Malfunction

If the Remote Software Upgrade malfunctions, follow the instructions on the Interaction Unit or MINI app.

If the malfunction cannot be corrected, contact an authorized service center or another qualified service center or repair shop.

Validity of the Owner's Manual

Production of the vehicle

At the time of production at the plant, the printed Owner's Manual is the most current resource.

After a software update in the vehicle

After a vehicle software update, for example, via Remote Software Upgrade, the Integrated Owner's Manual for the vehicle will contain the latest information, depending on the national-market version.

Before setting off, make sure that the Integrated Owner's Manual is available and up-to-date.



Personal settings

Vehicle features and options

This chapter describes model-specific equipment, systems, and functions that are currently available, or may become available in the future, even if they are not present in the vehicle.

Additional information:

Vehicle equipment, refer to page 8.

Data protection

Data transfer

Principle

The vehicle offers various services that must send data to MINI or a service provider in order to be used.

The data transfer can be deactivated for some services. When data transfer is deactivated, the respective service cannot be used.

Settings

The data transfer can be configured in different stages or individually for separate services.

1. To configure the settings, go through the menu as follows: Apps menu / "All" / "Data privacy".
2. Select the desired setting.

Personal data in the vehicle

Principle

Depending on use, your vehicle stores personal data such as saved radio stations. This

personal data can be permanently deleted using the Interaction Unit.

General information

Depending on vehicle equipment, the following data is deleted, for example:

- MINI IDs or driver profiles.
- Stored radio stations.
- Stored shortcuts.
- Navigation, for instance stored destinations.
- Phone book.
- Online data, e.g., favorites, cookies.
- Office data, for instance voice memos.
- Login accounts.
- Digital key.

Altogether, the deletion of the data can take up to 15 minutes. In addition, the vehicle is removed from the MINI app and MINI Connected customer portal so that remote functions can no longer be used.

Functional requirements

The following functional requirements apply when deleting personal data in the vehicle:

- Data can only be deleted while the vehicle is stationary.
- The vehicle key must be in the vehicle.

Deleting personal data in the vehicle

The personal data in the vehicle will be deleted when the vehicle is reset to the factory settings.

Additional information:

Resetting vehicle data, refer to page 67.

Reset vehicle data

All individual settings can be reset to the factory settings when the drive-ready state is switched off. Individual settings can only be deleted while the vehicle is stationary. The vehicle key must be in the vehicle.

Go through the menu as follows: Apps menu / "Vehicle" / "System settings" / "Reset vehicle data" / "Reset".

If settings synchronization has been enabled for a MINI ID in the vehicle, personal settings are kept in the MINI Cloud.

MINI ID

Principle

In MINI Connected countries, the MINI ID is the personal login for all relevant offers from the MINI brand. The MINI ID can be used to save personal vehicle settings to a profile as well as to apply these settings.

Seven MINI IDs can be saved to the vehicle. If a vehicle is used by several people, each person can use their own MINI ID in the vehicle. Additional profiles can be used to operate the vehicle without a MINI ID, e.g., the guest profile.

The MINI ID must be registered once. A MINI ID can be registered via the MINI app, on the MINI portal, or at an authorized service center.

Automatic driver recognition can activate a MINI ID as soon as the vehicle is unlocked. To do so, a vehicle key or digital key must be linked to the MINI ID.

Many saved settings can be synchronized with the MINI Cloud. If the same MINI ID is used to log into another vehicle, these settings can be used there.

Functional requirements

The following functional requirements apply for the MINI ID:

- The vehicle must be stationary to create, change, delete, or edit a MINI ID.
- The vehicle must have mobile network reception in order to use a MINI ID to login into the vehicle and synchronize with the MINI Cloud.

Welcome window

The welcome window appears on the Interaction Unit after the vehicle is unlocked. The type of welcome depends on the following requirements:

- No MINI ID is saved to vehicle:
The welcome is neutral. These profiles are provided to use the vehicle without a MINI ID. A new MINI ID can be added.
- The vehicle key or digital key has not been assigned to a MINI ID:
The welcome is neutral. Saved profiles are shown for selection. A new MINI ID can be added.
- A MINI ID has been assigned to the vehicle key or digital key:
The welcome is personalized, the stored settings are activated. Available profiles are shown for selection. A new MINI ID can be added.

Adding a MINI ID

1.  To add a MINI ID, tap the MINI ID icon or profile image on the status bar.
2.
 - The guest profile is active:
"Guest" / "Add profile".
 - The driver profile is active:
"Log in with MINI ID".
3. Scan the displayed QR code with your smartphone.



4. Observe the instructions on your smartphone.

The MINI ID is automatically transferred to the vehicle if the MINI app is installed on the smartphone where the MINI ID is saved.

If no MINI ID is currently available, a new MINI ID can be registered.

5. Change additional settings as necessary, e.g., automatic driver recognition.

The vehicle is added to the user's MINI app. Alternatively, the authorized service center can register the MINI ID and add it to the vehicle.

Confirming a MINI ID

If the MINI ID was registered by the authorized service center and added to the vehicle, the MINI ID must be confirmed on the Interaction Unit in the respective vehicle.

1. Select the MINI ID.
2. Scan the QR code shown.
3. Follow the instructions on your smartphone.

It may be necessary to log in again with the MINI ID.

 This icon is displayed on the status bar and indicates when it is necessary to login again.

1. Select the MINI ID.
2. Scan the QR code shown.

Another login will be attempted. Once successfully logged in, all functions can be used again.

MINI app

If a MINI ID has been added to a vehicle, this vehicle is automatically added to the My MINI app. The My MINI app provides numerous beneficial functions and settings, e.g., user management.

Alternatively, an authorized service center can add a vehicle to the MINI app. In this case, the MINI ID must then be confirmed on the Interaction Unit in the corresponding vehicle.

In rare cases, the use of MINI app functions for this vehicle may be restricted. More information is given on the Interaction Unit.

Primary user

The primary user is the person who first adds their MINI ID to the vehicle and the vehicle to their MINI app. Alternatively, the primary user can be specified by an authorized service center.

The primary user has access to the following settings, for example:

- Removing the MINI ID saved to the vehicle.
- Transferring the primary user role to another MINI ID.
- Configuring vehicle-wide data protection settings.
- Creating the main digital key.

Additional information:

MINI Digital Key, refer to page [89](#).

Personalized settings

Automatic driver recognition

Principle

Automatic driver recognition can activate a MINI ID as soon as the vehicle is unlocked. To do so, a vehicle key or digital key must be assigned to the MINI ID. The MINI ID can be changed after unlocking.

If driver recognition has been configured, automatic activation of the MINI ID is triggered by the following:

- By unlocking the vehicle using the button on the assigned vehicle key.
- By unlocking the vehicle using a door handle. The assigned vehicle key or the assigned digital key must be carried with you.
- By unlocking automatically when approaching the vehicle. The assigned vehicle key or the assigned digital key must be carried with you. Depending on the country, it may not be possible to recognize the digital key.

If multiple vehicle keys or digital keys are near the vehicle, MINI IDs are activated according to the following priority:

- The key that unlocks the vehicle triggers activation of the assigned MINI ID.
- If a vehicle key and digital key are detected at the same time, the digital key triggers activation of the assigned MINI ID.
- The MINI ID of the key last detected on the driver's door is activated.

If the MINI ID could not be detected when the vehicle was unlocked, select the MINI ID on the welcome window.

Setting/adjusting automatic driver recognition

1.  To set or adjust automatic driver recognition, tap the MINI ID icon or profile image on the status bar.
2. "Profile settings"
3. "Driver recognition"
4. Select the desired setting.

Transfer of the vehicle key

A vehicle key assigned to a MINI ID can be used to view or edit personal settings.

Before a vehicle key is transferred to other persons, any assigned driver detection

should be canceled. Driver recognition can be configured in the MINI ID settings.

With MINI Digital Key, a digital key can be given to other people so that they are able to use the associated vehicle.

Additional information:

MINI Digital Key, refer to page 89.

Selecting a profile picture

The profile picture can be selected from the predefined profile pictures.

1.  To select a profile image, tap the MINI ID icon or profile image on the status bar.
2. Select the desired MINI ID.
3. "Profile settings"
4. "My MINI ID"
5. "Picture"
6. Select the desired profile picture.

The profile picture from the MINI app profile can be used for MINI IDs. To do so, synchronization with the MINI Cloud must be enabled in the settings. Once a profile picture is taken from the MINI app, the default profile images can only be used if the profile picture on the MINI app is deleted or synchronization is disabled.

Setting synchronization

Principle

If synchronization is on, settings from the following areas, for example, are synchronized:

- The MINI ID, e.g., the profile picture.
- Navigation, e.g., recent destinations, home address, or map settings.
- Media, e.g., favorites or saved radio stations.
- The Interaction Unit, e.g., the main menu configuration, language, or units.



- The Personal Assistant, e.g., suggestions or the activation word.
- Exterior lighting, e.g., one-touch signaling and pathway lighting.

Settings from the following areas are only synchronized when logging in for the first time:

- Seat and climate comfort functions, e.g., driver's seat position or temperature setting.
- Privacy menu.

Turning synchronization on/off

1.  To enable/disable settings synchronization, tap the MINI ID icon or profile image on the status bar.
2. "Profile settings"
3. "My MINI ID"
4. Select the desired setting.

The profile picture can also be set if it was not already adopted from the MINI app.

Configuring PIN protection

Once saved, MINI IDs can be selected by every user of the vehicle. Set a PIN to prevent the MINI ID's settings from being changed and the MINI ID's data from being viewed.

1.  To set a PIN, tap the MINI ID icon or profile image on the status bar.
2. Select the desired MINI ID.
3. "Profile settings"
4. "Lock screen"
5. Enter the desired PIN.

Profile management



Editing profiles

The profile can be changed at any time using the Interaction Unit:

1.  Tap the MINI ID icon or profile picture on the status bar.
2. "Change profile"
3. Select the desired MINI ID or profile.
4. If necessary, enter a PIN.

The MINI ID is activated and associated settings are loaded.

Deleting a MINI ID

1.  To delete a MINI ID, tap the MINI ID icon or profile image on the status bar.
2. "Profile settings"
3. "Manage profiles"
4.  Tap the icon to delete the desired MINI ID.

When deleting MINI IDs, note the following:

- Removing a MINI ID from the vehicle causes the vehicle to be removed from the MINI app. If the MINI ID has been synchronized with the MINI Cloud, data saved to the MINI Cloud is kept after the MINI ID is deleted. If the currently active MINI ID is removed, another profile must be selected.
- Deleting the primary user's MINI ID resets the vehicle to factory settings. The vehicle is removed from each user's MINI app, and all MINI IDs are removed from the vehicle.
- Removing a vehicle from the MINI app removes the corresponding MINI ID from the vehicle. If the MINI ID was synchronized with the MINI Cloud,

MINI ID data saved to the MINI Cloud is kept.

- If the vehicle is removed from the primary user's MINI app, it will also be removed from each user's MINI app. The corresponding MINI IDs are removed from the vehicle.

Additional profiles

Principle

Additional profiles can be used to operate the vehicle without a MINI ID.

Driver profile

"Driver": If no MINI ID is available, vehicle settings can be saved to this profile.

This profile is subject to the following restrictions, among others:

- Driver cannot be detected automatically.
- The name and profile image cannot be changed.
- There is no synchronization with the MINI Cloud.
- Certain functions are not available, e.g., navigation functions or saving favorites.

The profile, and the settings saved to it, can be transferred to a MINI ID. The MINI ID is then displayed instead of the profile.

Guest profile

"Guest": This profile can be used to operate the vehicle without changing the settings saved for other profiles.

This profile is subject to the following restrictions, among others:

- Changed settings are not saved.
- It is not possible to specify automatic driver recognition or assign a PIN.
- The name and profile image cannot be changed.

- There is no synchronization with the MINI Cloud.
- Certain functions are not available, e.g., navigation functions or saving favorites.

System limits

It may not be possible to clearly identify the driver using the vehicle key or digital key in the following situations, for example:

- The driver changes, but the vehicle is not locked and unlocked.
- If one MINI ID is assigned to multiple vehicle keys or multiple digital keys that are located outside the driver's side of the vehicle.
- If the vehicle was unlocked from the MINI app.

There are technical limitations when using personal settings for a MINI ID in other vehicles. For example, settings may be stored for a system that is not available in other vehicles, or available in a non-compatible version.

Driver profiles

Principle

Driver profiles can be used in countries where MINI Connected is not available in order to save and enable personal settings in the vehicle.

Your vehicle can save up to seven driver profiles. If a vehicle is used by several people, each person can use their own driver profile in the vehicle. The guest driver profile can be used when driving the vehicle without a driver profile.

Automatic driver recognition can activate a driver profile as soon as the vehicle is unlocked. To do so, a vehicle key must be linked to the driver profile.



Functional requirement

The vehicle must be stationary to create, change, delete, or edit a driver profile.

Welcome window

A welcome window appears on the Interaction Unit after the vehicle is unlocked. The type of the welcome depends on the following prerequisites:

- No driver profile is saved to the vehicle:
The welcome is neutral. A new driver profile can be added.
- Vehicle key has not been assigned to a driver profile:
The welcome is neutral. Saved driver profiles are shown for selection. A new driver profile can be added.
- A driver profile has been assigned to the vehicle key:
The welcome is personalized, the stored settings are activated. The available driver profiles are shown for selection. A new driver profile can be added.

Driver profile, driver

"Driver": A driver profile allows the driver to save individual vehicle settings as well as create a name for this profile and select a profile image.

Driver profile, guest

"Guest": This driver profile can be used to operate the vehicle without changing the settings saved for other driver profiles.

This profile is subject to the following restrictions, among others:

- Changed settings are not saved.
- It is not possible to specify automatic driver recognition or assign a PIN.
- The name and profile image cannot be changed.

Adding a driver profile

1.  To add a driver profile, tap the driver profile icon or profile picture on the status bar.
2. "Add profile"
3. Change additional settings as necessary, e.g., automatic driver recognition.

Personalized settings

Automatic driver recognition

Principle

Automatic driver recognition can activate a driver profile as soon as the vehicle is unlocked. To do so, a vehicle key must be assigned to the driver profile. After unlocking, you can change the driver profile.

If driver recognition has been configured, automatic activation of the driver profile is triggered by the following:

- By unlocking the vehicle using the button on the assigned vehicle key.
- By unlocking the vehicle using a door handle. You must carry your assigned vehicle key with you.
- By automatic unlocking when approaching the vehicle. You must carry your assigned vehicle key with you.

If multiple vehicle keys are near the vehicle, driver profiles are activated according to the following priority:

- The key that unlocks the vehicle triggers activation of the assigned driver profile.
- The driver profile of the key last detected at the driver's door is activated.

If the driver profile could not be detected when unlocking the vehicle, select the desired driver profile in the welcome window.

Setting/adjusting automatic driver recognition

1.  To set or adjust automatic driver recognition, tap the MINI ID icon or profile image on the status bar.
2. "Profile settings"
3. "Driver recognition"
4. Select the desired setting.

Transfer of the vehicle key

A vehicle key assigned to a driver profile can be used to view or change saved personal settings.

Before a vehicle key is transferred to other persons, any assigned driver detection should be canceled.

You can configure driver recognition in the driver profile settings.

Configuring PIN protection

Once saved, driver profiles can be selected by every user of the vehicle. If you want to prevent settings from being changed or data from being viewed for a driver profile, it is possible to set PIN protection.

1.  Tap the driver profile icon or profile picture on the status bar.
2. Select the desired driver profile.
3. "Profile settings"
4. "Lock screen"
5. Enter the desired PIN.

Profile management

Changing driver profiles



The driver profile can be changed at any time using the Interaction Unit:

1.  Tap the driver profile icon or profile picture on the status bar.
2. "Change profile"

3. Select the desired driver profile.
4. If necessary, enter a PIN.

The driver profile is activated and associated settings are loaded.

Deleting the driver profile

1.  To delete a driver profile, tap the driver profile icon or profile picture on the status bar.
2. "Profile settings"
3. "Manage profiles"
4.  Tap the icon to delete the desired driver profile.

System limits

It may not be possible to clearly identify the driver using the vehicle key in the following situations, for example:

- The driver changes, but the vehicle is not locked and unlocked.
- If multiple vehicle keys with assigned driver profiles are located on the driver's side of the vehicle.

Opening and closing

Vehicle features and options

This chapter describes model-specific equipment, systems, and functions that are currently available, or may become available in the future, even if they are not present in the vehicle.

Additional information:

Vehicle equipment, refer to page 8.

Vehicle key

Principle

Two vehicle keys are included in the scope of delivery, each containing an integrated key.

Each vehicle key contains a replaceable battery. If the vehicle key's battery is discharged, the vehicle key will not be detected. In this case, drive-ready state can be turned on by emergency detection of the vehicle key.

Depending on the equipment and national-market version, various settings are possible for the button functions.

A MINI ID or driver profile with personal settings can be assigned to a vehicle key.

To provide information on maintenance recommendations, the service data is stored in the vehicle key.

To prevent possible locking in of the vehicle key, take the vehicle key with you when exiting the vehicle.

Safety information



Warning



The vehicle key has a button cell battery. Batteries or button cell batteries can be swallowed and lead to serious or fatal injuries within two hours, for example due to internal burns or chemical burns. There is a risk of injury or danger to life. Keep the vehicle key and batteries out of reach of children. Immediately seek medical help if there is any suspicion that a battery or button cell battery has been swallowed or is located in any part of the body.

Overview



Buttons on the vehicle key.

Icon	Meaning
	Unlock.
	Lock. Stationary climate control, refer to page 291.
	Displaying the charging screen, refer to page 156.

Icon	Meaning
	Open the cargo area.
	Panic mode. Pathway lighting, refer to page 166.

Additional vehicle keys

Additional vehicle keys are available from an authorized service center or another qualified service center or repair shop.

Loss of vehicle keys

A lost vehicle key can be disabled and replaced by an authorized service center or another qualified service center or repair shop.

If a MINI ID or driver profile was assigned to the lost vehicle key, the association to this vehicle key must be deleted. A new vehicle key can then be assigned to the MINI ID or driver profile.

Replacing the battery

NOTICE

Improper batteries in a battery-operated device can damage the device. There is a risk of property damage. Always replace the discharged battery with a battery with the same voltage, the same size and the same specification.

To replace the vehicle key battery, proceed as follows:

1. Press and hold the button, arrow 1, then pull the cover, arrow 2, out of the locking mechanism from the bottom end.



2. Pull the cover out of the upper locking mechanism, arrow, then remove the cover.



3. Use a coin to open the battery compartment lid, turning the coin counterclockwise.

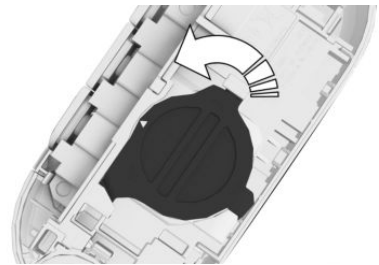

- Remove the battery from the battery housing.



- Insert a CR2032 3V battery with the positive terminal facing up.
- Use a coin to close the battery compartment lid, turning the coin clockwise, arrow 1. The lid is fully closed when the arrowheads, arrow 2, point toward each other.

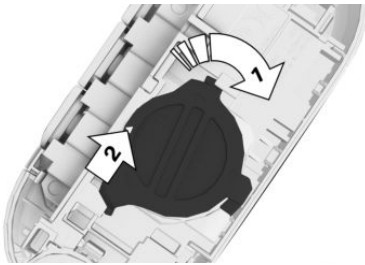

- Insert the cover in reverse order, arrow 1 and arrow 2. The cover must audibly engage at the top and bottom.

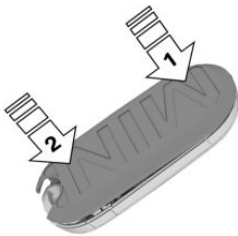

 Have old batteries disposed of by an authorized service center or an-

other qualified service center or repair shop, or take them to a collection point.



Batteries contain harmful chemicals. It is prohibited by law to dispose of batteries together with household waste.

Integrated key

Principle

The integrated key is built into the vehicle key. If the electrical system malfunctions, the vehicle can be unlocked and locked manually using the integrated key.

Depending on the national-market version, the integrated key will fit in the glove compartment.

Safety information

Warning

For some national-market versions, unlocking from the inside is only possible with particular knowledge.

If persons or animals spend a lengthy time in the vehicle and are thereby exposed to extreme temperatures, there is a risk of injury or danger to life. Do not lock the vehicle from the outside when there are people or animals in it. Do not leave babies, toddlers or animals alone in the vehicle.

Removing the integrated key

1. Press and hold the button, arrow 1, then push the cover, arrow 2, downward and remove it.

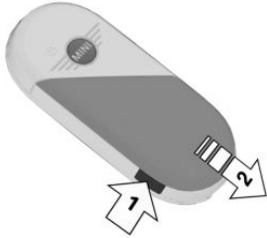

2. Push the end of the key head, arrow. The integrated key is raised slightly.
3. Remove the integrated key.

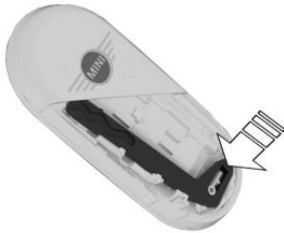

Unlocking the vehicle manually

1. Pull and hold the driver's door handle outward with one hand.

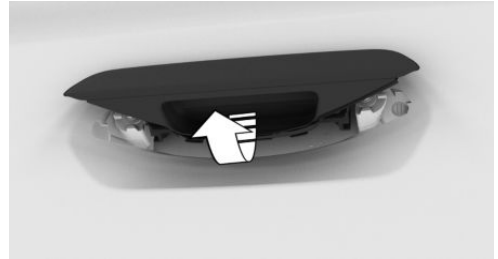

2. Unlock the door lock with the integrated key by turning it counterclockwise.

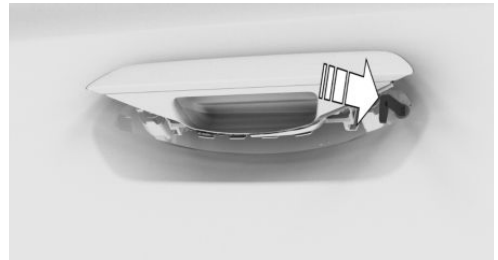

3. Pull out the vehicle key and release the door handle.
4. Open the driver's door.
5. Press the central locking button to unlock the other doors. With the vehicle de-energized: pull the door opener of the other doors from the inside.

Locking the vehicle manually

General information

To avoid locking the vehicle key in the vehicle, do not place the vehicle key in the vehicle.

Locking the vehicle

1. Close all doors.
2. Enter the vehicle on the front passenger's side and close the front passenger door.
3. Press the central locking button to unlock all doors.
4. Exit the vehicle through the front passenger door.
5. With the integrated key, close and lock the front passenger door using the side door lock.

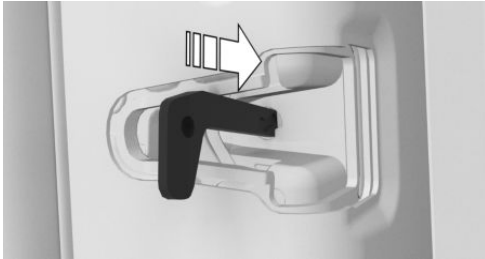

6. Pull the door handles to make sure they are locked. If necessary, repeat the process.

If vehicle is de-energized:

1. With the integrated key, close and lock all doors, except the driver's door, using the side door lock.

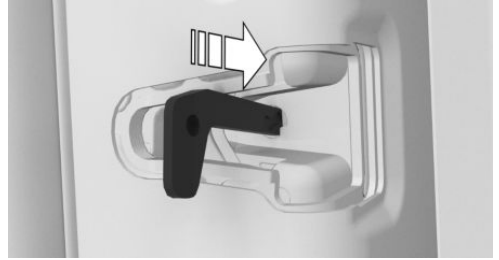

2. Pull and hold the driver's door handle outward with one hand.

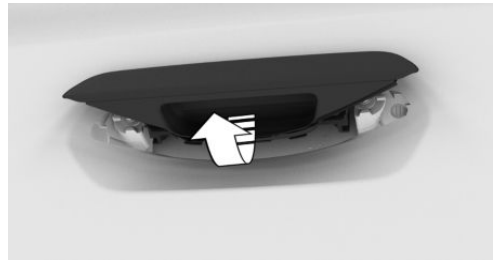

3. Using the integrated key, lock the driver's door lock clockwise.



4. Pull out the vehicle key and release the door handle.
5. Close the driver's door.
6. Pull the door handles to make sure they are locked. If necessary, repeat the process.

Alarm system

If the vehicle is unlocked with the integrated key via the door lock, the activated alarm system will be triggered when the door is opened.

In this case, use the vehicle key emergency detection to switch off the alarm.

If the doors are manually locked from the inside, the alarm system is not activated.

Emergency detection of the vehicle key

Principle

If the vehicle key's battery is discharged, the vehicle key will not be detected. In this case, drive-ready state can be turned on by emergency detection of the vehicle key.

Turning on the drive-ready state

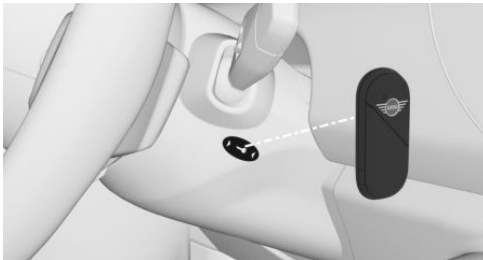

1. To turn on drive-ready state via emergency detection of the vehicle key, hold the back of the vehicle key to the marking on the steering column. Pay attention to the view shown on the Interaction Unit.
2.
 - If the vehicle key is detected:
Turn on drive-ready state within 10 seconds.
 - If the vehicle key is not detected:
Slightly change the position of the vehicle key and repeat the procedure.

Malfunction

A Check Control message is displayed where applicable.

Vehicle key detection by the vehicle may malfunction under the following circumstances:

- The battery of the vehicle key is discharged.
- Fault of the radio link from transmission towers or other equipment with high transmitting power.
- Shielding of the vehicle key due to metal objects.

Do not transport the vehicle key together with metal objects.

- Fault of the radio link from mobile phones or other electronic devices in direct proximity to the vehicle key.

Do not carry the vehicle key in close proximity to other electronic devices.

- Fault of radio transmission by a charging process of mobile devices, for instance charging of a mobile phone.
- The vehicle key is located in direct proximity of the wireless charging tray.
Place the vehicle key in a different location.
- Fault of the radio link while charging the vehicle.

In the case of interference, the vehicle can also be unlocked and locked from the outside with the integrated key. Use the Emergency detection of the vehicle key to turn on drive-ready state.

Access to vehicle interior

Principle

The vehicle can be unlocked/locked as follows:



- With the vehicle key.
- Using the door handle.
- With the Key Card.
- With the MINI Digital Key.
- Hands-free unlocking/locking

Safety information

Warning

People or animals in the vehicle can lock the doors from the inside and lock themselves in. In this case, the vehicle cannot be opened from the outside. There is a risk of injury. Take the vehicle key with you so that the vehicle can be opened from the outside.

Warning

For some national-market versions, unlocking from the inside is only possible with particular knowledge.

If persons or animals spend a lengthy time in the vehicle and are thereby exposed to extreme temperatures, there is a risk of injury or danger to life. Do not lock the vehicle from the outside when there are people or animals in it. Do not leave babies, toddlers or animals alone in the vehicle.

Warning

Unattended children or animals in the vehicle can cause the vehicle to move and endanger themselves and traffic, for example, due to the following actions:

- Establishing standby.
- Releasing the parking brake.
- Opening and closing the doors or windows.

- Engaging selector lever position N.
- Using vehicle equipment.

There is a risk of accident, injury, and property damage. Do not leave children or animals unattended in the vehicle. Take the vehicle key with you when exiting and lock the vehicle.

Actions during unlocking

Depending on the settings, the following functions are performed when unlocking the vehicle:

- Only the driver's door and the charging socket flap will be unlocked or all access to the vehicle will be unlocked.
- The unlocking of the vehicle can be confirmed with a light signal or a sound signal.
- The welcome light can be turned on when the vehicle is being unlocked.

In addition, the following functions are executed:

- If a MINI ID or driver profile was assigned to the vehicle key, this MINI ID or driver profile will be enabled.
- The interior lights are switched on, unless they were manually switched off.
- Depending on vehicle equipment, folded-in exterior mirrors are folded out.

If the exterior mirrors were folded in using the button inside the vehicle, they will not fold out when the vehicle is unlocked.

- Anti-theft protection is switched off.
- The alarm system is switched off.

Additional information:

- Settings, refer to page 93.
- Welcome lights, refer to page 165.
- MINI ID, refer to page 67.
- Driver profiles, refer to page 71.

Actions during locking

Depending on the settings, the following functions are performed when locking the vehicle:

- The locking of the vehicle can be confirmed with a light signal or a sound signal.
- Depending on vehicle equipment, the exterior mirrors can be folded in automatically when locking. The exterior mirrors are not folded in when the hazard warning flashers are switched on.

The following functions are executed:

- All doors, the trunk, and the charging socket flap are locked.
- Anti-theft protection is switched on. This prevents the doors from being unlocked using the lock buttons or the door openers.
- The alarm system is switched on.

If the drive-ready state is still turned on when you lock the vehicle, the vehicle horn will honk twice. In this case, drive-ready state must be turned off using the Start/Stop switch.

Additional information:

Settings, refer to page [93](#).

With the vehicle key

Unlocking the vehicle



To unlock the vehicle using the vehicle key, press the unlock button on the vehicle key.

If only the driver's door and charging socket flap have been unlocked due to the settings, press the button on the vehicle key again to unlock the other vehicle access points.

After opening one of the front doors, the vehicle is ready for operation.

The lighting functions may depend on the ambient brightness.

Locking the vehicle

1. To lock the vehicle using the vehicle key, close the driver's door.
2.  Press the lock button on the vehicle key.

On the door handle

Principle

The vehicle can be accessed without using the vehicle key.

The vehicle key is automatically detected near the vehicle.

General information

Function availability depends on vehicle equipment.

Depending on national-market version, the vehicle can also be unlocked and locked via the door handle using a compatible smartphone and digital key.

Additional information:

MINI Digital Key, refer to page [89](#).

Functional requirements

To get inside the vehicle using the door handle, the following functional requirements must be met:

- Carry the vehicle key with you, e.g., in your pants pocket.
- Bluetooth must be activated on the smartphone to unlock and lock using the digital key.
- To lock the vehicle, the vehicle key must be outside of the vehicle near the doors.
- After locking, approx. 2 seconds must elapse before unlocking is possible.



Unlocking the vehicle using the door handle

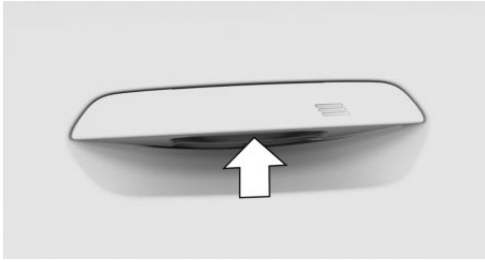

To unlock the vehicle using the door handle, reach into the recessed grip on one of the front doors.

Locking the vehicle with the door handle

1. To lock the vehicle using the door handle, close the driver's door.
2. If carrying the vehicle key on your person, place a finger on the grooved surface of a closed door's handle for approx. 1 second without reaching into the recessed grip.

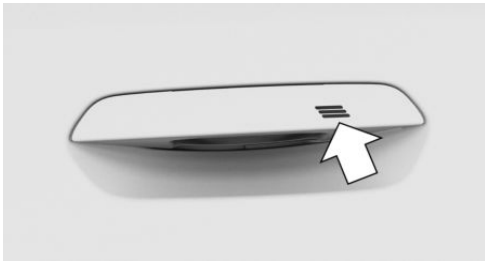

Malfunction

Wet or snowy conditions may disrupt the locking request detection on the door handles.

In the case of a malfunction, unlock and lock the vehicle using the buttons of the vehicle key or use the integrated key.

Touchless unlocking/locking of the vehicle

Principle

The vehicle will be unlocked when an authorized vehicle key is detected in the unlocking zone.

The unlocking zone is located within a radius of approx. 5 ft/1.50 m around the side and rear of the vehicle.

The vehicle will be locked when the vehicle key leaves the locking zone.

The locking zone is located within a radius of approx. 9 ft/3 m around the side and rear of the vehicle.

Automatic unlocking and locking must be activated in the settings.

General information

The function is available with Comfort Access.

Depending on the national-market version, touchless unlocking and locking is also possible for compatible smartphones with a digital key. Enable Bluetooth on your smartphone to do so.

If the vehicle key is located in the unlocking zone for an extended period of time without movement, the vehicle will be locked automatically.

If someone is detected on a seat while locking the vehicle, the following restrictions apply:

- The vehicle will be locked but not secured against theft.
- The charging socket flap remains unlocked.

Additional information:

MINI Digital Key, refer to page [89](#).



Actions during unlocking

If the settings specify that only the driver's door and the charging socket flap will be unlocked, note the following:

The driver's door and the charging socket flap will only be unlocked when the driver approaches the vehicle on the driver's side.

Additional information:

Settings, refer to page [93](#).

Functional requirements

To unlock/lock the vehicle hands-free, the following functional requirements must be met:

- Carry the vehicle key with you, e.g., in your pants pocket.
- Bluetooth must be activated on the smartphone for contactless unlocking and locking using the digital key.
- Automatic unlocking and locking must be activated in the settings.
- The drive-ready state must be turned off.
- If the vehicle has been in the idle state for several days, contactless unlocking/locking will only be available after the vehicle has been driven.

Additional information:

Settings, refer to page [93](#).

With the Key Card

Principle

The Key Card is a chip card on which the digital key is installed. The Key Card can be used to unlock and lock the vehicle.

Additional information:

Key Card, refer to page [88](#).

General information

The Key Card is available with Comfort Access.

Unlocking/locking the vehicle with the Key Card

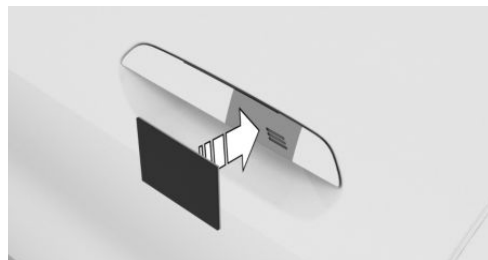

To unlock/lock the vehicle using the Key Card, hold the activated Key Card directly over the middle of the driver's door handle.

When locking the vehicle with the Key Card, make sure that all doors and the trunk are closed.

If the Key Card is not detected, slightly change the position of the Key Card and repeat the procedure.

With MINI Digital Key

Principle

Depending on vehicle equipment and national-market version, a digital key can be installed on a compatible smartphone and used to unlock and lock the vehicle.

Additional information:

MINI Digital Key, refer to page [89](#).



Unlocking/locking the vehicle with the MINI Digital Key

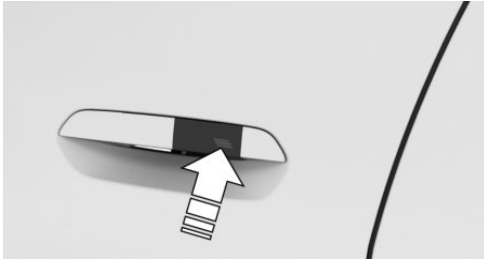

To unlock/lock the vehicle with the MINI Digital Key, hold the smartphone's NFC antenna directly over the middle of the driver's door handle. The position of the near field communication antenna depends on the smartphone model.

When locking the vehicle with the smartphone, make sure that all doors and the trunk are closed.

Frequently Asked Questions

What precautions can be taken to be able to open a vehicle, despite accidentally locking in the vehicle key?

- The MINI app's Remote Services include options for locking/unlocking a vehicle, among others.

This requires an active MINI Connected contract and the MINI app must be installed on a smartphone.

- Unlocking the vehicle can be requested via the MINI Connected Call Center.

An active MINI Connected contract is required.

Access to the cargo area

Principle

The trunk can be opened/closed as follows:

- With the vehicle key.
- In the trunk.
- Inside the vehicle.
- Hands-free opening/closing.

General information

The cargo area will be opened to the configured opening height.

Safety information

Warning

Body parts can be jammed when operating the tailgate. There is a risk of injury. Make sure that the travel path of the tailgate is clear during opening and closing.

Warning

The tailgate swings back and up when it opens. There is a risk of injury and risk of property damage. Make sure that the travel path of the tailgate is clear during opening and closing.

Warning

Sharp-edged or pointed objects can hit the windows and heating elements while driving. There is a risk of injury or risk of property damage. Cover the edges and ensure that pointed objects do not hit the windows.

With the vehicle key

General information

To avoid locking the vehicle key in the vehicle, do not place the vehicle key in the cargo area.



Depending on vehicle equipment and national-market version, the following settings can be changed:

- Unlocking the cargo area with the vehicle key also unlocks the doors.
- Before unlocking the cargo area with the vehicle key, first unlock the vehicle.

Functional requirements

To access the cargo area using the vehicle key, the following functional requirements must be met:

- To open the cargo area with the vehicle key, the trailer power socket must not be occupied.
- Selector lever position P must be engaged to open the cargo area with the vehicle key.
- You must enable the setting for opening with the vehicle key.

Additional information:

Settings, refer to page 93.

Opening the trunk



On the vehicle key, press and hold the trunk button for approx. 1 second.

On the cargo area

General information

Depending on vehicle equipment, the cargo area can be accessed without operating the vehicle key.

The key is automatically detected near the vehicle.

Depending on the national-market version, compatible smartphones with a digital key are also detected automatically. In this case, the cargo area can be opened with a smartphone.

Additional information:

MINI Digital Key, refer to page 89.

Functional requirements

To access the cargo area using the cargo area, the following functional requirements must be met:

- Carry the vehicle key with you, e.g., in your pants pocket.
- Bluetooth must be activated on the smartphone to detect the digital key.

Opening the cargo area

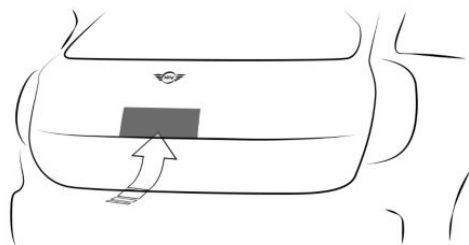

The trunk can be opened as follows:

- Unlock the vehicle, then press the button on the trunk.
- With Comfort Access: Carry the vehicle key with you and press the button on the trunk.

Locked doors are not unlocked.



Swivel the tailgate upward.

Closing the cargo area

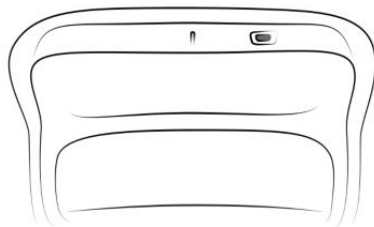
The trunk can be closed as follows:





-  On the tailgate, press the button for opening/closing.
-  On the tailgate, press the lock button.
The vehicle is locked after closing the cargo area. To do so, the driver's door must be closed and the vehicle key must be outside of the vehicle near the cargo area.
- Pull the tailgate down slightly. The tailgate closes automatically.

In the interior

Functional requirements

To open the cargo area using the button inside, the trailer power socket must not be occupied.

The vehicle key or digital key must be located inside the vehicle in order to close the cargo area using the button in the vehicle interior.

When the vehicle is locked, selector lever position P must be engaged before the tailgate can be opened using the button in the vehicle interior.

Opening the trunk

 In the storage compartment on the driver's door, press the button for opening/closing the trunk.

Closing the cargo area

 Pull and hold the button for opening/closing the cargo area on the driver's door.

An acoustic signal sounds before the cargo area is closed.

Interruption of the opening procedure

The opening process stops in the following situations:

- When the vehicle starts moving.
- By pressing the button on the outside of the cargo area. Pressing it again closes the cargo area again.
- By pressing the button on the inside of the cargo area. Pressing it again closes the cargo area again.
- By pressing the button on the vehicle key.
Pressing the button again continues the opening process.
- By pressing or pulling the button in the storage compartment of the driver's door. Pressing again continues the opening procedure.

Interruption of the closing procedure

The closing process stops in the following situations:

- If the vehicle drives off with a jerky movement.
- By pressing the button on the outside of the cargo area. Pressing it again opens the cargo area again.
- By pressing the button on the inside of the cargo area. Pressing it again opens the cargo area again.
- By pressing the button on the vehicle key. Pressing it again opens the cargo area again.
- By releasing the button in the storage compartment of the driver's door. Pulling again and holding continues the closing motion.



Touchless opening and closing of the cargo area

Principle

Touchless opening and closing of the cargo area is possible when carrying the vehicle key on your person.

Sensors detect specific foot movements near the center of the rear area, and the cargo area opens or closes.

General information

Function availability depends on vehicle equipment and national-market version.

If the vehicle key is within the sensor range, the cargo area may open or close inadvertently if you unintentionally move your foot or if a foot movement is detected.

The sensor has an approximate range of 5 ft/1.50 m extending from the rear area.

If contactless opening is used for the cargo area, the locked doors will not be unlocked.

Depending on national-market version, contactless opening of the cargo area is also possible for compatible smartphones with a digital key.

Additional information:

MINI Digital Key, refer to page 89.

Functional requirements

To open/close the cargo area hands-free, the following functional requirements must be met:

- To close the cargo area contactlessly, the automatic tailgate must be installed.
- Selector lever position P must be engaged.
- Contactless opening and closing of the cargo area must be activated in the settings.

- Bluetooth must be activated on the smartphone to open and close the cargo area contactlessly using the digital key.
- The trailer power socket must be unoccupied.
- Trailer hitches cannot be installed, depending on vehicle equipment.

Additional information:

Settings, refer to page 93.

Hands-free opening of the cargo area

1. To open the cargo area hands-free, walk behind the vehicle with the vehicle key, holding it in the middle at the rear of the vehicle, approximately one arm's length away.
2. Move one foot in the direction of travel under the vehicle and pull it back immediately or use one foot to swipe in one direction under the vehicle. During these movements, the leg must pass through the range of the sensor.



Before the cargo area opens, the hazard warning system flashes.

Moving a foot again will stop the opening procedure. The subsequent foot movement will close the cargo area again.

Hands-free closing of the cargo area

To close the cargo area hands-free, move your foot, while carrying the vehicle key on you, in the same way as for opening the cargo area.



The hazard warning system flashes and an acoustic signal sounds.

Moving a foot again will stop the closing process. The subsequent foot movement will open the cargo area again.

System limits

The detection of the foot movement may be limited due to the following external conditions:

- Ice, snow or slush on the rear of the vehicle.
- Dirt or road salt on the rear of the vehicle.
- If the sensors are dirty or covered, e.g., by stickers.
- After improper paint work on the vehicle in the area of the sensors.

Movement in range of the sensors may cause the trunk to open or close unintentionally, e.g., when objects are lifted quickly in the vehicle rear or due to the moving brushes in a car wash. To prevent such unintended opening of the cargo area in such cases, keep the vehicle key at a sufficient distance from the rear of the vehicle.

Depending on vehicle equipment: Objects mounted on a trailer hitch cannot be detected if the trailer power socket is not plugged in.

Malfunction

Warning

With manual operation of a blocked tailgate, it can release itself unexpectedly from the blocking. There is a risk of injury and risk of property damage. Do not operate the tailgate manually if it is blocked. Have the vehicle checked by an authorized service center or another qualified service center or repair shop.

In the event of an electrical malfunction in the automatic tailgate, operate the unlocked tailgate slowly with a smooth motion by hand.

To close the tailgate fully, press down lightly only. Closing occurs automatically.

Key Card

Principle

The Key Card allows the vehicle to be unlocked and locked, as well as started.

A digital key that has already been paired with the vehicle is installed on the Key Card. The digital key must be activated on the Interaction Unit.

General information

Key Card availability depends on vehicle equipment and national-market version.

Before leaving the vehicle, deactivate the Key Card or take the Key Card with you because the active Key Card can be used to start the vehicle. Always take the vehicle key with you to a service appointment.

Safety information

NOTICE

If the Key Card and a mobile device are in the wireless charging tray at the same time, the Key Card could become damaged. There is a risk of property damage. Do not place the Key Card in the wireless charging tray at the same time as a mobile device.

Activating/deactivating Key Card in the vehicle

General information

When MINI Digital Key is activated for the vehicle, a digital key can be used instead of the vehicle key.

A deactivated Key Card remains in the list of paired digital keys.

Functional requirement

A vehicle key must be located in the vehicle to activate and deactivate the Key Card.

Activating Key Card

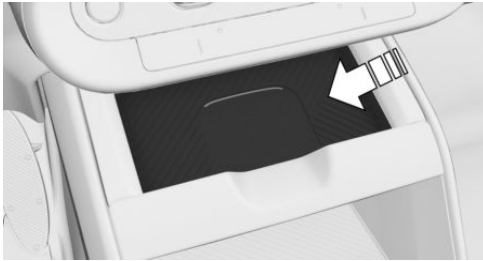

1. To activate the Key Card, place the Key Card in the center of the tray on the center console.
2. Follow the instructions on the Interaction Unit.

Deactivating Key Card

To deactivate the Key Card, go through the menu as follows: Apps menu / "Vehicle" / "Vehicle key" / "Key Card" / "Deactivate Key Card".

A deactivated Key Card remains in the list of paired digital keys.

Unlocking and locking the vehicle

The vehicle can be unlocked and locked with the activated Key Card.

Additional information:

Access to the vehicle interior, refer to page 79.

Turning on drive-ready state with the Key Card

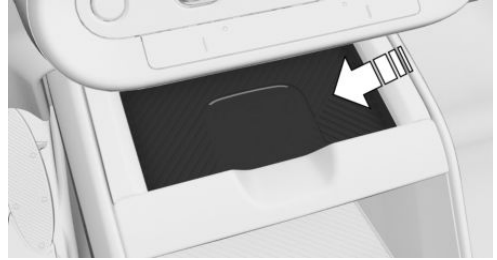

1. To turn on drive-ready state with the Key Card, place the activated Key Card in the center of the tray on the center console.
2. Turn the Start/Stop switch to activate drive-ready state.

After drive-ready state is switched on, the Key Card can be removed from the tray.

Malfunction

The vehicle may not be able to detect the Key Card if there are objects between the smartphone tray and the Key Card, e.g., a wallet or smartphone case.

MINI Digital Key

Principle

The MINI Digital Key makes it possible to unlock, lock, and start the vehicle using a digital key.

MINI Digital Key can be used with a compatible smartphone or other compatible mobile device.

To unlock and start a vehicle with a compatible smartphone, this function must be offered by the smartphone manufacturer.



The MINI app is able to check whether the smartphone and vehicle are compatible as well as determine which functions are supported.

Each vehicle can be provided with a main digital key. Additional digital keys can be shared and then deleted.

General information

MINI Digital Key availability and functionality depend on vehicle equipment and national-market version.

A MINI ID or driver profile with individual settings can be assigned to a digital key.

When using a smartphone as a digital key, it is helpful to carry the deactivated Key Card in the vehicle. In situations where the vehicle is to be given to another person, they can be given the Key Card instead of the smartphone. To do so, the Key Card must be activated via the Interaction Unit.

Always take the vehicle key with you to a service appointment.

Additional information:

- MINI ID, refer to page 67.
- Driver profiles, refer to page 71.
- Key Card, refer to page 88.

The MINI website provides additional information under the keyword “Digital Key”.

Functional requirements

The following functional requirements must be met for MINI Digital Key:

- The smartphone is compatible with MINI Digital Key
- The vehicle is linked with the vehicle owner's MINI Connected account.
- The rechargeable battery of the smartphone has a sufficient charge. The nec-

essary minimum charge of the rechargeable battery depends on the smartphone.

- Bluetooth must be activated on the smartphone for contactless unlocking and locking using the digital key.

Enabling the main digital key

Vehicle owner's smartphone is enabled as a main digital key in the vehicle. The vehicle owner must prove his authorization for the vehicle for this purpose.

Proof of authorization can be started via the MINI app or by using the activation code in the corresponding smartphone function, e.g., the Wallet app.

Both vehicle keys must be located in the vehicle to be enabled.

Follow the instructions in the Digital Key menu or on the MINI app or Interaction Unit.

Sharing digital keys

General information

The MINI Digital Key makes it possible to share digital keys with other people. This option is available via the smartphone that is enabled as main digital key. This function must be supported by the smartphone.

Forwarding authorization

To share the digital key, select the corresponding function on the smartphone, for instance in the Wallet app.

As soon as a digital key is shared with another person, the person will receive an invitation. When the invitation is accepted, the digital key on the recipient's smartphone will be activated.

Limiting the range of functions

Certain functions of the digital key can be limited before handing it over. For exam-

ple, you can disable restrictions for driving stability control systems and reduce the engine power before giving your digital key to a novice driver. For more information, refer to the MINI Connected portal and MINI app.

Authentication

Depending on the recipient's smartphone model, an authentication may be required for security and safety reasons.

An authorized vehicle key, the main digital key or another method may be used for authentication. Follow the instructions given on the smartphone or Interaction Unit.

Deleting digital keys

General information

Deleted digital keys will be removed from the list of enabled digital keys.

Deleted digital keys cannot be restored.

Deleting the main digital key

The main digital key can be deleted using the smartphone or Interaction Unit.

The deletion of the main digital key is completed immediately.

Deleting a shared key

Shared keys can be deleted using the smartphone with the main digital key, using the smartphone with a shared key, or using the Interaction Unit.

The deletion via the smartphone using the main digital key will not be performed until the vehicle is used with a key other than the key to be deleted.

Keys are deleted immediately when using the smartphone with shared key or the Interaction Unit to do so.

Deleting a digital key via the Interaction Unit

To delete a digital key using the Interaction Unit, either an authorized vehicle key must be located in the vehicle or the main digital key must be located in the smartphone tray.

1. Go through the menu as follows: Apps menu / "Vehicle" / "Vehicle key" / "Digital Key".
2. If necessary, select the digital key.
3. "Delete key"

Resetting the function

To reset the MINI Digital Key function, an authorized vehicle key must be located in the vehicle.

When resetting the MINI Digital Key, all digital keys will be deleted, including the main digital key. The Key Card's digital key is retained and deactivated.

After the reset, the vehicle can no longer be unlocked, locked or started with a digital key.

The main digital key must be enabled again to use MINI Digital Key again.

To reactivate the main digital key, go through the menu as follows: Apps menu / "Vehicle" / "Vehicle key" / "Digital Key" / "Reset function".

Unlocking and locking the vehicle

The vehicle can be unlocked and locked as follows:

- Using the door handle.
- Depending on vehicle equipment and national-market version, the vehicle can be locked and unlocked with no-touch activation.

MINI Digital Key availability and functionality depend on vehicle equipment and national-market version.



Additional information:

Access to the vehicle interior, refer to page 79.

Turning on drive-ready state with MINI Digital Key

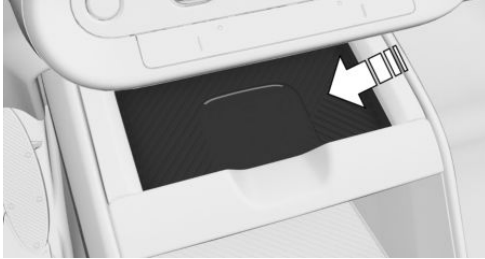

1. To turn on drive-ready state with the MINI Digital Key, place the smartphone in the center of the tray on the center console.

Ensure that the display is facing up.

2. Turn the Start/Stop switch to activate drive-ready state.

With Comfort Access, it is sufficient, depending on the country, for the smartphone with Bluetooth enabled to be located inside the vehicle. Turn the Start/Stop switch to activate drive-ready state.

Sale of the smartphone

Delete all digital keys on the smartphone prior to selling the smartphone. This ensures that the smartphone can no longer be used for the vehicle.

Changing smartphones

To use a new smartphone as a master Digital Key, activate the new smartphone according to the instructions for the master Digital Key. The previous master key is deleted when the new smartphone is activated.

Sale of the vehicle

Prior to selling a vehicle, reset the MINI Digital Key function or remove the vehicle from the current vehicle owner's MINI Connected account.

When the vehicle is removed from the MINI Connected account, all digital keys for the vehicle will be deleted. The Key Card's digital key is retained and deactivated.

System limits

With a digital key, the alarm system's interior motion sensor and tilt alarm sensor can only be deactivated using the Interaction Unit.

Additional information:

Alarm system, refer to page 95.

Malfunction

Your Digital Key may not be detected by the vehicle under the following circumstances:

- The smartphone is shielded from the sensors in the vehicle by a smartphone cover that is not suitable.
- There is an object, e.g., chip card or Key Card, between the smartphone and smartphone cover.
- The connection has been interrupted by a transmission tower or other device with a high transmitting power.
- The smartphone is shielded by a building or metallic object.

Buttons for the central locking system

Principle

The vehicle can be locked/unlocked from the inside using the buttons for the central locking system.

The vehicle is automatically locked when driving off.

In the event of a severe accident, the vehicle is automatically unlocked. The hazard warning system and interior lights are illuminated.

Overview



The central locking system buttons are located on the driver's door.



Lock the vehicle.



Unlock the vehicle.

Locking the vehicle from inside



To lock the vehicle from the inside, press the lock button on the driver's door when the doors are closed.

The vehicle is not secured against theft when locking.

Unlocking the vehicle from inside



To unlock the vehicle from the inside, press the unlock button on the driver's door.

Opening the door

When the vehicle is locked, doors can be opened as follows:

-  On the front door, press the unlock button to unlock the doors together.

Pull the door opener on the door to be opened.

- Front doors: Pull the door opener on the door to be opened. The other doors remain locked.
- Rear doors: Pull the door opener on the door to be opened twice: The first time unlocks the door, the second time opens it. The other doors remain locked.

Settings

General information

Depending on the equipment and national-market version, various settings for opening and closing are possible.

Unlocking and locking

Doors

1. Go through the menu as follows: Apps menu / "Vehicle" / "Doors and windows" / "Lock" / "Doors and windows" / "Unlock".
2. Select the desired setting:
 - "Driver's door only"

Only the driver's door and charging socket flap are unlocked. Pressing again unlocks the entire vehicle.
 - "All doors"

The entire vehicle is unlocked.

Touchless unlocking/locking

1. Go through the menu as follows: Apps menu / "Vehicle" / "Doors and windows" / "Lock" / "Doors and windows".
2. Select the desired setting:



- "Unlock when approaching"
- "Lock when walking away"

Enabling this setting also activates automatic folding of the mirrors. Automatic folding of the mirrors can be deactivated again in the corresponding menu.

Automatic unlocking

1. Go through the menu as follows:
Apps menu / "Vehicle" / "Doors and windows"/"Lock" / "Doors and windows".
2. Select the desired setting:
 - "Unlock doors at end of trip"
 - "Doors will unlock automatically when vehicle in P."

If locked, the vehicle unlocks automatically when drive-ready state is turned off or selector lever position P is engaged.

Automatic locking

Go through the menu as follows:
Apps menu / "Vehicle" / "Doors and windows"/"Lock" / "Doors and windows" / "Lock after a short time".

The vehicle locks automatically after a short period of time if no door is opened after unlocking.

Confirmation signals from the vehicle

1. Go through the menu as follows:
Apps menu / "Vehicle" / "Doors and windows"/"Lock" / "Doors and windows".
2. Select the desired setting:
 - "Flash when unlocking"
Unlocking is confirmed by two flashes.
 - "Flash when locking"
Locking is confirmed by one flash.
 - With alarm system:
"Sound on lock/unlock"

Unlocking is confirmed with two sound signals, locking is confirmed with one sound signal.

Folding mirrors in automatically

Automatic folding of the side mirrors can be adjusted on the Interaction Unit.

Go through the menu as follows: Apps menu / "Vehicle" / "Doors and windows" / "Lock" / "Doors and windows" / "Fold mirrors on lock/unlock".

Cargo area

Cargo area button on vehicle key

It is possible to choose where to assign the cargo area button on the vehicle key.

1. Go through the menu as follows:
Apps menu / "Vehicle" / "Doors and windows" / "Tailgate" / "VEHICLE KEY" / "Tailgate button".
2. Select the desired setting:
 - "Tailgate"
Depending on the equipment, the cargo area will be unlocked or opened.
 - "Tailgate and door(s)"
Depending on the equipment, the cargo area will be unlocked or opened and the doors are unlocked.
 - "Tailgate"
The vehicle must be unlocked before the cargo area can be operated with the vehicle key.
 - "Lock tailgate button"
Operating the cargo area with the vehicle key is disabled.

Adjusting the opening height

You can set how far the tailgate can be opened.

When adjusting the opening height, make sure the clearance above the tailgate is at least 4 in/10 cm.

1. Go through the menu as follows:
Apps menu / "Vehicle" / "Doors and windows" / "Tailgate" / "Opening height".
2. Monitor the tailgate and set the desired opening height.

Opening/closing the cargo area with no-touch activation

1. Go through the menu as follows:
Apps menu / "Vehicle" / "Doors and windows" / "Tailgate".
2. Select the desired setting:
 - "Open with foot movement"
 - "Close with foot movement"

Window

Opening windows automatically

1. Go through the menu as follows: Apps menu / "Vehicle" / "Doors and windows".
2. Select the desired setting.

If this setting is enabled, the driver's window opens automatically as soon as the vehicle reaches the saved location.

Alarm system

Principle

The alarm system issues a visual and acoustic signal when someone attempts to open the locked vehicle incorrectly.

General information

When the vehicle is locked, the vehicle alarm system reacts to the following changes:

- If a door, the hood, or the cargo area is opened.
- If movement is detected inside the vehicle.
- If the vehicle has a different tilt, e.g., due to an attempt to steal a wheel or when towing.
- If the battery voltage is interrupted.
- If the diagnostic socket is used improperly.
- If the vehicle is locked when a device is connected to the diagnostic socket.

The alarm system signals these changes visually and acoustically:

- Acoustic alarm:
Depending on local regulations, the acoustic alarm may be suppressed.
- Optical alarm:
By flashing of the hazard warning system and headlights, where required.

Do not modify the system to ensure function of the alarm system.

Turning the alarm system on/off

The alarm system is activated or deactivated as soon as the vehicle is locked or unlocked.

The alarm system does not turn on if the vehicle is locked manually from the inside.

Opening the doors with the alarm system switched on

The alarm system is triggered when a door is opened if the door was unlocked using the integrated key in the door lock.

Opening the cargo area with the alarm system switched on

The cargo area can be opened even when the alarm system is switched on.

After closing the cargo area, the cargo area will be locked and monitored again. The hazard warning system flashes once during closing.

Panic mode

You can trigger the alarm system if you find yourself in a dangerous situation.

-  - Press the button on the vehicle key and hold for at least 3 seconds.
- Briefly press the button on the vehicle key three times in succession.

To switch off the alarm: press any button.

Indicator light on the interior mirror

The indicator light on the interior mirror shows the status of the alarm system:



- The indicator light flashes briefly every 2 seconds:
The alarm system is switched on.
- The indicator light flashes for approx. 10 seconds, then flashes briefly every 2 seconds:
The interior motion sensor and tilt alarm sensor are not activated because the doors, hood, or tailgate are not closed correctly. Correctly closed access points are secured.

The interior motion sensor and tilt alarm sensor will turn on when all open access points are closed.

- The indicator light flashes even though all access points have been closed:
Alarm system error.
- The indicator light goes out after unlocking:
The vehicle has not been tampered with.
- The indicator light flashes after unlocking until drive-ready state is switched on, but no longer than approx. 5 minutes:
The alarm has been triggered.

Tilt alarm sensor

The tilt alarm sensor is part of the alarm system and monitors the vehicle's tilt.

The alarm system responds in situations such as attempts to steal a wheel or when the vehicle is towed.

Interior motion sensor

The interior motion sensor is part of the alarm system and monitors the vehicle interior.

The alarm system triggers when movement is detected inside the vehicle.
The windows must be closed for the system to function properly.

Avoiding unintentional alarms

General information

The tilt alarm sensor and interior motion sensor can trigger an alarm, although no unauthorized action occurred.

An unintentional alarm can be triggered in the following situations:

- In car washes.
- In duplex garages.



- During transport on trains carrying vehicles, at sea or on a trailer.
- With animals in the vehicle.

The tilt alarm sensor and the interior motion sensor can be switched off in such situations.

Switching off the tilt alarm sensor and interior motion sensor

The tilt alarm sensor and interior motion sensor can be turned off as follows:

-  As soon as the vehicle is locked, press the lock button on the vehicle key within 30 seconds.

The indicator light illuminates for approx. 2 seconds and then continues to flash.

- After standby state turns off, an option to deactivate the interior motion sensor and tilt alarm sensor appears on the Interaction Unit.

The tilt alarm sensor and interior motion sensor are deactivated until the vehicle is locked again.

Ending the alarm

To stop the alarm, unlock the vehicle.

If the vehicle is unlocked with the integrated key, the drive-ready state must subsequently be turned on via the emergency detection of the vehicle key.

Window

Principle

The windows can be operated as follows:

- With the vehicle key.
- Using the door handle.
- Using the switches inside the vehicle.

Safety information

Warning

When operating the windows, body parts and objects can be jammed. There is a risk of injury and risk of property damage. Make sure that the travel path of the windows is clear while opening and closing.

With the vehicle key

Opening windows with the vehicle key



To open the windows with the vehicle key, unlock the vehicle, then press and hold the unlock button on the vehicle key.

The windows open for as long as the button on the vehicle key is pressed.

Closing windows with the vehicle key



With Comfort Access: To close the windows with the vehicle key, lock the vehicle, then press and hold the lock button on the vehicle key.

The windows close for as long as the button on the vehicle key is pressed.

Depending on the vehicle equipment, exterior mirrors are folded in unless they were folded in while locking. The exterior mirrors are not folded in when the hazard warning flashers are switched on.

On the door handle

Principle

The windows can be closed using the door handle without operating the vehicle key.

The vehicle key is automatically detected near the vehicle.

General information

The function is available with Comfort Access.

Depending on national-market version, the windows can also be closed via the door handle using a compatible smartphone and digital key.

Additional information:

MINI Digital Key, refer to page 89.

Functional requirements

To close the windows using the door handle, the following functional requirements must be met:

- Carry the vehicle key with you, e.g., in your pants pocket.
- Bluetooth must be activated on the smartphone to close the window(s) using the digital key.

Closing windows with the door handle

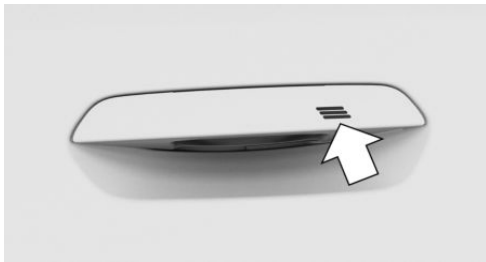

To close a window using the door handle of a closed front door, place a finger on the grooved surface of the door handle and hold it there without reaching into the recessed grip.

In addition to locking, the windows and glass sunroof with sun protection will be closed.

Depending on the vehicle equipment, exterior mirrors are folded in unless they were folded in during locking. The exterior mir-

rors are not folded in when the hazard warning flashers are switched on.

Inside the vehicle

Overview

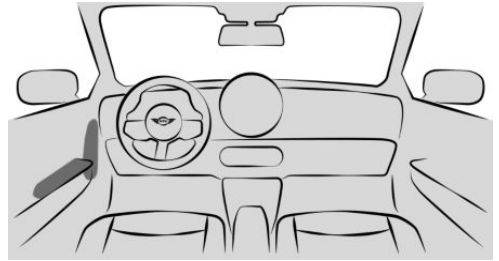

The power window switches are located on the doors.

Functional requirements

To close the windows inside the vehicle, the following functional requirements must be met:

- Standby state is switched on.
- Drive-ready state is switched on.

The vehicle key or digital key must be inside the vehicle.

Opening windows

To open the windows, proceed as follows:

-  On the door, press the power window switch to the resistance point.

The window opens while the switch is being held.

-  On the door, pull the power window switch past the resistance point.

The window opens automatically. Pressing the switch again stops the motion.

Closing the windows

To close the windows, proceed as follows:

-  On the door, pull the power window switch to the resistance point.

The window closes while the switch is being held.

-  On the door, pull the power window switch past the resistance point.

The window closes automatically. Pulling again stops the motion.

Anti-trap mechanism

Principle

The anti-trap mechanism prevents objects or body parts becoming jammed between the door frame and window while a window is being closed.

General information

If resistance or blockage is detected while a window is being closed, the closing will be interrupted.

Safety information

Warning

Accessories on the windows such as antennas can impact anti-trap mechanism. There is a risk of injury. Do not install accessories in the area of movement of the windows.

Closing without the anti-trap mechanism

In case of danger from the outside or if icing might prevent normal closing, proceed as follows:

1.  On the door, pull the power window switch past the resistance point and hold it.

The window closes with limited anti-trap mechanism. If the closing force exceeds a specific threshold, closing is interrupted.

2.  On the door, pull the power window switch past the resistance point again within approx. 4 seconds and hold it there.

The window closes without the anti-trap mechanism.

Opening windows automatically

If the driver's window is frequently opened in the same location, the window can be set to open automatically. This is useful if you frequently use the same parking garage, for example.

For the driver's window to open automatically, the vehicle speed must be below 6 mph/10 km/h and there must be sufficient GPS reception.

Additional information:

Settings, refer to page 93.

Safety switch

Principle

The safety switch can be used to prevent children, for instance, from opening and closing the rear windows using the switches in the rear.



If an accident of a certain severity occurs, the safety function is switched off automatically.

Overview

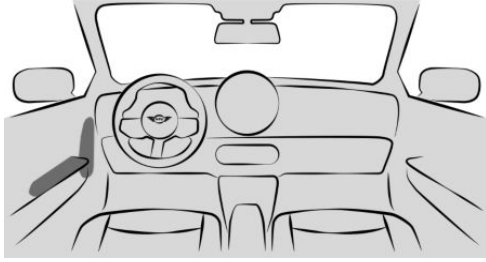

The safety switch is located on the driver's door.

Turning the safety functions on/off



To activate/deactivate the safety function, press the safety switch on the driver's door.

The LED in the button illuminates when the safety function is turned on.

Glass sunroof

Safety information

Warning

Body parts can be jammed when operating the glass sunroof. There is a risk of injury. Make sure that the area of movement of the glass sunroof is clear during opening and closing.

With the vehicle key

Opening glass sunroof



To open the glass sunroof, unlock the vehicle, then press and hold the unlock button on the vehicle key.

The glass sunroof opens for as long as the button on the vehicle key is pressed.

Closing glass sunroof



With Comfort Access: To close the glass sunroof, lock the vehicle, then press and hold the lock button on the vehicle key when close to the vehicle.

The glass sunroof closes for as long as the button on the vehicle key is pressed.

Depending on the vehicle equipment, exterior mirrors are folded in unless they were folded in while locking. The exterior mirrors are not folded in when the hazard warning flashers are switched on.

On the door handle

Principle

The glass sunroof can be closed using the door handle without operating the vehicle key.

The vehicle key is automatically detected near the vehicle.

General information

The function is available with Comfort Access.

Depending on the country, the glass sunroof can also be closed via the door handle using compatible smartphones and your digital key.

Additional information:

MINI Digital Key, refer to page [89](#).

Functional requirements

To close the glass sunroof using the door handle, the following functional requirements must be met:

- Carry the vehicle key with you, e.g., in your pants pocket.
- Bluetooth must be activated on the smartphone to close the glass sunroof using the digital key.

Closing glass sunroof

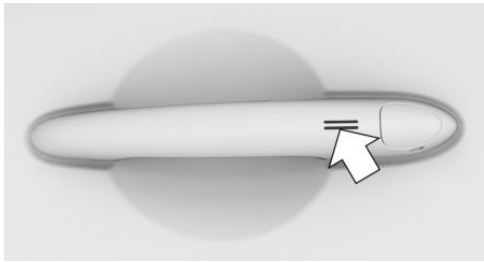

To close the glass sunroof using the driver's door handle, touch the grooved surface on the driver's door handle with your finger and hold it there without reaching into the recessed grip.

In addition to locking, the windows and glass sunroof will be closed.

Depending on the vehicle equipment, exterior mirrors are folded in unless they were folded in while locking. The exterior mirrors are not folded in when the hazard warning flashers are switched on.

Inside the vehicle

General information

The glass sunroof and the sun protection are operated using the same switch.

Overview



The glass sunroof/sun protection switch is located in the headliner.

Functional requirements

The glass sunroof can be operated when the following prerequisites are met:

- Standby state is switched on.
- Drive-ready state is switched on.

The vehicle key must be inside the vehicle.

Lifting/closing glass sunroof



To raise/close the glass sunroof, briefly press the glass sunroof switch in the headliner upward.

- The closed glass sunroof tilts.
- The opened glass sunroof closes until it is in the tilted position.
- The tilted glass sunroof closes.

Opening/closing the glass sunroof and sun protection separately

To open/close the glass sunroof and sun protection separately, proceed as follows:

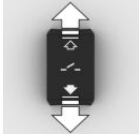

- In the headliner, push the glass sunroof/sun protection switch back to the resistance point and hold it. Holding down the switch opens the sun protection. If the sun protection is already fully open, the glass sunroof opens.

- Push the switch forward to the resistance point and hold.

The glass sunroof closes while the switch is being held. If the glass sunroof is already closed or in the tilted position, the sun protection closes.

- Push the switch back past the resistance point.

The sun protection opens automatically. If the sun protection is already fully open, the glass sunroof opens automatically.

Pressing the switch again stops the motion.

- Push the switch forward past the resistance point.

The glass sunroof closes automatically. If the glass sunroof is already closed or tilted, the sun protection closes automatically.

Pressing the switch again stops the motion.

Opening/closing the glass sunroof and sun protection together

To open/close the glass sunroof and sun protection together, proceed as follows:

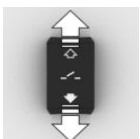

- In the headliner, push the glass sunroof/sun protection switch backward twice, in quick succession, past the resistance point.

The glass sunroof and sun protection open together.

Pressing the switch again stops the motion.

- Briefly push the switch out and forward, twice in quick succession, past the resistance point.

The glass sunroof and sun protection close together.

Pressing the switch again stops the motion.

Comfort position

On some models, there is less wind noise inside the vehicle when the glass sunroof is not fully open. In these models, the automatic function initially only opens the glass sunroof up to this comfort position.

Pressing the glass sunroof and sun protection switch in the headliner opens the glass sunroof fully.

Anti-trap mechanism

Principle

The anti-trap mechanism prevents objects or body parts from becoming jammed between the roof frame and glass sunroof while the glass sunroof is closing.

If resistance or a blockage is detected while the glass sunroof is closing, it will stop closing when the roof reaches the half-open position or when closing from the tilted position.

Closing from the open position without the anti-trap mechanism

In case of danger from the outside or icing might prevent normal closing, proceed as follows:

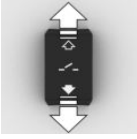

1. Close all doors.
2. Turn on drive-ready state or stop the vehicle if moving.
3. in the headliner, press the glass sunroof switch forward, past the resistance point, and hold it there.

The glass sunroof closes with limited anti-trap mechanism. If the closing force exceeds a certain threshold, closing is stopped.

4. Push the switch forward again past the resistance point and hold, until the glass sunroof closes without the anti-trap mechanism. Make sure that the closing path is clear.

Closing from the lifted position without the anti-trap mechanism

In case of danger from the outside or if icing might prevent normal closing, proceed as follows:

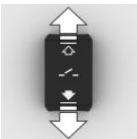

1. Close all doors.
2. Turn on drive-ready state or stop the vehicle if moving.
3. in the headliner, press the glass sunroof switch forward, past the resistance point, and hold it there.

Initializing after a power interruption

General information

After a power interruption during the opening or closing process, the glass sunroof can only be operated to a limited extent. Initializing the system can help in this case.

The system can be initialized under the following conditions:

- The vehicle is parked in a horizontal position.
- The vehicle will not be moved until the initialization is completed.
- The drive-ready state is established.
- The outside temperature is above 41 °F/5 °C.

During initialization, the glass sunroof closes without the anti-trap mechanism.

Make sure that the closing path is clear.

Initializing the system



To initialize the system, in the headliner, press the glass sunroof switch upward and hold it until initialization is complete:

Initialization begins within 15 seconds.

- If the glass sunroof is closed, it opens then closes again.
- If the glass sunroof is open, it first closes, then opens and closes again.

Initialization is complete once the glass sunroof has opened then closed again.



Seats, mirrors and steering wheel

Vehicle features and options

This chapter describes model-specific equipment, systems, and functions that are currently available, or may become available in the future, even if they are not present in the vehicle.

Additional information:

Vehicle equipment, refer to page 8.

Sitting safely

An ideal seat position that meets the needs of the occupants can make a vital contribution to relaxed, fatigue-free driving.

In the event of an accident, having the correct seat position and using the protection systems correctly both play an important role. Follow the information in the following chapters.

Additional information:

- Seats, refer to page 104.
- Seat belts, refer to page 109.
- Head restraints, refer to page 112.
- Airbags, refer to page 174.

Front seats

Safety information

Warning

Seat setting while driving can lead to unexpected movements of the seat. Vehicle control could be lost. There is a risk of accident, injury, and property damage. Only

adjust the seat on the driver's side when the vehicle is stationary.

Warning

With a backrest inclined too far to the rear, the protective effect of the seat belt can no longer be ensured. There is a risk of sliding under the seat belt in an accident. There is a risk of injury or danger to life. Adjust the seat prior to starting the trip. Adjust the backrest so that it is in the most upright position as possible and do not adjust again while driving.

Warning

There is a danger of jamming when moving the seats. There is a risk of injury and risk of property damage. Make sure that the travel path of the seat is clear prior to any adjustment.

Manually adjustable seats

Principle

Manually adjustable seats are operated using the levers on the seat.

Overview



The levers for setting the seats are located on the front seats.

Setting the longitudinal direction

Warning

If a seat is not locked, it may move unexpectedly while driving. Vehicle control could be lost. There is a risk of accident, injury, and property damage. After adjusting, move the seat forward or back slightly, making sure the seat engages properly.



To adjust the longitudinal direction, pull up the longitudinal direction lever at the front of the seat and push the seat in the desired direction.

Adjusting the height

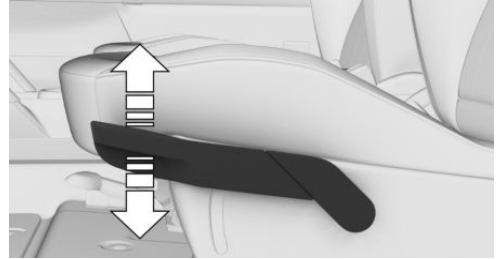

To adjust the height: On the side of the seat, push the seat height lever up or down as many times as necessary for the seat to reach the desired height.

Adjusting backrest tilt

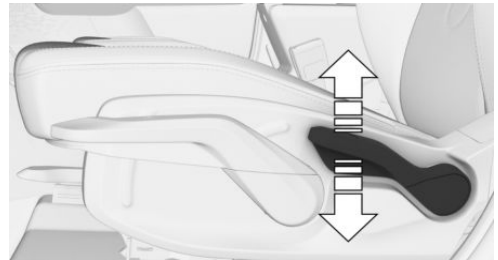

To adjust the backrest tilt, pull the backrest tilt lever on the side of the seat and tighten or loosen the backrest as required.

Electrically adjustable seats

Principle

Electrically adjustable seats are operated using the switches on the seat.

The current seat position can be stored using the memory function.

Additional information:

Memory function, refer to page [118](#).



Overview



The switches for setting the seats are located on the front seats.

Adjusting seat tilt

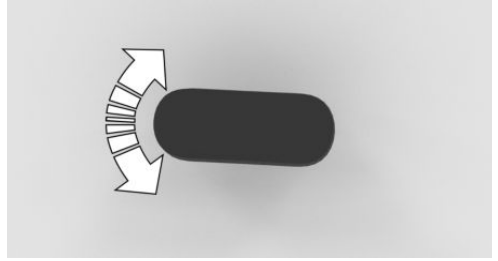

To adjust the seat tilt, flip the seat tilt switch up or down.

Setting the longitudinal direction

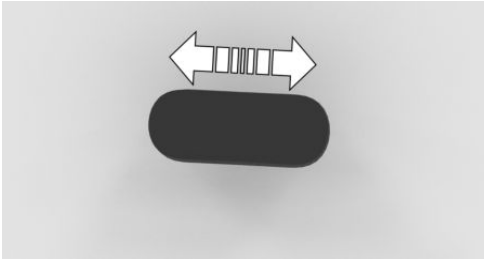

To adjust the seat in the longitudinal direction, press the longitudinal direction switch forward or backward.

Adjusting backrest tilt

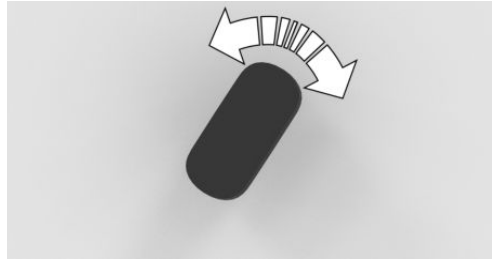

To adjust the backrest tilt, flip the backrest tilt switch forward or backward.

Adjusting the height

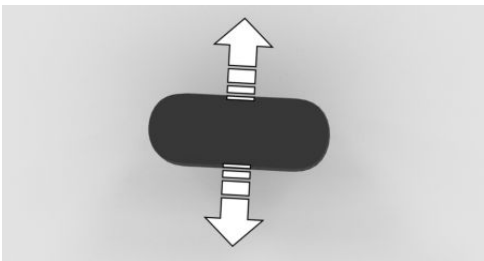

To adjust the seat height, press the seat height switch up or down.

Adjusting the seat position automatically

Principle

The seat setting for the driver's seat is saved to the active MINI ID or driver profile. If the MINI ID or driver profile is reactivated later, the saved position is applied automatically.

Activate/deactivate the function

To activate/deactivate the automatic seat adjuster, proceed as follows:

1. Go through the menu as follows: Apps menu / "Vehicle" / "Seat comfort" /

"Driver" / "Automatically use seat position".

2. Select the desired setting.

Lumbar support

Principle

The curvature of the seat backrest can be adjusted in a way that it supports the lumbar region of the spine. The lower back and the spine are supported for upright sitting position.

Adjusting the lumbar support

To adjust the lumbar support, proceed as follows:



- To increase or decrease the bulge, press the lumbar support button forward or backward.
- To move the bulge up or down, press the lumbar support button up or down.

Functional limitation

It may not be possible to adjust the lumbar support at very high and very low temperatures.

Seat massage

Principle

Using the seat massage helps relax the muscles and improve circulation in the lumbar region, which, in turn, helps prevent fatigue.

Seat massage menu



To go directly to the Seat Massage menu on the Interaction Unit, press the seat massage button on the seat.

Turning the seat massage on/off

To turn the seat massage on/off, proceed as follows:

1. Go through the menu as follows: Apps menu / "Vehicle" / "Seat comfort".
2. Select the desired seat.
3. "Seat massage"
4. Select the desired setting, as necessary.

The seat massage is stopped when the lumbar support is operated.

Calibrating the front seats

Principle

A Check Control message is displayed on the Interaction Unit when the electric seat adjuster is not working properly.

To restore the accuracy of the electric seat setting, the front seats must be calibrated.

Safety information

Warning

There is a danger of jamming when moving the seats. There is a risk of injury and risk of property damage. Make sure that the travel path of the seat is clear prior to any adjustment.

Calibrating the front seat

1. To calibrate the front seat, press the longitudinal direction switch on the seat forward for approx. 2 seconds until the seat stops.
2. Repeat step 1 until the seat stops then moves slightly forward.
3. Press the switch forward for approx. 2 seconds again until the seat stops.
4. Repeat step 3 until the seat stops then moves slightly backward.

As soon as the message on the Interaction Unit disappears, the calibration is complete. If the message remains active, repeat the calibration.

If the message is still shown after repeated calibration, have the vehicle checked by an authorized service center or another qualified service center or repair shop.

Rear seats

Principle

The backrest tilt and, depending on vehicle equipment, longitudinal direction can be adjusted as needed for the second seat row.

Safety information

⚠ Warning

There is a danger of jamming when moving the seats. There is a risk of injury and risk of property damage. Make sure that the travel path of the seat is clear prior to any adjustment.

⚠ Warning

Seats in the second row of seats are not locked when they are folded down and they can move. There is a risk of injury and risk of property damage. Only fold the seats in the second row down while loading. When driving without a load, fold back and lock the seats in the second row before driving away.

Longitudinal direction

⚠ Warning

If a seat is not locked, it may move unexpectedly while driving. Vehicle control could be lost. There is a risk of accident, injury, and property damage. After adjusting, move the seat forward or back slightly, making sure the seat engages properly.

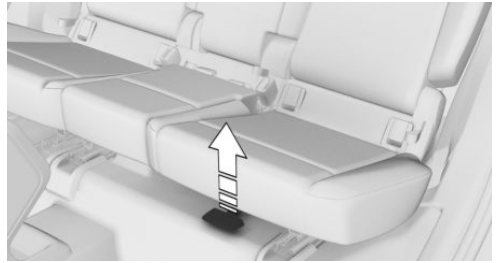

To adjust the longitudinal direction of the second row seats, pull the longitudinal direction lever at the front of the seat and push the seat in the desired direction.

Backrest tilt

1. Pull the loop on the side of the seat to unlock the backrest.

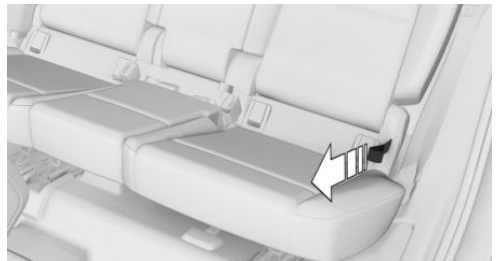

2. Apply or lift weight on the backrest as needed.

After setting the backrest tilt, make sure that the backrest engages correctly.

Comfort exit

Principle

The comfort exit setting makes it easier to get in/out of the vehicle by automatically adjusting the seat position and moving the seat back.

Activating/deactivating comfort exit

1. Go through the menu as follows: Apps menu / "Vehicle" / "Seat comfort" / "Comfort exit".
2. Select the desired setting.

Seat belts

Principle

The vehicle is fitted with five seat belts to ensure occupant safety. However, they can only offer protection when adjusted correctly.

Always make sure that seat belts are being worn by the occupants before driving off. The airbags supplement the seat belts as an additional safety device. The airbags do not replace seat belts.

All seat belt anchorage points are designed to achieve the best possible protective effect for the seat belts when used properly and with the correct seat settings.

The two outer seat belt buckles of the rear seats are intended for the persons sitting on the left and right.

The center seat belt buckle of the rear seats is intended for the person sitting in the middle.

Additional information:

Notes on sitting safely, refer to page [104](#).

Safety information

Warning

Use of a seat belt to buckle more than one person will potentially defeat the ability of the seat belt to serve its protective function. There is a risk of injury or danger to life. Do not strap in more than one person per single seat belt. Infants and children are not allowed on an occupant's lap, and must be transported and secured in designated child restraint systems.

Warning

The protective effect of safety gear, including seat belts, can be limited or lost when seat belts are fastened incorrectly. An incorrectly fastened seat belt can cause additional injuries, for instance in the event of an accident, braking or evasive maneuvers. There is a risk of injury or danger to life. Make sure that all occupants are wearing seat belts correctly.

Warning

With a rear seat backrest that is not locked, the protective effect of the middle seat belt is not guaranteed. There is a risk of injury or danger to life. If you are using the middle seat belt, lock the wider rear seat backrest.

Warning

The protective effect of safety gear, including seat belts, may not be fully operational or fail in the following situations:

- The seat belts or seat belt buckles are damaged, soiled, or changed in any other way.
- Seat belt tensioners or seat belt winders were modified.

Seat belts can be imperceptibly damaged in the event of an accident. There is a risk of injury or danger to life. Keep clean and do not modify: seat belts, seat belt buckles, seat belt tensioners, seat belt winders, and seat belt anchors. After an accident, have the seat belts checked by an authorized service center or another qualified service center or repair shop.

Correct use of seat belts

To use the seat belts correctly, note the following:

- Wear the seat belt tight to your body over your lap and shoulders, without twisting it.
- Wear the seat belt deep on your hips over your lap. The seat belt must not press on your stomach.
- Do not rub the seat belt against sharp edges, or guide it or jam it in across hard or fragile objects.
- Avoid thick clothing.
- Re-tighten the seat belt frequently upward around your upper body area.

Buckling the seat belt

1. To fasten the seat belt, guide the seat belt slowly over the shoulder and hip.
2. Insert the buckle tongue into the seat belt buckle. The seat belt buckle must engage audibly.

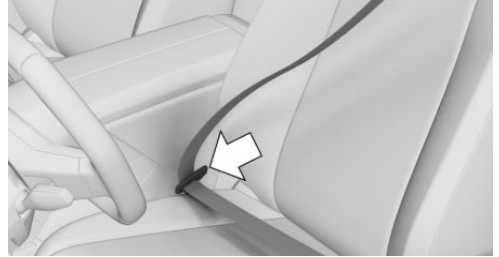

To ease accessibility to the seat belt buckle, an adjustable slider is available on the belt to help position the buckle when not in use.

Unbuckling the seat belt

1. To open the seat belt, hold the seat belt firmly.
2. Press the red button on the seat belt buckle.
3. Guide the seat belt back into the seat belt winder.

Middle seat belt in the rear

Buckling the seat belt

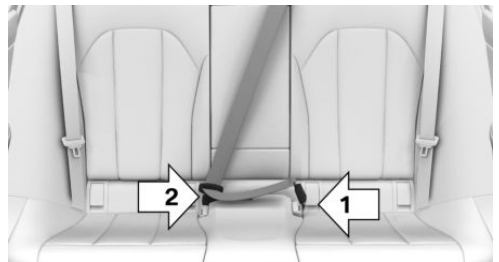

1. To fasten the middle seat belt in the rear, pull the belt tongues out of the mount in the roof.
2. Insert the lower buckle tongue into the belt lock, arrow 1.
3. Insert the upper buckle tongue into the seat belt buckle, arrow 2.
The seat belt buckles must engage audibly.

Unbuckling the seat belt

1. To open the middle seat belt in the rear, hold the seat belt firmly.
2. Press the red button on the seat belt buckle.
3. Open the belt lock, arrow 2, with the buckle tongue, arrow 1.

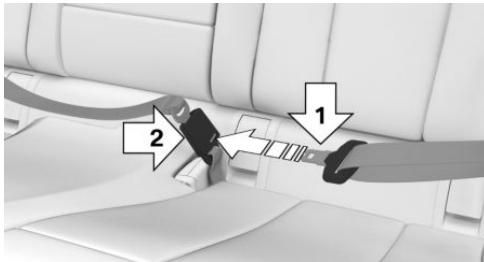

4. Guide the seat belt to the mount in the roof.

Seat belt reminder

Principle

The Seat Belt Warning warns the driver if the seat belts are not fastened.





General information

The seat belt reminder becomes active in the following situations:

- When the seat belt on the driver's side or on the passenger's side is not fastened.
- When the seat belt is unfastened while driving.
- When objects are lying on a seat.

Interaction Unit view

The indicator light on the Interaction Unit illuminates when drive-ready state is turned on and when the Seat Belt Warning is on. A Check Control message is displayed where applicable. Check whether the seat belt has been fastened correctly.

Icon	Meaning
	Seat belt on the driver's seat is not buckled.
	Seat belt on the passenger seat or another seat in the vehicle is not buckled.
	Seat belt is buckled on the corresponding seat.
	Seat belt is not buckled on the corresponding seat.

Rear Occupant Alert

Principle

At the end of the drive, the Rear Occupant Alert informs the driver that occupants may be present on the rear seats.

General information

If a door with access to the rear seat row is operated within 30 minutes before starting a drive, a notice appears on the control display and a signal tone sounds at the end of the drive.

If the drive is continued within 30 minutes, the notice is displayed again after the drive is complete.

Activating/deactivating the Rear Occupant Alert

To activate or deactivate the Rear Occupant Alert, proceed as follows:

1. Go through the menu as follows: Apps menu / "Vehicle" / "Rear Occupant Alert".
2. Select the desired setting.

Front head restraints

Safety information

Warning

Removal or incorrect adjustment of head restraints can cause injuries in the head and neck area. There is a risk of injury.

- Before driving, install the removed head restraints on the occupied seats.
- Adjust the head restraint so its center supports the back of the head at as close to eye level as possible.
- Adjust the distance so that the head restraint is as close as possible to the back of the head. Adjust the distance via the backrest tilt as needed.
- For manually adjustable head restraints: After adjusting, make sure that the head restraint is correctly engaged.

Warning

Body parts can be jammed when moving the head restraint. There is a risk of injury. Make sure that the area of movement is clear when moving the head restraint.

Warning

Objects on the head restraint reduce the protective effect in the head and neck area. There is a risk of injury.

- Do not use seat or head restraint covers.
- Do not hang objects, for instance clothes hangers, directly on the head restraint.
- Only use accessories that have been determined to be safe for attachment to a head restraint.
- Do not use any accessories, for instance pillows, while driving.

Adjusting the height

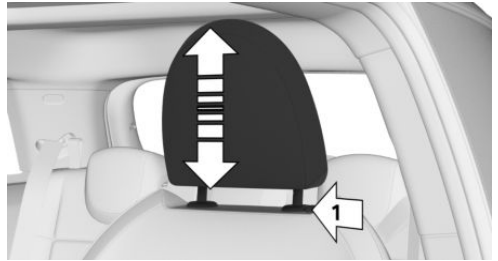

- To raise the height of the head restraint, push the head restraint upward.
- To lower the height of the head restraint, press the release button on the backrest, arrow 1, then push the head restraint downward.



John Cooper Works sport seat: Adjusting the height

The height of the head restraints cannot be set.

Adjusting the distance

The backrest tilt is used to set the distance between the head restraint and the back of the seat occupant's head.

Adjust the distance so that the head restraint is as close as possible to the back of the head.

Removing/attaching head restraints

Only remove the head restraint if no one will be sitting in the seat in question.

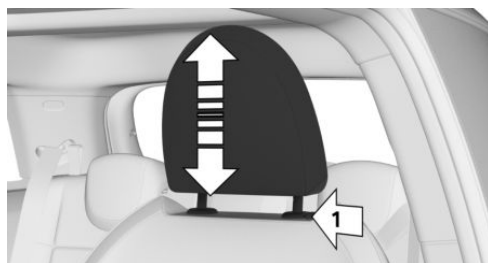

1. Raise the head restraint to the resistance point.
2. Press the release button on the backrest, arrow 1, then pull the head restraint completely out.

Proceed in the reverse order to install the head restraint.

John Cooper Works sport seat: Removing head restraints

The head restraints cannot be removed.

Rear head restraints

Safety information

Warning

Removal or incorrect adjustment of head restraints can cause injuries in the head and neck area. There is a risk of injury.

- Before driving, install the removed head restraints on the occupied seats.
- Adjust the head restraint so its center supports the back of the head at as close to eye level as possible.
- Adjust the distance so that the head restraint is as close as possible to the back of the head. Adjust the distance via the backrest tilt as needed.
- For manually adjustable head restraints: After adjusting, make sure that the head restraint is correctly engaged.

Warning

Body parts can be jammed when moving the head restraint. There is a risk of injury. Make sure that the area of movement is clear when moving the head restraint.

Warning

Objects on the head restraint reduce the protective effect in the head and neck area. There is a risk of injury.

- Do not use seat or head restraint covers.
- Do not hang objects, for instance clothes hangers, directly on the head restraint.

- Only use accessories that have been determined to be safe for attachment to a head restraint.
- Do not use any accessories, for instance pillows, while driving.

Folding down the center head restraint

Principle

To improve the view to the rear, the center head restraint can be folded to the rear. Only push the head restraint down if no one will be sitting in the center seat.

Folding the head restraint

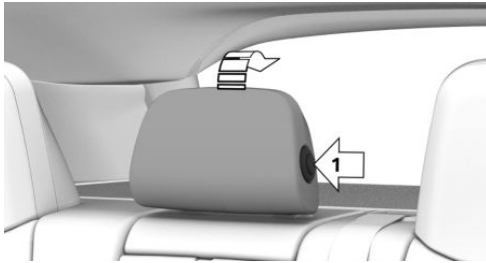

Press button, arrow 1, and fold the head restraint back.

To return the head restraint to its initial position, fold the head restraint forward as far as it will go until it engages.

Adjusting the height

To improve the view of the rear, the rear head restraints can be lowered completely. Set seat to the lowest position only if no one will be sitting in the seat.



- To raise the head restraint, push the head restraint upward.
- To lower the head restraint, press the release button on the backrest, arrow 1, then push the head restraint downward.

Center head restraint: Adjusting the height

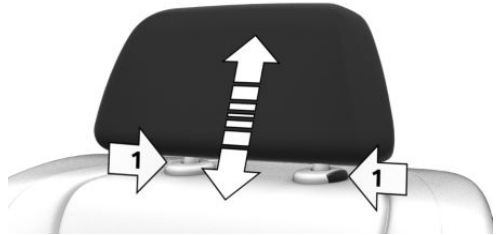

- To raise the head restraint, push the head restraint upward.
- To lower the head restraint, press both buttons on the backrest, arrows 1, then push the head restraint downward.

Removing/attaching head restraints

Only remove the head restraint if no one will be sitting in the seat in question.

1. Fold down the corresponding rear seat backrest.

To fold down the rear seat backrest, follow the steps for enlarging the cargo area.

2. Raise the head restraint to the resistance point.
3. Press both release buttons on the backrest, arrow 1, simultaneously then pull the head restraint completely out.

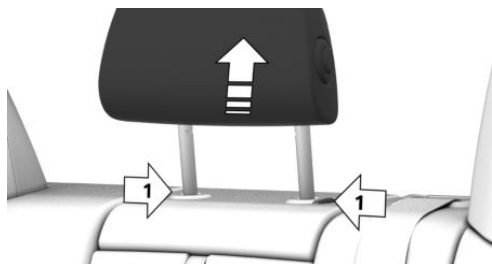

Additional information:

Enlarging the cargo area, refer to page 308. Proceed in the reverse order to install the head restraint.

Exterior mirrors

Principle

The front passenger's side exterior mirror is more curved than the driver's side mirror.

Exterior mirror settings are saved to the active MINI ID or driver profile. If the MINI ID or driver profile is reactivated later, the saved position is brought up automatically.

Depending on vehicle equipment, the driver's side exterior mirror also dims automatically. Photocells in the interior mirror are used to control this.

Depending on vehicle equipment, both exterior mirrors are heated automatically as necessary and when drive-ready state is on.

General information

The current exterior mirror adjustment can be stored using the memory function.





Safety information

Warning

Objects in the mirror are closer than they appear. The distance to the road users behind could be incorrectly estimated, for instance while changing lanes. There is a risk of accident, injury, and property damage. Estimate the distance to the traffic behind by looking over your shoulder.

Overview



Icon	Meaning
	Fold the exterior mirror in and out.
	Adjust the exterior mirrors.
	Select left exterior mirror, Automatic Curb Monitor.
	Select right exterior mirror.

Selecting the exterior mirror

-  To select the left exterior mirror, press the corresponding button

on the driver's door. The LED illuminates.

-  To select the right exterior mirror, press the corresponding button on the driver's door. The LED illuminates.

Adjusting the exterior mirrors



On the driver's door, press the button for adjusting the exterior mirrors.

The selected exterior mirror moves along with the button movement.

Malfunction

In case of an electrical malfunction, adjust the exterior mirror by pressing on the edges of the mirror glass.

Folding in/folding out the exterior mirrors

NOTICE

Depending on the vehicle width, the vehicle can be damaged in car washes. There is a risk of property damage. Before washing, fold in the mirrors by hand or with the button.



To fold the exterior mirrors in/out, press the button for folding the exterior mirrors in/out on the driver's door.

Folding is possible up to a speed of approx. 15 mph/20 km/h.

Folding the exterior mirrors in and out is helpful in the following situations:

- In car washes.
- On narrow roads.

Exterior mirrors that were folded in are folded out automatically at a speed of approx. 25 mph/40 km/h.

Automatic dimming

The exterior mirror on the driver's side is automatically dimmed. Photocells in the interior mirror are used to control this.

Automatic Curb Monitor

Principle

Depending on vehicle equipment, the mirror glass on the front passenger's side is tilted downward when reverse gear is engaged. This improves your view of the curb and other low-lying obstacles when parking, for instance.

Activating the Automatic Curb Monitor

1.  To activate the Automatic Curb Monitor, press the exterior mirror button on the driver's door. The LED illuminates.
2. Engage selector lever position R.

When the trailer power socket is occupied or trailer towing is activated, the Automatic Curb Monitor is deactivated.

Deactivating the Automatic Curb Monitor

 To deactivate the Automatic Curb Monitor, press the exterior mirror button on the front passenger door. The LED illuminates and the LED of the driver's side outside mirror goes out.

Interior mirror, manually dimmable

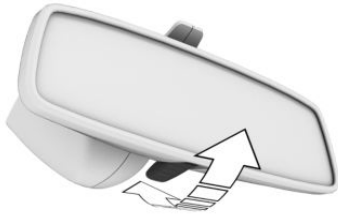

To reduce blinding glare from the interior mirror, tilt the lever forward on the manually dimming interior mirror.

Interior mirror, automatic dimming feature

Principle

The interior mirror is dimmed automatically.

Photocells in the mirror glass and on the rear of the mirror are used to control glare.

Overview



Functional requirements

The following functional requirements apply for the automatic dimming interior mirror:

- Keep the photocells clean.
- Do not cover the area between the interior mirror and the windshield.

Steering wheel

Safety information

Warning

Steering wheel adjustments while driving can lead to unexpected steering wheel movements. Vehicle control could be lost. There is a risk of accident, injury, and property damage. Adjust the steering wheel while the vehicle is stationary only.

Manual steering wheel adjustment

The position of the steering wheel can be changed by manually adjusting the height and longitudinal direction.

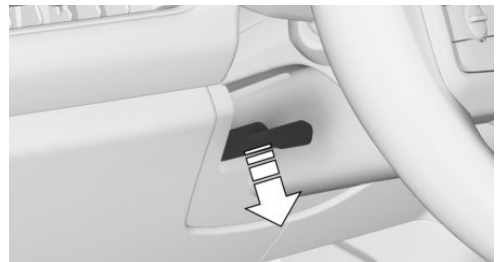

1. On the steering column, press the release lever all the way down.
2. Grip the steering wheel with both hands and move the steering wheel to the preferred height and angle to suit your seat position.
3. Fold the lever back up.

Memory function

Principle

The following settings can be stored and, if necessary, retrieved using the memory function:

- Seat position.
- Exterior mirror adjustment.
- Depending on the equipment: height of the Head-up display.

General information

Two memory locations with different settings can be set for each driver profile.

The settings for the lumbar support will not be stored.

Safety information

Warning

Using the memory function while driving can lead to unexpected seat or steering wheel movements. Vehicle control could be lost. There is a risk of accident, injury, and property damage. Only retrieve the memory function when the vehicle is stationary.

Warning

There is a danger of jamming when moving the seats. There is a risk of injury and risk of property damage. Make sure that the travel path of the seat is clear prior to any adjustment.

Overview



The memory buttons are located on the driver's seat.

Storing settings

To save settings to memory using the buttons, proceed as follows:

1. Set the desired position.
2.  Press the SET button on the seat. The LED illuminates.
3. Press memory button 1 or 2 while the LED is illuminated. A successful save is indicated by a signal tone.

To save settings to memory using the Interaction Unit, proceed as follows:

1. Go through the menu as follows: Apps menu / "Vehicle" / "Seat comfort".
2. Select the desired seat position.
3. Tap the icon for the SET button.

Calling up settings

To access settings saved to memory using the buttons, proceed as follows:

Press the desired memory button 1 or 2.

The stored position is called up.

The procedure stops when a seat setting switch or one of the memory buttons is pressed again.

The adjustment of the seat position on the driver's side is interrupted after a short time while driving.

To access settings from memory using the Interaction Unit, proceed as follows:

1. Go through the menu as follows: Apps menu / "Vehicle" / "Seat comfort".
2. Select the desired seat.
3. Select the desired seat position.

Seat climate control

Various climate control functions are available for the seats.

Additional information:

Climate control, refer to page [283](#).



Transporting children safely

Vehicle features and options

This chapter describes model-specific equipment, systems, and functions that are currently available, or may become available in the future, even if they are not present in the vehicle.

Additional information:

Vehicle equipment, refer to page 8.

The right place for children

Safety information

Warning

Unattended children or animals in the vehicle can cause the vehicle to move and endanger themselves and traffic, for example, due to the following actions:

- Establishing standby.
- Releasing the parking brake.
- Opening and closing the doors or windows.
- Engaging selector lever position N.
- Using vehicle equipment.

There is a risk of accident, injury, and property damage. Do not leave children or animals unattended in the vehicle. Take the vehicle key with you when exiting and lock the vehicle.

Warning

A hot vehicle may result in death to persons, especially children, or animals. There is a risk of injury or danger to life. Do not leave people, especially children, or animals unattended in the vehicle.

Warning

Exposure to intense sunlight can cause child restraint systems and their components to become very hot. Persons may sustain burn injuries when touching the hot components. There is a risk of injury. Do not expose the child restraint system to direct sunlight or cover where necessary. If necessary, let the child restraint system cool down before transporting a child. Do not leave children unattended in the vehicle.

Children in the rear seat

General information

Accident research shows that the safest place for children is in the rear seat.

Children younger than 13 years of age or shorter than 5 ft/150 cm should be transported in the rear seat in suitable child restraint systems designed for the age, weight and size of the child. Children 13 years of age or older must wear a seat belt as soon as a suitable child restraint system can no longer be used due to their age, weight, or size.

Safety information

Warning

The seat belt cannot be fastened correctly on children shorter than 5 ft/150 cm without suitable additional child restraint systems. The protective effect of safety gear, including seat belts, can be limited or lost when seat belts are fastened incorrectly. An incorrectly fastened seat belt can cause additional injuries, for instance in the event of an accident, braking or evasive maneuvers. There is a risk of injury or danger to life. Secure children shorter than 5 ft/150 cm using suitable child restraint systems.

Children on the front passenger seat

General information

When using a child restraint system on the front passenger seat, make sure that the front passenger airbag is deactivated.

Additional information:

Automatic deactivation of front passenger airbag, refer to page 177.

Safety information

Warning

Active front passenger airbags can injure a child in a child restraint system when the airbags are deployed. There is a risk of injury. Make sure that the front passenger airbags are deactivated and that the PASSENGER AIRBAG OFF indicator light illuminates.

Installing child restraint systems

General information

When selecting, installing, and using child restraint systems, pay close attention to the operating and safety instructions provided by the child restraint system manufacturer.

Safety information

Warning

The protective effect of child restraint systems and their fastening systems which have been damaged or exposed to an accident can be limited or lost. A child cannot be properly restrained in the event of an accident, braking or evasive maneuvers. There is a risk of injury or danger to life.

Do not use child restraint systems which have been damaged or exposed to an accident.

If attachment systems have been damaged or strained by an accident, have them checked and replaced by an authorized service center or another qualified service center or repair shop.

Warning

The stability of the child restraint system is limited or compromised with incorrect seat setting or improper installation of the child seat. There is a risk of injury or danger to life. Make sure that the child restraint system fits securely against the backrest. If possible, adjust the backrest tilt for all affected backrests and correctly adjust the seats. Make sure that seats and backrests are securely engaged or locked. If possible and necessary, adjust



the height of the head restraints or remove them.

Before installation

Before installing child restraint systems, ensure that the rear seat backrests are locked.

Move the rear seats into the rearmost position to facilitate installation of the child restraint system.

On the front passenger seat

Deactivating the airbag

Warning

Active front passenger airbags can injure a child in a child restraint system when the airbags are deployed. There is a risk of injury. Make sure that the front passenger airbags are deactivated and that the PASSENGER AIRBAG OFF indicator light illuminates.

After mounting a child restraint system on the front passenger seat, make sure that the front passenger airbag is deactivated.

Additional information:

Automatic deactivation of front passenger airbag, refer to page 177.

Seat position and height

After installing a child restraint system, move the front passenger seat as far back as it will go and, if possible, to the highest position. This seat position and height ensure the best possible position for the belt and offers optimal protection in the event of an accident.

After mounting a universal child restraint system, adjust the backrest tilt so that the seat belt sits properly.

If the upper attachment point of the seat belt is located in front of the seat belt guide of the child seat, move the front passenger seat carefully forward until the best possible seat belt guide position is reached.

Backrest width

Adjustable backrest width: Before installing a child restraint system on the front passenger seat, open the backrest width completely. Do not change the backrest width again and do not call up a memory position.

Child seat security

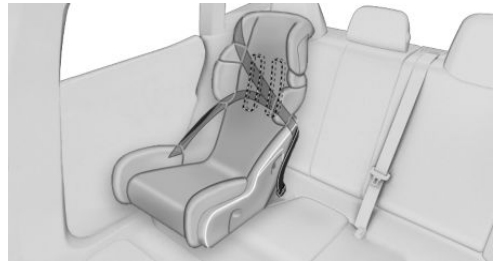

The seat belts in the rear and the front passenger seat belt can be permanently locked to fasten child restraint systems.

Locking the seat belt

1. Pull out the seat belt strap completely.
2. Secure the child restraint system with the seat belt.
3. Allow the seat belt strap to be pulled in, then pull it tight against the child restraint system. The seat belt is disabled.

Unlocking the seat belt

1. Open the seat belt buckle.
2. Remove the child restraint system.
3. Allow the seat belt strap to be pulled in completely.

Lower anchors for child restraint systems

Principle

LATCH child restraint systems establish a secure connection to the vehicle in combination with LATCH anchors.

General information

LATCH: Lower Anchors and Tether for Children.

When selecting, installing, and using child restraint systems, pay close attention to the operating and safety instructions provided by the child restraint system manufacturer.

Mounts for lower anchors

General information

The lower anchors may be used to attach the CRS to the vehicle seat up to a combined child and CRS weight of 65 lbs/30 kg when the child is restrained by the internal harnesses.

Safety information

Warning

If the lower anchors on child restraint system are not engaged correctly, the child restraint system will not be able to provide suitable protection. There is a risk of injury or danger to life. Make sure that the lower anchors are correctly engaged and that the child restraint system fits securely against the backrest.

Warning

The mounts for the lower anchors and attachment points of the child restraint system are intended for attaching child restraint systems only. If other objects are attached, the mounts or attachment points can be damaged. There is a risk of injury and risk of property damage. Only attach child restraint systems at the corresponding mounts for the lower anchors or attachment points.

Position

Icon	Meaning
	<p>The corresponding icon shows the mounts for the lower LATCH anchors.</p> <p>Seats equipped with lower anchors are marked with a pair (2) of LATCH icons.</p> <p>For vehicles equipped with a middle seat:</p> <p>It is not recommended to use the inner lower anchors of standard outer LATCH positions to fasten a child restraint system on the middle seat. Use the vehicle seat belt instead for the middle seat.</p>

Before attaching child restraint systems

Before installing a child restraint system, pull the seat belt away from the lower anchors of the child restraint system.



Installing child restraint systems

To install the child restraint system in the vehicle, proceed as follows:

1. Mount the child restraint system in accordance with the instructions from the child seat manufacturer.
2. Make sure that the child restraint system anchors engage correctly on both sides in the lower seat mounts.

Child restraint systems with tether strap

General information

When attaching child restraint systems to the upper attachment points, observe the specifications and the operating and safety information of the child restraint system manufacturer.

Safety information

Warning

If the upper retaining strap is incorrectly used for the child restraint system, the protective effect is reduced. There is a risk of injury. Ensure that the upper retaining strap is guided to the upper attachment point without twisting and not over sharp edges.

Warning

If the rear seat backrest is not locked, the protective effect of the child restraint system is limited or nonexistent. In certain situations, for instance braking maneuvers or in case of an accident, the rear seat backrest can fold forward. There is a risk

of injury or danger to life. Make sure that the rear seat backrests are locked.

Warning

The mounts for the lower anchors and attachment points of the child restraint system are intended for attaching child restraint systems only. If other objects are attached, the mounts or attachment points can be damaged. There is a risk of injury and risk of property damage. Only attach child restraint systems at the corresponding mounts for the lower anchors or attachment points.

Attachment points for upper retaining strap

Icon	Meaning
	The respective icon shows the attachment point for the upper retaining strap. Seats with an upper top tether are marked with this icon. It is located on the rear seat backrest, the rear shelf or the rear seat.

Routing the retaining strap

Rear seat

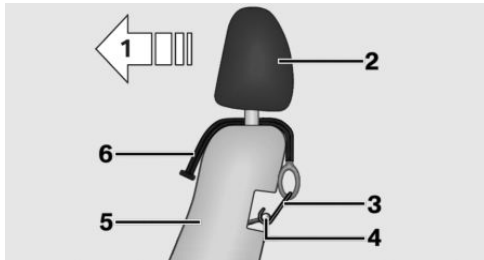

- 1 Driving direction
- 2 Head restraint
- 3 Hook for upper retaining strap
- 4 Attachment point
- 5 Seat backrest
- 6 Upper retaining strap

Attaching the upper retaining strap to the attachment point

Rear seat

To attach the upper strap to the attachment point, proceed as follows:

1. Raise the head restraint as needed.
2. Guide the upper strap between the head restraint rods, or along both sides of the head restraint rods, to the attachment point.
3. If there is a retaining strap, run it between the backrest and the cargo cover.
4. Attach the strap's hook to the attachment point.
5. Tighten the strap.

Locking doors and windows in rear

Principle

To prevent the rear doors and windows from being opened from the inside, there is a switch on the corresponding rear door frame as well as a safety switch on the driver's door armrest.



General information

In certain situations it may be advisable to secure the rear doors and windows, for instance when transporting children.

Doors



To secure the rear doors, release/lock the safety switch on the rear door using the integrated key.

Icon	Meaning
	Child safety lock.
	Apply the child safety lock.

The door can now be opened from the outside only.

After locking, make sure that the door cannot be opened from the inside.



Safety switch for the rear

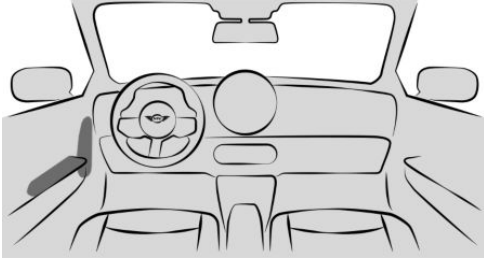

The safety switch for the rear is located on the driver's door.

Various functions are locked and cannot be operated in the rear such as the power windows.



To lock rear functions, press the safety switch in the driver's door.

The LED is illuminated when the safety function is turned on.

Various functions are locked and cannot be operated in the rear such as the power windows.

Driving

Vehicle features and options

This chapter describes model-specific equipment, systems, and functions that are currently available, or may become available in the future, even if they are not present in the vehicle.

Additional information:

Vehicle equipment, refer to page 8.

Start/Stop switch

Principle

The Start/Stop switch can be used to turn vehicle operating states on/off.

Overview



The Start/Stop switch is labeled POWER and located on the switch cluster.

Turning on the drive-ready state

Drive-ready state turns on when the Start/Stop switch is pushed while depressing the brake pedal. Pressing the Start/Stop switch again turns drive-ready state back off, and turns standby back on.

Drive-ready state cannot be switched on as long as the charging cable is connected.

Additional information:

- Drive-ready state, refer to page 47.
- Standby state, refer to page 46.
- Charging cable, refer to page 334.

Driving off

To drive off with the vehicle, proceed as follows:

1. Close the driver's door.
2. Depress the brake pedal.
3. Turn the Start/Stop switch.
4. Engage the desired selector lever position, e.g., D or R.
5. Release the parking brake.
6. To drive off, release the brake pedal and press the accelerator pedal.

Acoustic pedestrian protection

Depending on vehicle equipment and national-market version, Acoustic Pedestrian Protection produces a continuous driving noise in vehicles with electric or electrically-assisted drives.

- When the vehicle is stationary and drive-ready state is on, as soon as selector lever position P is disengaged.
- With electric driving up to approx. 20 mph/30 km/h.

A speaker system broadcasts the noise to the environment. As a result, other road users, for instance pedestrians or cyclists, can better perceive the vehicle.



Drive-ready state in detail

Safety information

Warning

An unsecured vehicle can begin to move and possibly roll away. There is a risk of accident, injury, and property damage. Before leaving the vehicle, secure the vehicle against rolling away.

In order to ensure that the vehicle is secured against rolling away, follow the following:

- Set the parking brake.
- Automatic transmission: Make sure that selector lever position P is engaged.
- On uphill grades or on downhill slopes, turn the front wheels in the direction of the curb.
- On uphill grades or on downhill slopes, also secure the vehicle, for instance with a wheel chock.

Turning on the drive-ready state

To turn on drive-ready state, proceed as follows:

1. Close the driver's door.
2. Depress the brake pedal.
3. Turn the Start/Stop switch.

A signal tone sounds. Drive-ready state is switched on.

Interaction Unit view



The READY on the Interaction Unit shows that the vehicle is ready to drive.

Driving off

Functional requirements

Driving is possible when the following prerequisites are met:

- The vehicle battery is sufficiently charged.
- The driver's door is closed.
- The charging cable is disconnected.

Driving

To drive, proceed as follows:

1. Depress the brake pedal.
2. Switch on drive-ready state.
3. Engage selector lever position D, B, or R.
4. Press the accelerator pedal to drive off.

State of charge in strong temperature fluctuations

The vehicle may not start the next time it is driven if the temperature has fluctuated significantly and the high-voltage battery charge is low. Recharge the vehicle promptly when the battery charge is low.

Selector lever positions

Display

The engaged selector lever position is shown on the Interaction Unit and next to the selector lever, e.g., P.

Gear position D

Selector lever position D is the gear position used for normal driving.

The vehicle drives off slowly when the brake pedal is released.

R reverse gear

To reverse, engage selector lever position R. Only engage reverse gear when the vehicle is stationary.

The vehicle drives off slowly when the brake pedal is released.

N Neutral

To push the vehicle or have it coast without using the drive system, engage selector lever position N, e.g., in car washes.

Parking brake P

General information

In position P, the drive is blocked by the transmission, e.g., to park the vehicle.

Only press parking brake button P when the vehicle is stationary.

Before leaving the vehicle, make sure to engage the parking brake. Otherwise, the vehicle may begin to move.

P is engaged automatically

The transmission lock engages automatically in situations like the following:

- After drive-ready state is turned off and selector lever position D, R, or B is engaged.
- If the driver's seat belt is unbuckled and the driver's door is opened while the vehicle is stationary and selector lever position D, R, or B is engaged.
- After standby state is switched off, if selector lever position N is engaged.

Before leaving the vehicle, make sure to engage the parking brake. Otherwise, the vehicle may begin to move.

Additional information:

Parking brake, refer to page [137](#).

B gear position with high energy recovery

Principle

For high energy recovery, engage selector lever position B.

General information

Selector lever position B offers the following:

- High level of energy recovery when the accelerator pedal is released.
- Major deceleration when the accelerator pedal is released, if necessary until the vehicle comes to a standstill.
- Enhanced braking effect via the mechanical brake after the vehicle is stopped on an uphill/downhill gradient.
- The vehicle does not drive off when the brake pedal is released.

Engaging selector lever positions

General information

To prevent the vehicle from moving when a gear is engaged or when reversing, press and hold the brake pedal until the vehicle drives off.

Functional requirements

To engage a selector lever position, the following functional requirements must be met:

- To switch from parking brake button P to another selector lever position, first turn on drive-ready state and press the brake pedal.
- The parking brake cannot be disengaged until all technical prerequisites are met.
- Before shifting out of selector lever position P, disconnect the charging cable from the vehicle. Otherwise, the gear-shift request will not be executed.

Engaging a selector lever position

To engage selector lever positions, proceed as follows:

1. Fasten the driver's seat belt.
2. Push the selector lever in the desired direction, past the resistance point if necessary. The selector lever automatically returns to the center position when released.

To switch between selector lever position D and B, tap the selector lever to D/B.

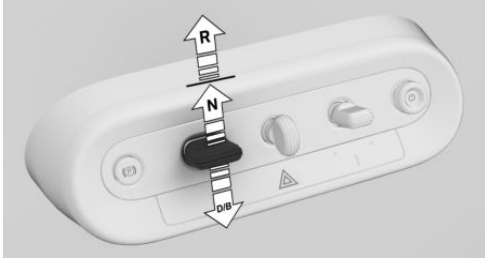

Engaging selector lever position P

Only push the parking brake button when the vehicle is stationary.



(P) To engage selector lever position P and the parking brake, press the parking brake button on the switch cluster.

The parking brake is applied and the transmission lock is engaged.

Rolling or pushing the vehicle

General information

In some situations, the vehicle is supposed to roll without its own drive for a short distance, for instance in a car wash or to be pushed.

Engaging selector lever position N

⚠ NOTICE

Selector lever position P is automatically engaged when standby state is switched off. The wheels are blocked. There is a risk of property damage. Do not switch off standby if the vehicle is meant to coast, e.g., in a car wash.

To engage selector lever position N, proceed as follows:

1. Depress the brake pedal.
2. Switch on drive-ready state.
3. Engage selector lever position N.
4. Switch off drive-ready state.

In this way, standby state remains switched on, and a Check Control message is displayed.

The vehicle can roll.

Whether standby state is on or not, selector lever position P is engaged automatically after approx. 35 minutes.

If the system is not operational, you may not be able to change the selector lever position.

Electronically unlock the transmission lock, if needed.

Electronic unlocking of the transmission lock

General information

Unlock the transmission lock electronically, e.g., to maneuver the vehicle out of a hazardous area in the event of a malfunction.

Before unlocking the transmission lock, secure the vehicle against rolling away, for instance with a wheel chock.

Engaging selector lever position N

To engage selector lever position N, proceed as follows:

1. Quickly turn the Start/Stop switch three times without pressing the brake.
2. Depress the brake pedal.
3. Within 30 seconds, press the selector lever to position N until position N appears on the selector lever.
A Check Control message is displayed.
4. Maneuver the vehicle from the hazardous area and secure it against rolling away.

Turning off drive-ready state

Once the vehicle is parked, the electrical system may produce audible operating noises, e.g., when cooling the high-voltage battery.

To turn off drive-ready state after stopping, proceed as follows:

1. Press the brake pedal and engage the parking brake.
2. Turn the Start/Stop switch on the switch panel.

The READY indicator goes out and a signal tone sounds.

The drive-ready state is switched off automatically if the driver's seat belt is not buckled when the driver's door is opened.

If leaving the vehicle stationary for longer periods, follow the instructions in the Mobility chapter.

Additional information:

Service life of high-voltage battery, long stationary periods, and vehicle shutdown, refer to page 345.

Driving in detail

Safety information

Warning

The braking effect of the electric motor can be stronger than for a vehicle with combustion engine. Abrupt braking and slow-down may confuse other road users. There is a risk of accident, injury, and property damage. Carefully release the accelerator pedal. Adjust driving style to traffic conditions. Watch surrounding traffic closely and actively intervene where appropriate

Warning

When driving in electric mode, pedestrians and other road users might pay less attention to the vehicle due to the lack of engine noise. There is a risk of accident, injury, and property damage. Adjust driving style to traffic conditions. Watch surrounding traffic closely and actively intervene where appropriate

**Warning**

Without energy recovery, the braking effect of the electric motor is unavailable. The vehicle could roll further than anticipated. There is a risk of accident, injury, and property damage. Adjust driving style to traffic conditions. Watch surrounding traffic closely and actively intervene where appropriate

Accelerator pedal positions, displays

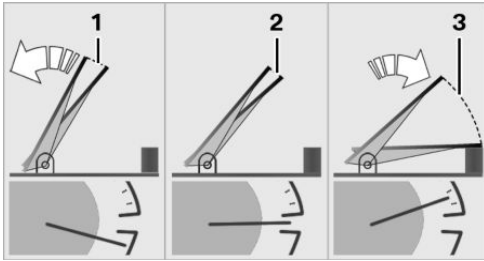

- 1 Deceleration and energy recovery, CHARGE
- 2 Rolling
- 3 Acceleration or constant speed: POWER

Deceleration and recuperative braking

Deceleration

The degree of the deceleration depends on the selector lever position, the energy recovery setting and the driving situation.

Depending on the degree of the deceleration, the brake lights will come on without depressing the brake pedal.

Deceleration is very pronounced in selector lever position B.

Energy is recovered during deceleration, and the high-voltage battery is charged.

Reduced deceleration

Warning

Without energy recovery, the braking effect of the electric motor is unavailable. The vehicle could roll further than anticipated. There is a risk of accident, injury, and property damage. Adjust driving style to traffic conditions. Watch surrounding traffic closely and actively intervene where appropriate

Energy recovery, and thus deceleration, is reduced to avoid unstable driving conditions, e.g., if the wheels are in danger of locking.

Energy recovery: CHARGE

Energy recovery is also called recuperation. With energy recovery, the electric motors act as alternators when decelerating and convert the kinetic energy of the vehicle to electrical energy.

The high-voltage battery is partially recharged via energy recovery.

Energy can be recovered if the following requirements are met:

- The vehicle is moving.
- Selector lever position B, D, or R is engaged.
- The accelerator pedal is not depressed or only slightly depressed.

The energy recovery is shown on the Interaction Unit's power gauge.

Energy cannot be recovered in situations like the following:

- Selector lever position P is engaged.
- While driving stability control systems are on or controlling the vehicle, even though this is not shown by an indicator light.

- The high-voltage battery is fully charged.
- When the high-voltage battery temperature is very low or very high.
In winter the energy recovery may be temporarily unavailable after startup.

Additional information:

Power gauge, refer to page 151.

Driving situations for energy recovery

Decelerating while driving can be used for energy recovery.

The following driving situations may be suitable for this:

- Decelerating on a downhill gradient.
- Decelerating before a red light.

Avoid late or strong braking. Instead, decelerate the vehicle using energy recovery.

Strength of recuperative braking

In selector lever position B, the energy recovery is high and the deceleration is very pronounced.

When driving in selector lever position D, the energy recovery level can be adjusted via the Interaction Unit.

- Adaptive energy recovery: The energy recovery and deceleration are automatically adapted to the respective driving situation.
- If the energy recovery is set to high, the vehicle decelerates sharply and more energy is returned to the high-voltage battery.
- Average energy recovery.
- If the energy recovery is set to low, the vehicle decelerates more slowly and less energy is returned to the high-voltage battery.

Additional information:

Adaptive recuperation, recuperative braking, refer to page 327.

Setting the strength of energy recovery

1. To configure the energy recovery level, go through the menu as follows: Apps menu / "Vehicle" / "Driving settings" / "Drivetrain and chassis" / "Energy recovery in D".
2. Select the desired setting.

What to do if high-voltage battery is fully charged

If the high-voltage battery is fully charged, the electric motor will be unable to recover additional energy when driving off.

To maintain the usual level of deceleration from energy recovery, the vehicle is decelerated by its normal brake when the accelerator pedal is released. This can cause the brake to overheat in certain situations, e.g., when driving downhill or applying continuous, gentle braking.

A Check Control message is displayed.

As such, the driver must apply the brake when driving on long downhill stretches with a fully charged high-voltage battery.

If necessary, adjust your charging strategy, e.g., do not fully charge the high-voltage battery before driving downhill.

High-voltage battery heavily discharged

If the high-voltage battery discharges significantly when driving, the drive power and some comfort functions are limited incrementally to extend the range.



High-voltage battery overheated

With a stationary vehicle

In isolated cases, it is possible for the high-voltage battery to overheat when the vehicle is stationary, e.g., with extreme outside temperatures and direct sunlight. Drive-ready state cannot be turned on if the high-voltage battery is overheated.

A Check Control message appears on the Interaction Unit.

Another message will indicate when drive-ready state is available again.

While driving

If the high-voltage battery heats up significantly while driving, the drive power is gradually reduced to cool the high-voltage battery. The POWER gauge on the Interaction Unit decreases.

If the temperature continues to rise, park the vehicle to cool the high-voltage battery.

If the power gauge falls to 0, the drive-ready state is switched off and the vehicle comes to a stop.

Launch Control

Principle

Under dry ambient conditions, Launch Control ensures optimal acceleration on roads with good traction.

General information

Using Launch Control causes premature component wear since this function represents a very heavy load for the vehicle.

Do not turn the steering wheel when driving off with Launch Control.

Do not use Launch Control when breaking in the vehicle.

Additional information:

Break-in, refer to page [312](#).

Driving off with Launch Control

To drive off with Launch Control, proceed as follows:

1. Switch on drive-ready state.
2. Activate Go Kart Mode.
3. Enable the driving dynamics setting: "SPORT PLUS".
4. With the left foot, press down forcefully on the brake.
5. Engage forward gear.
6. Press the accelerator pedal all the way down and hold.

Launch Control information is shown on the Interaction Unit.

7. Release the brake within a few seconds of the Launch Control information illuminating.

The vehicle accelerates.

Launch Control stays on as long as the Launch Control information is displayed and the accelerator pedal is not released.

Sport Boost function

Principle

The SPORT BOOST function can be used for upcoming acceleration, for example.

This function is operated using the shift paddle on the left side of the steering wheel.

The system prepares the vehicle.

The system may provide additional drive power for a limited time.

Overview



The shift paddle for the Sport Boost function is located on the steering wheel.

Using the function

- To activate the Sport Boost function, pull the shift paddle.
 - The function is active.
 - A countdown is shown on the Interaction Unit.
- Before the countdown has finished, depress the accelerator pedal.
 - The vehicle accelerates and uses the additional power provided as necessary.



BOOST is shown on the Interaction Unit.

The countdown can be restarted, for example if the function cannot be used immediately.

To restart the countdown, pull the shift paddle again.

Stopping the function

The function is automatically interrupted if the countdown has finished or if the function was used in the acceleration process.

Deactivating the function

Pull and hold the shift paddle until the BOOST indicator disappears.

MINI Modes

Principle

MINI Modes are used to adjust vehicle handling and customize the overall experience in the interior.

The various modes are used to adapt the vehicle to the respective situation.

General information

Depending on the equipment, the following systems are affected, for instance:

- Drive system.
- Steering.
- Suspension.
- Display on the Interaction Unit.
- Comfort functions in vehicle interior.
- MINI Sound.
- Lighting effects in vehicle interior.

Overview





The MINI Modes switch is located on the switch cluster and labeled EXPERIENCE.

Display

The selected mode is shown by specific colors and indicators on the Interaction Unit and Head-up display, depending on vehicle equipment.

MINI Modes in detail

General information

MINI Modes are used to adjust vehicle handling. They are also referred to as driving modes.

Various MINI Experience Modes can be used, depending on vehicle equipment.

Core Mode

Core Mode is a drive mode that provides for comfort-related settings.

Go Kart Mode

Go Kart Mode is a driving mode that provides increased vehicle agility.

Individual settings, e.g., for driving dynamics, chassis, and drive system, can be configured as needed.

"SPORT PLUS": Under Driving Dynamics, this setting deactivates Dynamic Stability Control, thus limiting driving stability.

Additional information:

- Dynamic Stability Control, refer to page 216.
- Setting for increased driving dynamics, refer to page 218.

Green Mode

Green Mode is a drive mode for tuning with optimized energy consumption and antici-

patory display. The interior lighting is also reduced here, for example.

MINI Experience Modes in detail

In addition to MINI Modes, there are also MINI Experience Modes. MINI Experience Modes are not used to adjust vehicle handling, but rather to customize the lighting effects in the interior, for example.

– Balance Mode

Balance Mode is a driving mode that ensures a pleasant ambiance and a relaxed drive.

– Personal Mode

Personal Mode is a mode that offers special customization options. A personalized background image, for example, can be chosen for the Interaction Unit.

– Timeless Mode

Timeless Mode is used when driving with the MINI retro design.

– Vivid Mode

Vivid Mode is a mode that ensures a vibrant audio experience and impressive ambient lighting effects in the vehicle interior.

– Trail Mode

Trail Mode is a mode that provides special views for driving off-road.

Additional information:

Driving on poor roads, refer to page 315.



Selecting a mode

To select the desired mode, proceed as follows:

1.  Press the MINI Modes button on the switch cluster.
2. Select the desired mode by pressing the switch again.

Configuring modes



Some modes can be configured individually. To configure the desired mode, proceed as follows:

1.  Press the MINI Modes button on the switch cluster.
2.  Tap the Settings icon on the Interaction Unit.
3. Select the desired settings.

Changing the start mode



Some modes can be set as the start mode. The set start mode activates when drive-ready state is turned on.

To configured the desired start mode, proceed as follows:

1.  Press the MINI Modes button on the switch cluster.
2.  Tap the Settings icon on the Interaction Unit.
3. Select the desired start mode.

Experience View

When a mode is activated, specific views are displayed on the Interaction Unit. Specific views can be unselected in the settings as follows:

1.  Press the MINI Modes button on the switch cluster.
2.  Tap the Settings icon on the Interaction Unit.
3. "Experience View"
4. Select the desired setting.

Drive-off assistant

Principle

On inclines, in selector lever position D or R, this system prevents the vehicle from rolling opposite the set driving direction and provides drive-off support.

Selector lever position B

The system prevents the vehicle from rolling away when the vehicle has come to a standstill and the accelerator pedal is not pressed.

Driving off

Engage a gear position and step on the accelerator pedal to drive off.

The parking brake is released automatically.

Depending on the vehicle load or driving situation, the vehicle may roll back slightly.

If necessary, activate Automatic Hold.

Additional information.

Automatic Hold, refer to page 140.

Parking brake

Principle

The parking brake is used to prevent the vehicle from rolling away when it is parked.

Safety information

Warning

An unsecured vehicle can begin to move and possibly roll away. There is a risk of accident, injury, and property damage. Before leaving the vehicle, secure the vehicle against rolling away.

In order to ensure that the vehicle is secured against rolling away, follow the following:

- Set the parking brake.
- Automatic transmission: Make sure that selector lever position P is engaged.
- On uphill grades or on downhill slopes, turn the front wheels in the direction of the curb.
- On uphill grades or on downhill slopes, also secure the vehicle, for instance with a wheel chock.

Warning

Unattended children or animals in the vehicle can cause the vehicle to move and endanger themselves and traffic, for example, due to the following actions:

- Establishing standby.
- Releasing the parking brake.
- Opening and closing the doors or windows.
- Engaging selector lever position N.
- Using vehicle equipment.

There is a risk of accident, injury, and property damage. Do not leave children or animals unattended in the vehicle. Take the vehicle key with you when exiting and lock the vehicle.

Overview

Button in the vehicle

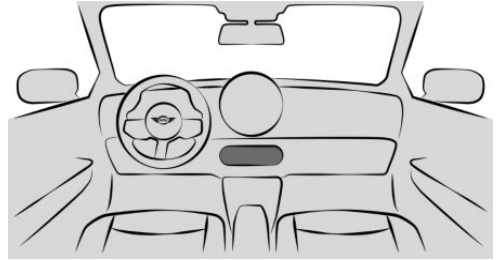

 The parking brake button is located on the switch cluster.

Setting the parking brake

With a stationary vehicle

 To engage the parking brake, press the parking brake button on the switch cluster.

The LED in the button illuminates.

 The indicator light on the Interaction Unit illuminates red.
The parking brake is engaged and transmission lock is engaged.

While driving

Using the parking brake while driving serves as emergency braking.

 To brake the vehicle, press and hold the parking brake button on the switch cluster. The vehicle brakes hard for as long as the button is pressed.

 The indicator light on the Interaction Unit illuminates red, a signal sounds, and the brake lights illuminate.

A Check Control message is displayed.

The parking brake is engaged and the transmission lock is set when the vehicle is stationary.

Engaging the parking brake automatically

In some situations, the parking brake is engaged automatically, e.g., through Automatic Hold.

Additionally, the system can be set to automatically engaging the parking brake when the drive-ready state is turned off.

To do so, go through the menu as follows: Apps menu / "Vehicle" / "Driving settings" / "Drivetrain and chassis" / "Apply automatically".

In selector lever position N, the parking brake will not be engaged automatically.

Releasing the parking brake

Releasing the parking brake manually

Follow these steps to manually release the parking brake:

1. Switch on drive-ready state.

2.  On the switch cluster, press the parking brake button with the brake applied or selector lever position P engaged.

The LED and the indicator light go out.

The parking brake is released.

The transmission lock remains engaged until a gear position is selected.

Releasing the parking brake automatically

The parking brake is released automatically when you drive off.

The LED and the indicator light go out.

Operating the parking brake on the Interaction Unit

The parking brake can also be engaged or disengaged using the Interaction Unit. Additionally, further information is displayed.

1. To operate the parking brake on the Interaction Unit, go through the menu as follows. Apps menu / "Vehicle" / "Driving settings" / "Drivetrain and chassis" / "Apply parking brake".
2. Select the desired setting.

Malfunction

If the parking brake fails or malfunctions, secure the vehicle so that it does not roll away before you exit.

A Check Control message appears on the Interaction Unit.

Secure the vehicle against rolling away, for instance with a wheel chock, after getting out of the vehicle.

After a power interruption

To reestablish parking brake operability after a power interruption, an initialization may be required.

1. Turn on standby state.

2.  Press the parking brake button.

3.  Press the parking brake button again after 2 seconds.

The Check Control messages for the parking brake go out.

Possible function-related noises are normal.

 The red indicator light shows that the parking brake is ready again.

Automatic Hold

Principle

Automatic Hold provides assistance by automatically applying and releasing the brake, e.g., when driving off on inclines or in stop-and-go traffic.

When a gear position is engaged, the vehicle is automatically held in place when it is stationary.

General information

The parking brake is applied automatically by Automatic Hold under the following situations:

- If drive-ready state is turned off.
- The driver's door is open for more than one second and no pedal is pressed during this time.
- If the parking brake is used to brake the vehicle to a stop while driving.

In selector lever position N, Automatic Hold is temporarily deactivated.

Safety information

Warning

An unsecured vehicle can begin to move and possibly roll away. There is a risk of accident, injury, and property damage. Before leaving the vehicle, secure the vehicle against rolling away.

In order to ensure that the vehicle is secured against rolling away, follow the following:

- Set the parking brake.
- Automatic transmission: Make sure that selector lever position P is engaged.

- On uphill grades or on downhill slopes, turn the front wheels in the direction of the curb.
- On uphill grades or on downhill slopes, also secure the vehicle, for instance with a wheel chock.

Warning

Unattended children or animals in the vehicle can cause the vehicle to move and endanger themselves and traffic, for example, due to the following actions:

- Establishing standby.
- Releasing the parking brake.
- Opening and closing the doors or windows.
- Engaging selector lever position N.
- Using vehicle equipment.

There is a risk of accident, injury, and property damage. Do not leave children or animals unattended in the vehicle. Take the vehicle key with you when exiting and lock the vehicle.

Activating Automatic Hold

On the Interaction Unit

To activate Automatic Hold on the Interaction Unit, the vehicle must be at a standstill.

To activate, go through the menu as follows: Apps menu / "Vehicle" / "Driving settings" / "Drivetrain and chassis" / "Automatic Hold".



When Automatic Hold is activated, the indicator light for the parking brake illuminates green.



When driving, the indicator light changes from green to gray to show that Automatic Hold is ready.

Using the brake pedal

To activate Automatic Hold using the brake pedal, the vehicle must be at a standstill. Proceed as follows to activate:

1. Switch on drive-ready state.
2. Depress the brake pedal until some resistance is perceptible. Then depress the brake pedal firmly.



As soon as Automatic Hold is activated, the indicator light for the parking brake illuminates green and a Check Control message appears.



When driving, the indicator light changes from green to gray to show that Automatic Hold is ready.

Automatic Hold holding the vehicle

If Automatic Hold is activated and the driver's door is closed, the vehicle is automatically secured to prevent it from rolling away after stopping.



As soon as Automatic Hold secures the vehicle to prevent it from rolling away, the indicator light for the parking brake illuminates green.

Automatic parking brake application

The parking brake is automatically set if drive-ready state is switched off while the vehicle is being held by Automatic Hold or if the vehicle is exited.



The indicator light changes from green to red.

The parking brake is not set automatically if the drive-ready state was switched off while the vehicle was coasting. Automatic Hold is temporarily deactivated in this case.

Driving off

Press the accelerator pedal to drive off. The brake is released automatically and the indicator light of the parking brake is no longer illuminated.

The vehicle may roll back slightly when driving off, depending on the load and driving situation or when towing a trailer.

Use the parking brake as needed to prevent the vehicle from rolling back when driving off.

Deactivate Automatic Hold

On the Interaction Unit

To activate/deactivate Automatic Hold via the Interaction Unit, go through the menu as follows: Apps menu / "Vehicle" / "Driving settings" / "Drivetrain and chassis" / "Automatic Hold".

- The indicator light goes out.
- Automatic Hold is switched off.

If the vehicle is being held by Automatic Hold, also press the brake pedal when deactivating.

Deactivating via the brake pedal

To deactivate Automatic Hold using the brake pedal, the vehicle must be at a standstill:

1. Depress the brake pedal until some resistance is perceptible.
2. Then depress the brake pedal firmly.

The indicator light for the parking brake goes out and a Check Control message appears.

Automatic Hold is deactivated.





Displays

Vehicle features and options

This chapter describes model-specific equipment, systems, and functions that are currently available, or may become available in the future, even if they are not present in the vehicle.

Additional information:

Vehicle equipment, refer to page 8.

- Configured interval for displaying trip data.
-  Average energy consumption depending on the set interval.
-  Travel time depending on the configured interval.
-  Distance traveled depending on the configured interval.
-  Counter for energy recovery depending on the configured interval.

Trip data

Principle

The trip data display provides various information about the trip, e.g., average energy consumption or trip distance.

The values can be displayed and reset depending on different intervals.

Viewing trip data

The Interaction Unit can be used to view the trip data. There are several ways to view trip data:

- Go through the menu as follows: Apps menu / "Vehicle" / "Trip data".
- Tap the range value on the Interaction Unit.
- On the Interaction Unit, tap the odometer reading in the speedometer.

Additional information:

Speedometer, refer to page 151.

Display

The following trip data is displayed:

Current electrical consumption

The current electrical consumption display allows you to check the current energy consumption, e.g., to drive efficiently.

Average electrical consumption

The average electrical consumption is determined on the basis of various distances.

Adjusting the display of the trip data

The intervals for displaying trip data can be configured.

1. To go to the Trip Data menu: Apps menu / "Vehicle" / "Trip data".
2. Tap the interval button.
3. Select the desired setting:
 - "for this trip": the values are automatically reset approx. four hours after the vehicle has come to a standstill.
 - "since charging": the values are automatically reset after charging.

- "since factory": the values since the time of the factory delivery are displayed.
- "since individ.": the values since the last manual reset are displayed. The values can be reset at any time.

Resetting average values manually

The average trip data values can be reset manually. The following interval is activated and the average values are reset: "since individ."

Via the Interaction Unit:

1. Go through the menu as follows: Apps menu / "Vehicle" / "Trip data".
2.  Tap the button for resetting trip data.

MINI Head-up display

Principle

The Head-up display projects important information in the driver's field of view, for instance the speed. Information can be recorded without you having to look away from the road.

The Head-up display can be configured as necessary, e.g., adjust the brightness.

General information

Follow instructions for cleaning the Head-up display in the Vehicle Care chapter.

Additional information:

Caring for special components, refer to page [395](#).

Safety information

Warning

When extending and retracting the projection screen of the Head-up display, body parts can be jammed. There is a risk of injury. Make sure that the area of movement of the projection screen is clear when extending and retracting.

NOTICE

The Head-up display consists of sensitive components that can easily be scraped or damaged. There is a risk of property damage. Do not place any objects on the Head-up display, attach to system components or plug into the system. Do not move the moving parts manually.

Overview



The Head-up display is switched on.

Displayable information

The following information is displayed on the Head-up display:

- Speed.
- Navigation instructions.
- Check Control messages.
- Lists and messages.
- The driver assistance systems.



Some of this information is only displayed briefly as needed.

Turning the Head-up display on/off

When switching on, the projection screen of the Head-up display is extended. When switching off, the projection screen of the Head-up display is retracted again.

To turn the Head-up display on/off, go through the menu as follows: Apps menu / "Vehicle" / "Displays" / "Head-up display" / "Head-up display".

Settings

Individual settings can be entered for the Head-up display such as for the height, brightness or illustration. You can also set up specific views on the Head-up display separately, e.g., for Driver Assistance information.

1. Go through the menu as follows: Apps menu / "Vehicle" / "Displays" / "Head-up display".
2. Select the desired setting.

Depending on vehicle equipment, the height of the Head-up display can be stored using the memory function.

Visibility of the display

The visibility of the displays in the Head-up display is influenced by the following factors:

- Seat position.
- Dust or dirt on the projection screen of the Head-up display.
- Sunglasses with certain polarization filters.
- Wet road.
- Unfavorable light conditions.

Check Control

Principle

The Check Control system monitors functions in the vehicle and notifies you of faults in the monitored systems.

A Check Control message, combining indicator lights or warning lights and text, appears on the Interaction Unit and Head-up display, where applicable. In addition, an acoustic signal may sound.

Some Check Control messages are hidden automatically after approx. 20 seconds, but they will be stored. Stored Check Control messages can be displayed on the Interaction Unit. Urgent Check Control messages are permanently displayed but may be hidden temporarily.

Hiding Check Control messages

Permanently displayed Check Control messages can be hidden temporarily. These messages are automatically displayed again after approx. 8 seconds.

✕ The close icon next to the Check Control message indicates whether the Check Control message can be hidden.

Displaying stored Check Control messages

Saved Check Control messages and additional information such as the cause of a fault or the required action can be called up via Check Control.

Depending on the Check Control message, further help can be selected.

1. Go through the menu as follows: Apps menu / "Vehicle" / "Vehicle status" / "Check Control".
2. Select the desired text message.

Display

A Check Control message, consisting of text and an icon, is displayed. Additional instructions can be viewed by tapping on the text.

If several faults occur at once, the messages are displayed consecutively.

Certain messages displayed while driving are displayed again after drive-ready state is switched off.



Icons next to the menu bar indicate whether a Check Control message is active or saved.



Indicator lights and warning lights

Principle

The indicator lights and warning lights show the status of some vehicle functions or indicate when there is a fault in monitored systems.

Indicator lights and warning lights can illuminate in a variety of combinations and colors.

Some indicator lights are checked for proper functioning and illuminate temporarily when drive-ready state is turned on.

Red lights

Seat belt reminder



The seat belt on the driver's seat is not engaged.

Additional information:

Seat belt reminder, refer to page 111.

Airbag system



Warning light illuminates briefly: indicates that the entire airbag system and seat belt tensioners are operational when drive-ready state is switched on.

Warning light does not illuminate or illuminates continuously: The airbag system or seat belt tensioners may not be operational. Have the vehicle checked immediately by an authorized service center or another qualified service center or repair shop.

Additional information:

Airbags, refer to page 174.

Parking brake



The parking brake is set.

Additional information:

Parking brake, refer to page 137.

Brake system



The brake pads are worn or there is another issue with the brake system.



The braking assistance may not be operational. A higher pedal force may be required for braking.

Have the vehicle checked immediately by an authorized service center or another qualified service center or repair shop.

System fault



Contact an authorized service center or another qualified service center or repair shop.

Emergency Stop Assistant



The Emergency Stop Assistant is triggered.

Additional information:



Emergency Stop Assistant, refer to page 205.

Risk of collision



The warning light illuminates or flashes in conjunction with an acoustic signal if there is a risk of imminent collision.

Additional information:

Forward Collision Mitigation, refer to page 180.

Pedestrian Warning



The warning light illuminates: risk of collision with a person, e.g., a pedestrian or a cyclist detected. Increased awareness is required.

The warning light flashes and a signal sounds: risk of imminent collision with a person, e.g., a pedestrian or a cyclist detected. Immediately initiate braking or an evasive maneuver.

Additional information:

Warning function for pedestrians, refer to page 186.

Forward Collision Warning



The warning light illuminates: risk of collision, e.g., with a vehicle detected. Increased awareness is required.

The warning light flashes and a signal sounds: risk of imminent collision with a vehicle detected. Immediately initiate braking or an evasive maneuver.

Additional information:

Warning function in rear-end collision situations, refer to page 183.

Intersection Collision Warning: vehicle detected from the right



The warning light illuminates: risk of collision with a vehicle crossing from the right detected. Increased awareness is required.

The warning light flashes and a signal sounds: risk of imminent collision with a crossing vehicle detected. Immediately initiate braking or an evasive maneuver.

Additional information:

Warning function at intersections, refer to page 187.

Intersection Collision Warning: vehicle detected from the left



The warning light illuminates: risk of collision with a vehicle crossing from the left detected. Increased awareness is required.

The warning light flashes and a signal sounds: risk of imminent collision with a crossing vehicle detected. Immediately initiate braking or an evasive maneuver.

Additional information:

Warning function at intersections, refer to page 187.

Distance control



Warning light flashes and acoustic signal sounds: Brake and evade as necessary.

Additional information:

Distance Control, refer to page 228.

Assisted Driving Mode



Warning light flashes and signal sounds: The system is switched off or will be interrupted very soon.

Warning light illuminates and signal sounds: The driver is not looking at the

surrounding traffic. System interruption is imminent. The system reduces the speed to a standstill if applicable. It is possible that the system will not execute any supporting steering movements.

Additional information:

Assisted Driving Mode, refer to page [234](#).

Assisted Driving Mode: Hands are not on steering wheel



Warning light illuminates and acoustic signal sounds:

The hands are not on the steering wheel or, depending on the vehicle equipment and national-market version, the driver's line of sight is not directed at the surrounding traffic. System interruption is imminent.

The system reduces the speed to a standstill if applicable.

It is possible that the system will not execute any supporting steering movements.

Immediately grasp the steering wheel with your hands and pay attention to the surrounding traffic.

Additional information:

Assisted Driving Mode, refer to page [234](#).

Yellow lights

Antilock Braking System



The system may not be operational. The Antilock Braking System is not available.



The ability to steer may be restricted during full braking.

Have the vehicle checked immediately by an authorized service center or another qualified service center or repair shop.

Additional information:

Antilock Braking System, refer to page [216](#).

Assisted Driving Mode



Warning light illuminates and acoustic signal sounds: A system interruption is imminent.

Warning light flashes: A lane boundary has been crossed.

Additional information:

Assisted Driving Mode, refer to page [234](#).

Assisted Driving Mode: Hands are not on steering wheel



Steering wheel icon illuminates yellow: Do not grip the steering wheel with your hands. The system is still active.

Grab the steering wheel with your hands.

Additional information:

Assisted Driving Mode, refer to page [234](#).

Dynamic Stability Control



Warning light flashes: Dynamic Stability Control is regulating the driving and brake power. The vehicle is stabilized. Reduce the vehicle speed and adjust your driving style to the road conditions.

Warning light illuminates: Dynamic Stability Control has malfunctioned or is initializing. Driving stabilization is restricted or has failed.

If the warning light illuminates continuously, have the vehicle checked immediately by an authorized service center or another qualified service center or repair shop.

Additional information:

Dynamic Stability Control, refer to page [216](#).



Dynamic Stability Control deactivated, or increased driving dynamics activated



Dynamic Stability Control is deactivated or enhanced driving dynamics is activated.

Additional information:

- Dynamic Stability Control, refer to page 216.
- Setting for increased driving dynamics, refer to page 218.

Drive-off support



Drive-off support is activated.

Additional information:

Drive-off support, refer to page 219.

Flat tire monitor



Warning light illuminates: Flat Tire Monitor is indicating a flat tire or tire pressure loss.

Reduce your speed and stop cautiously. Avoid sudden braking and steering maneuvers.

Additional information:

Flat tire monitor, refer to page 366.

Tire pressure monitor



Warning light illuminates: Tire Pressure Monitor is indicating a flat tire or tire pressure loss. Follow the information in the Check Control message.

Warning light flashes then illuminates continuously: Flat tires or tire pressure losses cannot be detected.

- Fault caused by systems or devices with the same radio frequency: after leaving the area of the interference, the system automatically becomes active again.
- In the case of tires with special approval: the tire pressure monitor was un-

able to complete the reset. Reset the system again.

- Wheel without wheel electronics installed: Have it checked by an authorized service center or another qualified service center or repair shop as needed.
- Malfunction: have the vehicle checked by an authorized service center or another qualified service center or repair shop.

Additional information:

Tire pressure monitor, refer to page 359.

Steering system



The steering system may not be operational.

Have the vehicle checked by an authorized service center or another qualified service center or repair shop.

Acoustic pedestrian protection



Acoustic pedestrian protection has malfunctioned. Increased caution when maneuvering.

If malfunctioning repeatedly, have the vehicle checked by an authorized service center or another qualified service center or repair shop.

Additional information:

Acoustic pedestrian protection, refer to page 127.

Charging capacity limited



Additional information:

Charge vehicle, refer to page 332.



Green lights

Turn signal



The turn signal is turned on.

If the indicator light is flashing unusually fast, this indicates that a turn signal bulb has failed.

Additional information:

Turn signal, refer to page [160](#).

Parking lights



The parking lights are turned on.

Additional information:

Parking lights, low-beam headlights, refer to page [164](#).

Low-beam headlights



The low-beam headlights are turned on.

Additional information:

Parking lights, low-beam headlights, refer to page [164](#).

Automatic High Beam Assistant



Low-beam headlights are on and Automatic High Beam Assistant is enabled.

The high-beam headlights are turned on and off automatically depending on the traffic.

Additional information:

Automatic High Beam Assistant, refer to page [161](#).

Automatic Hold holding the vehicle



After stopping, the vehicle is automatically secured against rolling away as soon as the indicator light illuminates green.

Additional information:

Automatic Hold, refer to page [140](#).

Lane departure warning



Depending on vehicle equipment and national-market version:

Indicator light flashes: System is actively issuing a warning. If necessary, the system performs a steering intervention.

Additional information:

Lane departure warning, refer to page [191](#).

Cruise Control



The system is active.

Additional information:

Cruise control, refer to page [225](#).

Distance control



Indicator light illuminates: Vehicle has been detected ahead of you. The vehicle icon goes out if no vehicle has been detected ahead of you.

Indicator light flashes: Preceding vehicle has driven off.

Additional information:

Distance Control, refer to page [228](#).

Speed Limit Assistant



The detected speed limit can be applied with the SET button. As soon as the speed limit has been applied, a green checkmark is displayed.

Additional information:

Speed Limit Assistant, refer to page [245](#).

Assisted Driving Mode



The system supports the driver in keeping the vehicle within the lane.

Additional information:



Assisted Driving Mode, refer to page [234](#).

Lane Change Assistant: lane change in progress



Arrow icon for lane change green: the system carries out a lane change.

Additional information:

Lane Change Assistant, refer to page [239](#).

Lane Change Assistant: lane change not possible



Gray line for lane boundary on corresponding side: System has detected a lane change request. Lane change not currently possible.

Additional information:

Lane Change Assistant, refer to page [239](#).

Assisted Driving Mode Plus



The system is active.

Additional information:

Assisted Driving Mode Plus, refer to page [242](#).

Blue lights

High-beam headlights



High-beam headlights have been turned on.

Additional information:

High-beam headlights, refer to page [160](#).

Automatic High Beam Assistant



High-beam headlights have been turned on by the Automatic High Beam Assistant.

Additional information:

Automatic High Beam Assistant, refer to page [161](#).

Gray lights

Seat belt reminder



Seat belt on the passenger seat or another seat in the vehicle is not buckled.

Additional information:

Seat belts, refer to page [109](#).

Distance control



Indicator light flashes: The requirements to operate the system have not been met. The system was deactivated but applies the brakes until you actively resume control by pressing on the brake pedal or accelerator pedal.

Additional information:

Distance Control, refer to page [228](#).

Automatic Hold on standby



When driving, the indicator light shows that Automatic Hold is ready.

Additional information:

Automatic Hold, refer to page [140](#).

Assisted Driving Mode



The system is on standby and does not manipulate steering movements. System activates automatically as soon as all function conditions are fulfilled.

Additional information:

Assisted Driving Mode, refer to page [234](#).

White lights

Cruise Control with Distance Control



No Distance Control because accelerator pedal is being pressed.

Additional information:

Distance Control, refer to page [228](#).

Assisted Driving Mode Plus



The system can be used.

Additional information:

Assisted Driving Mode Plus, refer to page [242](#).

Speedometer

Principle

The speedometer provides detailed driving information next to the speed, e.g., mileage.

Overview

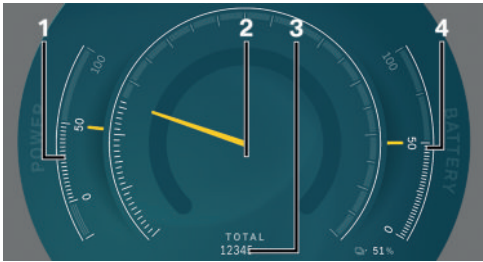

- 1 Power gauge [151](#)
- 2 Vehicle speed
- 3 Odometer reading [142](#)
- 4 State of charge indicator [155](#)

Displaying the speedometer

To display the speedometer, tap the speed value at the top of the Interaction Unit.

Power gauge

Principle

The power gauge indicates the current electric drive power as a percentage.

Display

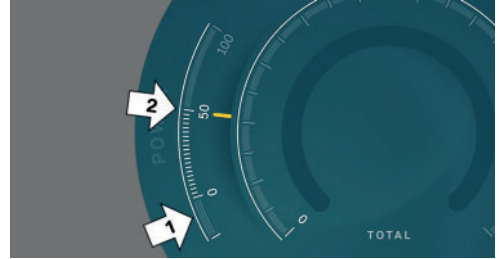



Needle in lower range, arrow 1: Indicator for energy recovery, e.g., while decelerating.



Needle in upper range, arrow 2: Drive power in percent.

Reduced drive power

The available drive power may be reduced due to certain factors. The power gauge is automatically adjusted accordingly.

In addition, the icons in the power gauge indicate a reduced drive power.

Icon	Description
	Blue icon: cold drivetrain.
	White icon: increased drive system temperature, for instance due to sustained or high power demand when driving on mountain roads.
	Depending on vehicle equipment and national-market version: Drive power restriction determined by MINI Digital Key.

Icon	Description
	Heavily discharged high-voltage battery.
	System-related functional limitation. A Check Control message is displayed in addition where applicable.

Energy recovery



Current energy recovery



The vehicle recovers energy in certain driving situations, e.g., braking. The amount of energy currently recovered is shown at the edge of the power gauge within the driving information.

Strength of recuperative braking

The set energy recovery level is shown next to the selector lever position indicator and on the speedometer next to the power gauge.

Icon	Meaning
	Low energy recovery. Selector lever position D is engaged.
	Average energy recovery. Selector lever position D is engaged.
	High energy recovery. Selector lever position D or B is set.

The degree of the energy recovery depends on the settings for the energy recovery.

Additional information:

Driving in detail, refer to page 131.

Standby state and drive-ready state



If OFF appears on the Interaction Unit, drive-ready state is turned off and standby state is turned on.



When drive-ready state is on, READY appears on the Interaction Unit.

Additional information:

- Operating state of the vehicle, refer to page 45.

Selection lists

Principle





The Interaction Unit or Head-up display provide lists of certain functions, which can be operated as necessary:

- Entertainment source.
- Current audio source.
- List of recent calls.
- Shortcuts list.

If necessary, the corresponding menu will open.

Displaying and using the list

The selection lists can be displayed and operated using the operating elements on the steering wheel.

Operating elements	Function
	Change the entertainment source. Pressing the button again will close the currently displayed list.
	Show list of most recent telephone calls.
	Displaying the list of shortcuts.
	Turn the knurled wheel: display the list for currently selected entertainment source or scroll up or down in the list. Tilt knurled wheel in corresponding direction: Move selection to left or right. Press knurled wheel: confirm selection.

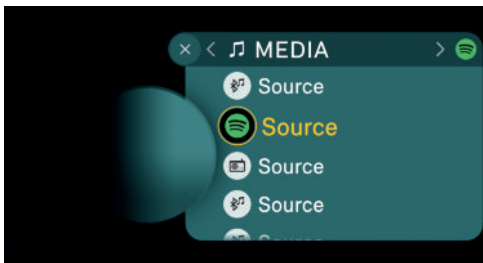

Additional information:
Shortcuts, refer to page 52.

Display





Selection lists, e.g., entertainment sources, are shown on the Head-up display or on the Interaction Unit, depending on vehicle equipment and settings.

Example: changing the entertainment source

-  To select an entertainment source, press the entertainment source button on the right of the steering wheel.
-  To select an entertainment source, turn the knurled wheel.
- Press the knurled wheel to confirm the selected entertainment source.

Example: selecting a radio station

-  To select a radio station, press the entertainment source button on the right of the steering wheel.
-  To switch to the radio stations list, tilt the knurled wheel to the right.
- Turn the knurled wheel to select a radio station.
- Press the knurled wheel to confirm the selected radio station.

Range

General information

The expected range for the energy stored in the high-voltage battery is continuously displayed on the Interaction Unit.

Always make sure that the range is sufficient for the planned trip. The range is dynamic and can abruptly change.

The range can be reduced or increased based on the following factors:

- Driving style.
- Traffic conditions.

- Drive mode change.
- Climate and terrain conditions.
- Automatic climate control settings.
- After determination of a route through the navigation system depending on the route profile, route distance and selected speed.
- When exiting a route or recalculating a route.
- By preheating/precooling the high-voltage battery for a DC charging process.

Information about the current range can be displayed on the Interaction Unit.

Check Control messages indicate a limited range.

Additional information:

- Increasing the range, refer to page 327.

Display

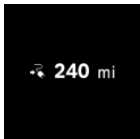

The current range is displayed as a numerical value next to the charge level indicator.

Range with active guidance

The icon is displayed next to the range when guidance was started in the navigation system. Information from the navigation system is taken into account for the calculation of the current range.

Heavily discharged high-voltage battery



The high-voltage battery is heavily discharged. The drive power will be reduced. Heating and climate control functions will be deactivated.

In this state, the exact range can no longer be calculated. A short range may still be

available depending on the environmental condition.

Re-establishing the drive-ready state can help increase the range slightly, for instance to remove the vehicle from a hazardous area.

State of charge in strong temperature fluctuations

In the case of strong temperature fluctuations and a low state of charge of the high-voltage battery, it may not be possible to start the vehicle again at the beginning of the next trip. Recharge vehicle with a low state of charge in time.

Range prediction

Principle

The range prediction indicates the extent to which the range can be influenced with the current driving style. This supports an efficient driving style.

General information

The current range is influenced by many factors, including speed.

The range trend shows the expected development of the range with the current driving style. The range trend is based on the average electrical consumption that is calculated for the directly traveled route section.

Additional information:

- Range, refer to page 153.
- Increasing the range, refer to page 327.

Overview

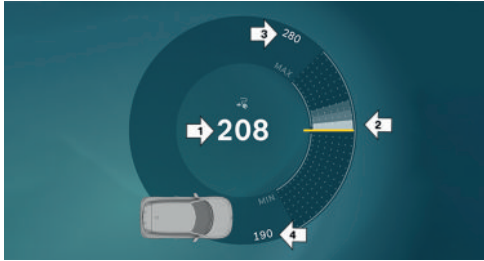



- Current range, arrow 1.
- Range trend, arrow 2.
- Possible range with very low energy consumption, arrow 3.
- Possible range with very high energy consumption, arrow 4.

Displaying the range prediction

To display the range prediction, go through the menu as follows: Apps menu / "All" / "Range prediction".

Range prediction with active guidance

With active guidance, the distance to the destination and the expected charge state of the high-voltage battery when the destination is reached are also displayed.

Icon	Description
	The expected battery charge state when the destination is reached is displayed next to the icon.
	The icon is displayed when route guidance to a charging post was started on the navigation system.
	The icon is displayed when route guidance was restarted on the navigation system. Information from the navigation system is taken into account for the calculation of the current range.

State of charge indicator

Safety information

Warning

Even when it is indicated that the high-voltage battery is discharged, the high-voltage system is always still under high voltage. There is a risk of fire or a risk of injury. Do not touch or change live parts, e.g., orange high-voltage cables, even when the batteries are discharged.

Display



When standby and drive-ready state are on, the available charge of the high-voltage battery is displayed continuously as a percentage.

An arrow next to the battery icon indicates the vehicle side on which the charging socket flap is located.

In case of temperature fluctuations, the battery charge state may change.

Vehicle status





General information

The status can be displayed and actions performed for several systems such as for Check Control.

Displaying vehicle status

To display the vehicle status, go through the menu as follows: Apps menu / "Vehicle" / "Vehicle status".

Overview

Icon	Description
	"Flat Tire Monitor": Status of the flat tire monitor, refer to page 366 .
	"Tire Pressure Monitor": status of the Tire Pressure Monitor, refer to page 359 .
	"Check Control": displaying stored Check Control messages, refer to page 144 .
	"Service": display of the service notifications, refer to page 159 .

Charging screen

Principle

The charging screen on the Interaction Unit provides charging information.

General information

Some views on the Interaction Unit may look different than they are depicted in the Owner's Manual.

When the vehicle is locked, the most important information is displayed for a short period of time.

To show the charging display again:



With the charging cable plugged in, press the button on the vehicle key.

Additional information:

Charge vehicle, refer to page [332](#).

Overview

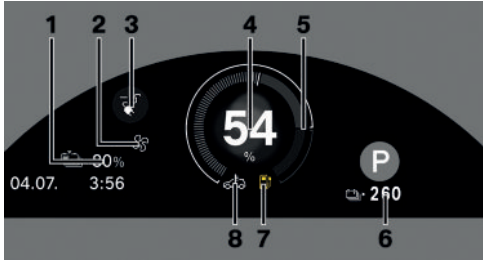

- 1 Charge target set [341](#)
End of charging time [342](#)
- 2 Departure air conditioning [344](#)
- 3 Unlocking the charging cable [334](#)
- 4 Current state of charge [342](#)
- 5 Charge target set [341](#)
- 6 Current range [342](#)
- 7 Restricted due to charging infrastructure [332](#)
- 8 Restricted due to temperature of high-voltage battery [332](#)

Assisted View

Principle

With Assisted View, information on driver assistance systems can be shown with the help of a vehicle animation.

Safety information

Warning

The system cannot serve as a substitute for the driver's personal judgment in assessing the traffic situation. Based on the limits of the system, it cannot independently react to all traffic situations. There is a risk of accident, injury, and property damage. Adjust driving style to traffic con-

ditions. Watch the surrounding traffic situation closely, be ready to take over steering and braking at any time, and actively intervene where appropriate.

Display



An example of active Driver Assistance: Indicator lights and warning lights for Distance Control and Assisted Driving Mode are displayed. At the same time, the Distance Control is animated in Assisted View.



Assisted View can also be activated for the Head-up display via Settings.

System limits

The system's detection capability is limited. Only objects that are detected by the system are taken into account.

Additional information:

- Cameras, refer to page [40](#).
- Radar sensors, refer to page [41](#).

Sport displays

Principle

The sport displays in the Live Vehicle menu provide assistance for a sporty driving style.



Display

The sport displays are shown in Go-Kart Mode of MINI Modes.

The following information is displayed:

- Torque.
- Power.
- Temperature, electric motor.
- Current electrical consumption.
- G-Meter.

Additional information:

MINI Modes, refer to page [135](#).

G-Meter

General information

The G-Meter indicates the forces that are applied in longitudinal and transverse direction on the vehicle occupants while driving.

The display can be configured in the widgets on the Interaction Unit.

The values are automatically reset whenever you start a new drive.

Additional information:

MINI Interaction Unit, refer to page [49](#).

Manually resetting G-Meter values

1. Display the G-Meter on the Interaction Unit.
2.  Press and hold the knurled wheel on the steering wheel until the values reset.

Outside temperature

General information

If the indicator drops to +37°F/+3°C or lower, a signal sounds.

A Check Control message is displayed.

There is an increased risk of ice on roads.

When the vehicle is stationary or at low speed, the temperature displayed may differ slightly from the actual outside temperature due to external environmental influences.

Safety information

Warning

Even at temperatures above +37 °F/+3 °C there is a risk of icy roads, for instance on bridges or shady sections of the road. There is a risk of accident, injury, and property damage. Modify your driving style to the weather conditions at low temperatures.

Date and time

Various settings can be configured for displaying the date and time.

Depending on vehicle equipment and national-market version, the time zone can be set manually or automatically. Automatic time zone adjustment automatically updates the time, date, and time zone as necessary.

The date is set automatically based on the time zone.

1. Go through the menu as follows: Apps menu / "Vehicle" / "System settings" / "Time".
2. Select the desired settings.

Setting the units of measurement

Depending on the national-market version, you can set the units of measurement for some values, for instance energy consumption, distances, and temperature.

1. Go through the menu as follows: Apps menu / "Vehicle" / "System settings" / "Units".
2. Select the desired setting.

Service

Principle

The service notifications indicate recommended maintenance work.

General information

After switching on the vehicle, the Interaction Unit briefly shows the next service appointment or the distance remaining until the next required maintenance.

A service advisor can read out the maintenance work from the vehicle key.

Display

More detailed information can be displayed.

1. Go through the menu as follows: Apps menu / "Vehicle" / "Vehicle status" / "Service".
Maintenance measures as well as legally mandated inspections are displayed.
2. Select the desired entry to bring up more information.

Entering appointment dates

The dates for mandatory vehicle inspections can be entered.

Make sure that the vehicle's date and time are set correctly.

1. Go through the menu as follows: Apps menu / "Vehicle" / "Vehicle status" / "Service" / "Vehicle inspection".
2. Select the desired setting.



Light and view

Vehicle features and options

This chapter describes model-specific equipment, systems, and functions that are currently available, or may become available in the future, even if they are not present in the vehicle.

Additional information:

Vehicle equipment, refer to page 8.

Turn signal

Principle

The turn signal indicates the change in your direction of travel. To indicate a turn, the following functions can be used:

- Flashing.
- One-touch signaling.
- Brief flashing.

Turn signal in exterior mirror

To ensure that the turn signal lamps on the exterior mirror are clearly visible, do not fold in the exterior mirrors while driving and while using the turn signals or hazard warning system.

Flashing

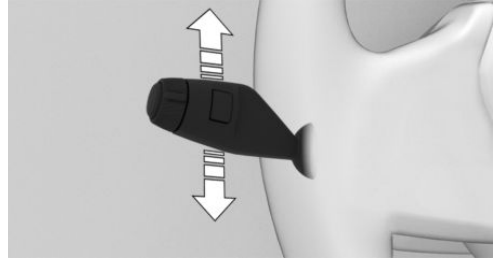

To flash the turn signal, push the turn signal lever up or down past the resistance point.

One-touch signaling

For one-touch signaling: Lightly tap the turn signal lever up or down.

The one-touch signaling duration can be adjusted.

1. Go through the menu as follows: Apps menu / "Vehicle" / "Exterior lighting" / or "Settings" / "One-touch turn signal".
2. Select the desired setting.

Brief flashing

To flash the turn signal briefly: Push the turn signal lever to the resistance point and hold it there for as long as you wish to indicate a turn.

High-beam headlights, headlight flasher

Principle

The high-beam headlights illuminate the road, also at great distances. The headlight flasher is used to emit a brief light signal

by actuating the high-beam headlights. The high-beam headlights can be switched on and off manually at any time.

High-beam headlights, turning headlight flasher on/off

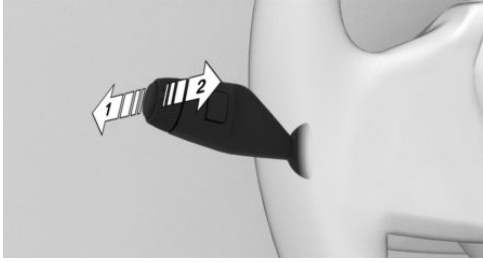

To turn on the high-beam headlights, push the turn signal lever forward, arrow 1. The high-beam headlights illuminate when the low-beam headlights are switched on.

To turn off the high-beam headlights or operate the headlight flasher, pull the turn signal lever backward, arrow 2.



The blue indicator light on the Interaction Unit illuminates when the high-beam headlights or headlight flasher are turned on.

Automatic High Beam Assistant

Principle

The Automatic High Beam Assistant promptly detects other road users as well as the ambient lighting, e.g., in towns, and automatically switches the high-beam headlights on or off depending on the traffic situation.

It may be necessary to activate the Automatic High Beam Assistant via the Interaction Unit before it can be used. You can use the turn signal lever to temporarily deacti-

vate or activate the Automatic High Beam Assistant, e.g., after turning your high-beam headlights on/off manually.

General information

In the low speed range, the high-beam headlights are not switched on by the Automatic High Beam Assistant.

Functional requirements

The following functional requirements apply to the Automatic High Beam Assistant:

- The automatic lights function is activated.
- The low-beam headlights are turned on.

Activating Automatic High Beam Assistant

The Automatic High Beam Assistant can be activated using the Interaction Unit.

1. Go through the menu as follows: Apps menu / "Vehicle" / "Exterior lighting" / "Headlights".
2.  Tap the High Beam Assistant button.

The headlights are automatically changed between low-beam headlights and high-beam headlights.



The green indicator light on the Interaction Unit illuminates when the low-beam headlights are turned on.



The blue indicator light on the Interaction Unit illuminates when the system turns on the high-beam headlights.

If the Automatic High Beam Assistant is on and you continue driving after an interruption, the Automatic High Beam Assistant will remain on.



The Automatic High Beam Assistant is deactivated when manually switching the high-beam headlights on and off.

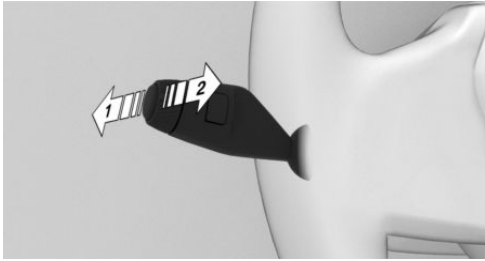

To reactivate the Automatic High Beam Assistant, press the turn signal lever up, arrow 1.

Deactivating Automatic High Beam Assistant

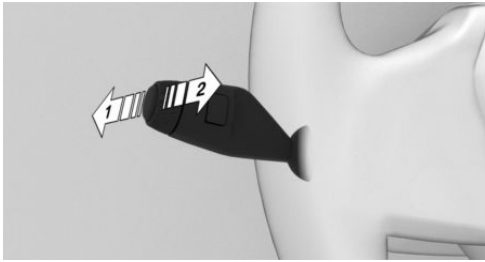

Press the turn signal lever forward, arrow 1, or pull the turn signal lever backward when the high-beam headlights are on, arrow 2.

When the Automatic High Beam Assistant is deactivated via the Interaction Unit, the high-beam headlights cannot be operated using the turn signal lever.

Sensitivity of the Automatic High Beam Assistant

General information

The sensitivity of the Automatic High Beam Assistant can be adjusted.

Safety information

Warning

If adjustments have been made or the sensitivity has been modified, oncoming traffic may be momentarily blinded. There is a risk of accident, injury, and property damage. If adjustments have been made and the sensitivity has been modified, make sure that oncoming traffic is not momentarily blinded. Switch off the high-beam headlights manually if required.

Functional requirements

The following functional requirements apply when adjusting the sensitivity of the Automatic High Beam Assistant:

- Adjustment is possible only while your vehicle is stationary.
- Drive-ready state is switched on.
- The light is switched off.

Increasing sensitivity

To increase the sensitivity of the Automatic High Beam Assistant, push the turn signal lever forward for approx. 10 seconds.

A Check Control message is displayed. The system responds more sensitively.

Resetting the sensitivity

To reset the sensitivity of the Automatic High Beam Assistant, push the turn signal lever forward again for approx. 10 seconds or switch off drive-ready state.

The sensitivity of the Automatic High Beam Assistant is reset to the factory settings.

System limits

The Automatic High Beam Assistant cannot replace the driver's personal judgment of when to use the high-beam headlights.

Therefore, when appropriate, turn off the high-beam headlights manually.

The system may not be fully operational in the following situations, and driver intervention may be necessary:

- In very unfavorable weather conditions such as fog or heavy precipitation.
- When detecting poorly-lit road users such as pedestrians, cyclists, horseback riders and wagons; when driving close to train or ship traffic; or at animal crossings.
- In tight curves, on hilltops or in depressions, in crossing traffic or half-obscured oncoming traffic on highways.
- In poorly-lit towns and cities or in the presence of highly reflective signs.
- When the windshield in the area in front of the interior mirror is fogged up, dirty or covered with stickers, etc.

Exterior lighting

Principle

The exterior lighting comprises all lighting elements on the outside of the vehicle. The exterior lighting, or individual functions of it, can be operated using the buttons in the vehicle or on the vehicle key, or via the Interactive Unit.



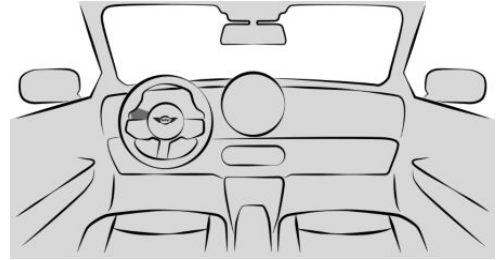

If the driver's door is opened when the drive-ready state is switched off, the exterior lighting is automatically switched off after a period of time.

Overview



Buttons in the vehicle



The exterior lighting switch and buttons are located on the turn signal lever, to the left of the steering wheel.

Icon	Function
	Exterior lighting menu.
	Low-beam headlights.
	Automatic headlight control.
	Exterior lighting off.

Functions via the Interaction Unit

Icon	Function
	Automatic headlight control.
	Low-beam headlights.
	Exterior lighting off.



Icon	Function
	Automatic High Beam Assistant.
	Parking lights.
	Left roadside parking light.
	Right roadside parking light.

Buttons on the vehicle key

Icon	Function
	Interior lighting. Parts of the exterior lighting.
	Pathway lighting.

Driving lights automatic

Principle

The automatic lights function switches the low-beam headlights on or off automatically depending on the ambient brightness, e.g., in tunnels, at dusk, or with precipitation.

General information

A blue sky with the sun low on the horizon can cause the lights to be turned on.

The automatic lights function is deactivated if you turn on the low-beam headlights manually.

Activate automatic headlight control



To activate the automatic lights, turn the outer switch on the turn signal lever downward.

The LED under the automatic lights icon illuminates.



The green indicator light on the Interaction Unit illuminates when the low-beam headlights are turned on.

System limits

The automatic headlight control cannot replace your personal judgment of lighting conditions.

For example, the sensors are unable to detect fog or hazy weather. In these situations, turn the lights on manually.

Low-beam headlights, parking light, and roadside parking light

Principle

The low-beam headlights are used to illuminate the road without dazzling oncoming traffic. The parking lights and roadside parking lights are used to illuminate the vehicle when stationary. These functions can be operated using the buttons in the vehicle or via the Interaction Unit.

Low-beam headlights

Turning on low-beam headlights



To turn on the low-beam headlights, turn the outer switch on the turn signal lever upward.

The low-beam headlights illuminate when drive-ready state is switched on.



The green indicator light on the Interaction Unit illuminates when the low-beam headlights are turned on.

To turn on the low-beam headlights even when standby state is switched on, turn the outer switch on the turn signal lever upward again.

Turning off low-beam headlights

Depending on the national-market version, the low-beam headlights can be turned off in the low speed range:

-  Press the OFF button on the turn signal lever.
- Turn off the light via the Interaction Unit.

Parking lights

General information

The parking lights can only be turned on at low speeds.

Turning on parking lights

1. Go through the menu as follows: Apps menu / "Vehicle" / "Exterior lighting" / "Parking lights".
2.  Tap the parking lights button.



The green indicator light on the Interaction Unit illuminates when the parking light is turned on.

The vehicle is illuminated on all sides.

Do not use the parking lights for extended periods; otherwise, they might drain the vehicle battery and it would then be impossible to switch on drive-ready state.

Turning off parking lights

The following options are available to turn off the parking lights:

-  Press the OFF button on the turn signal lever.
- Turn off the light via the Interaction Unit.
- Switch on drive-ready state.

When drive-ready state is turned on, the automatic driving lights activate.

Roadside parking lights

When the vehicle is parked, a one-sided roadside parking light can be switched on.

1. Go through the menu as follows: Apps menu / "Vehicle" / "Exterior lighting" / "Parking lights".
2.  Tap the roadside parking light button for the desired side of the vehicle.

Welcome lights

Principle

The welcome light turns on automatically for a limited period of time when approaching or unlocking the vehicle.

Depending on the equipment, the exterior lighting of the vehicle can be set individually.



Activating/deactivating welcome light

The welcome light can be activated or deactivated.

1. Go through the menu as follows: Apps menu / "Vehicle" / "Exterior lighting" / "Settings".
2. Select the desired setting, depending on vehicle equipment:
 - "Welcome and goodbye"
When unlocking the vehicle, individual lighting functions are turned on.

Turning on the welcome light

You can turn on the welcome light as follows:

- Automatic activation when approaching.
- Activation when unlocking vehicle.



- With the vehicle locked, press the lock button on the vehicle key.
Depending on the settings, the interior lighting and parts of the exterior lighting will be turned on.
The function is not available for the first 10 seconds after locking.

Pathway lighting

Principle

For the pathway lighting, the exterior lighting that illuminates the vehicle's surroundings turns on for a certain period of time after leaving the vehicle.

Switching pathway lighting on

You can turn on the pathway lighting as follows:

- After switching off the drive-ready state, briefly push the turn signal lever forward.



- On the vehicle key, press and hold the panic alarm button for approx. 1 second.

Setting the duration

You can configure the duration of pathway lighting.

1. Go through the menu as follows: Apps menu / "Vehicle" / "Exterior lighting" / "Settings" / "Pathway lighting".
2. Select the desired setting.

Daytime driving lights

Principle

The daytime driving lights are used to ensure that the vehicle is more visible, e.g., in areas with sharply changing light conditions.

The daytime driving lights illuminate when drive-ready state is switched on.

Activating/deactivating daytime driving lights

In some countries, daytime driving lights are mandatory, so it may not be possible to deactivate the daytime driving lights in front.

1. Go through the menu as follows: Apps menu / "Vehicle" / "Exterior lighting" / "Settings".
2. Depending on vehicle equipment or national-market version, select the desired setting:
 - "Daytime driving lights"
 - "Rear daytime driving lights"

Adaptive lighting functions

Principle

The adaptive lighting functions provide dynamic illumination of the road.

The adaptive lighting functions may consist of one system or multiple systems, depending on the equipment version:

- Cornering light.

Activating the adaptive lighting functions

 To activate the adaptive lighting functions, turn the outer switch on the turn signal lever downward.

The LED on the turn signal lever illuminates.

The adaptive lighting functions are active when the drive-ready state is switched on.

Cornering light

In tight curves, for instance on mountainous roads or when turning, an additional cornering light is switched on that illuminates the inside of the curve when the vehicle is moving below a certain speed.

The cornering light is automatically switched on depending on the steering-wheel angle or, where applicable, the use of turn signals. When driving in reverse, the cornering lights may be automatically switched on regardless of the steering-wheel angle.

Adaptive headlight range control

The Adaptive Headlight Range Control compensates for vehicle acceleration, braking, and load conditions to prevent your headlights from dazzling oncoming traffic.

Automatic lights mode

Principle

With automatic lights mode, the appearance of the front and rear lights can be customized via the Interaction Unit.

Selecting automatic lights mode

1. To select automatic lights mode, go through the menu as follows: Apps menu / "Vehicle" / "Exterior lighting" / "Settings" / "Driving light mode".
2. Select the desired mode.

Instrument lighting

Principle

The instrument lighting illuminates switches and buttons with the individually set brightness.

The brightness of the instrument lighting can only be adjusted in darkness and when the parking lights or low-beam headlights are turned on.

Setting the brightness

The brightness of the instrument lighting can be adjusted.

1. Go through the menu as follows: Apps menu / "Vehicle" / "Interior lighting" / "Cockpit brightness".
2. Select the desired setting.

Interior lighting

Principle

The interior lighting comprises all lighting elements inside the vehicle. Depending on vehicle equipment, the interior lights, foot-well lights, entry lights, and ambient lights are controlled automatically.

Overview



The interior lighting menu button is located in the headliner.



The buttons for reading lights are located in the headliner.



The interior light button is located in the headliner.

Turning interior lights on/off

The interior lights can be turned on/off using the button in the headliner.



Press the interior light button in the headliner.

To turn off the interior light permanently, press and hold the button for approx. 3 seconds.

The interior lights in the rear of the vehicle can be switched on and off independently. The button is located in the rear headliner.

The interior lights can be turned on/off using the Interaction Unit.

1. Go through the menu as follows: Apps menu / "Vehicle" / "Interior lighting" / "Reading light".
2.  Select the interior lights icon.

Turning reading lights on/off

The reading lights can be turned on/off using the button in the headliner.



In the headliner, press the desired reading light button.

Depending on the vehicle equipment, the reading lights are located next to the interior lights in the front and rear.

The reading lights can also be turned on/off using the Interaction Unit.

1. Go through the menu as follows: Apps menu / "Vehicle" / "Interior lighting" / "Reading light".
2.  Select the icon for the desired seat reading light.

The brightness of the reading lights can be adjusted when they are turned on.

Changing settings

Depending on vehicle equipment, the brightness can be individually adjusted for specific seats.

1. Go through the menu as follows: Apps menu / "Vehicle" / "Interior lighting" / "Reading light".
2. Tap the desired seat.
3. Select the desired settings.

Ambient light

Principle

The ambient light comprises several light elements that provide diffuse light in the vehicle interior. Depending on the vehicle equipment, the Interaction Unit can be used to adjust the lighting level for some lights.

Activating/deactivating ambient light

To activate/deactivate the ambient light, go through the menu as follows: Apps menu / "Vehicle" / "Interior lighting" / "Ambient lighting" / "Ambient lighting".

Turning ambient light on/off



The ambient light is switched on when the vehicle is unlocked, and switched off when the vehicle is locked.

If the ambient light was disabled using the Interaction Unit, it will not turn on when the vehicle is unlocked.

Selecting the color

Depending on national-market version, the color of the ambient light can be selected in Personal Mode or Core Mode.

To select the color in Personal Mode, proceed as follows:

1.  On the switch cluster, select Personal Mode using the MINI Modes switch.
2.  Tap the Settings icon on the Interaction Unit.
3. Select the desired setting.

To select the color in Timeless Mode, proceed as follows:

1.  On the switch cluster, select Timeless Mode using the MINI Modes switch.
2. Go through the menu as follows: Apps menu / "Vehicle" / "Interior lighting" / "Ambient lighting".
3. Select the desired setting.

Setting the brightness

The brightness of the ambient light can be adjusted.

1. Go through the menu as follows: Apps menu / "Vehicle" / "Interior lighting" / "Ambient lighting".
2. "Background light" or "Light projection"
3. Select the desired setting.

The light graphic is turned off in Green Mode.

Dynamic light

With Dynamic Light, certain things, e.g., obstacles detected when opening doors, are indicated by light effects. If the ambient

light is disabled, the light effects are still displayed.

1. Go through the menu as follows: Apps menu / "Vehicle" / "Interior lighting" / "Ambient lighting" / "Lighting effects".
2. Select the desired setting.

Reduced lighting when driving at night

Some lights of the interior lighting are reduced when the vehicle is driven in the dark.

To activate/deactivate this function, go through the menu as follows: Apps menu / "Vehicle" / "Interior lighting" / "Ambient lighting" / "Reduced for night driving".

Window wiper system

Principle

The wiper system makes sure that you have a clear view, e.g., in the rain. It is operated using the wiper lever on the steering wheel.

Safety information

Warning

If the wipers start moving in the folded away state, body parts can be jammed or damage may occur to parts of the vehicle. There is a risk of injury and risk of property damage. Make sure that the vehicle is switched off when the wipers are in the folded-away state and the wipers are folded in when switching on.

NOTICE

The wiper blades can wear out or become damaged prematurely when wiping on a dry window for a longer period of time. The wiper motor can overheat. There is a risk of property damage. Do not use the wipers when the window is dry.

NOTICE

If the wipers are frozen to the windshield, the wiper blades can be torn off and the wiper motor can overheat when switching on. There is a risk of property damage. Defrost the windshield prior to switching the wipers on.

Turning on window wiper system

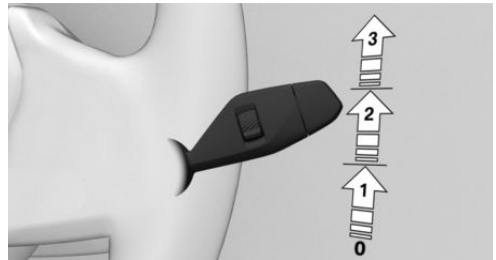

To turn on the wiper system, push the wiper lever upward to the desired position.

Position	Function
Position 0.	Rest position of wipers.
Position 1.	Rain sensor mode.
Position 2.	Normal wiper speed.
Position 3.	Fast wiper speed.

When you continue driving after stopping with the window wiper system on, the wipers will operate at the previous setting.

Turning off the window wiper system and flick wipe

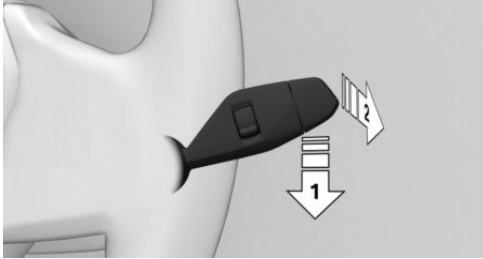

To turn off the wipers or to activate flick wiping, proceed as follows:

- To turn off: Push the wiper lever downward, arrow 1, until position 0 is reached.
- To flick wipe: Push the wiper lever downward from position 0, arrow 1, and push the wiper lever forward to position 0 or position 1, arrow 2.

The wiper lever returns to its initial position when released.

Rain sensor

Principle

The rain sensor automatically controls the wiper operation depending on the intensity of the rainfall. The sensor is located on the windshield, directly in front of the interior mirror.

Safety information

NOTICE

If the rain sensor is activated, the wipers can accidentally start moving in car washes. There is a risk of property damage. Deactivate the rain sensor in car washes.

Activating rain sensor

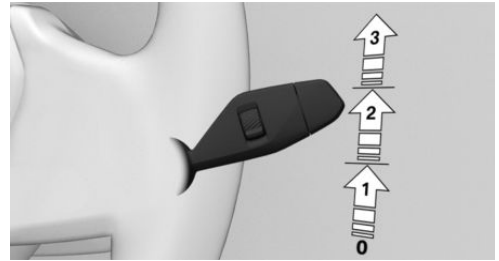

To activate the rain sensor: Push the wiper lever upward from position 0, arrow 1, once.

Wiping operation is started.

The LED in the wiper lever is illuminated. In frosty conditions, wiping operation may not start.

Deactivating rain sensor

To deactivate the rain sensor: Push the wiper lever back to position 0.

Adjusting the rain sensor sensitivity

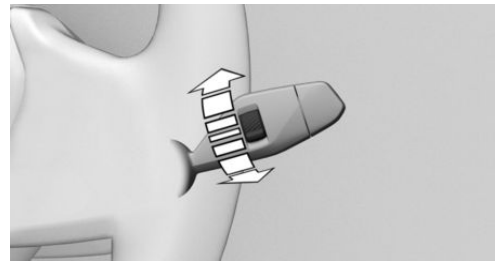

To adjust the sensitivity of the rain sensor, turn the knurled wheel on the wiper lever as follows:

- To set the rain sensor sensitivity to high, turn the knurled wheel up.
- To set the rain sensor sensitivity to low, turn the knurled wheel down.

Window washer system

Safety information

Warning

The washer fluid can freeze onto the window at low temperatures and obstruct the view. There is a risk of accident, injury, and property damage. Only use the window washer system when the washer fluid will not freeze. Use washer fluid with anti-freeze, if needed.

NOTICE

When the washer fluid reservoir is empty, the washer pump cannot work as intended. There is a risk of property damage. Do not use the washer system when the washer fluid reservoir is empty.

Cleaning the windshield

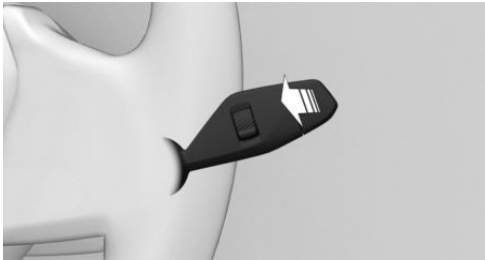

To clean the windshield, pull the wiper lever back.

The washer fluid is sprayed on the windshield, and the wipers are turned on briefly.

Windshield washer nozzles

The windshield washer nozzles are automatically heated while standby state is switched on.

Rear wiper

Switching on the rear wiper

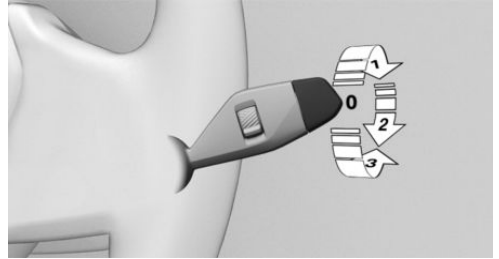

To turn on the rear wiper, rotate the outer switch on the wiper lever upward.

Switch position	Function
Position 0.	Rest position of the wiper.
Position 1.	Intermittent operation. When reverse gear is engaged, the system switches to continuous operation.

Clean the rear window

To clean the rear window, turn the outer switch on the wiper lever as follows:

- In rest position: Turn the switch downward, arrow 3. The switch returns to its rest position when released.
- In intermittent operation: Turn the switch further, arrow 2. The switch automatically returns to its interval position when released.

The function is deactivated if the washer fluid reservoir fill level is low.

Fold-out position of the wipers

Principle

In the fold-out position, the wipers can be folded out from the windshield, which

is important, for instance, when changing the wiper blades or for folding away under frosty conditions.

Safety information

Warning

If the wipers start moving in the folded away state, body parts can be jammed or damage may occur to parts of the vehicle. There is a risk of injury and risk of property damage. Make sure that the vehicle is switched off when the wipers are in the folded-away state and the wipers are folded in when switching on.

NOTICE

If the wipers are frozen to the windshield, the wiper blades can be torn off and the wiper motor can overheat when switching on. There is a risk of property damage. Defrost the windshield prior to switching the wipers on.

Folding out the wipers

To fold the wipers away from the windshield, proceed as follows:

1. Activate standby state.
2. Push the wiper lever down or forward and hold it until the wipers stop in an approximately vertical position.

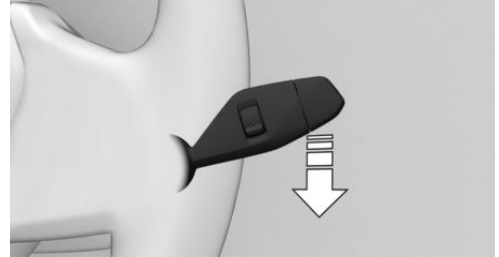

3. Fold the wipers all the way out from the windshield.



Folding in the wipers

To fold in the wipers, proceed as follows:

1. Fold the wipers back in toward the windshield.
2. Turn on standby state, then press the wiper lever down or forward again and hold it.

The wipers return to their rest position and are ready for operation.

Safety

Vehicle features and options

This chapter describes model-specific equipment, systems, and functions that are currently available, or may become available in the future, even if they are not present in the vehicle.

Additional information:

Vehicle equipment, refer to page 8.

Airbags

Principle

The airbag system provides additional protection in the event of an accident, especially if the seat belt is worn correctly.

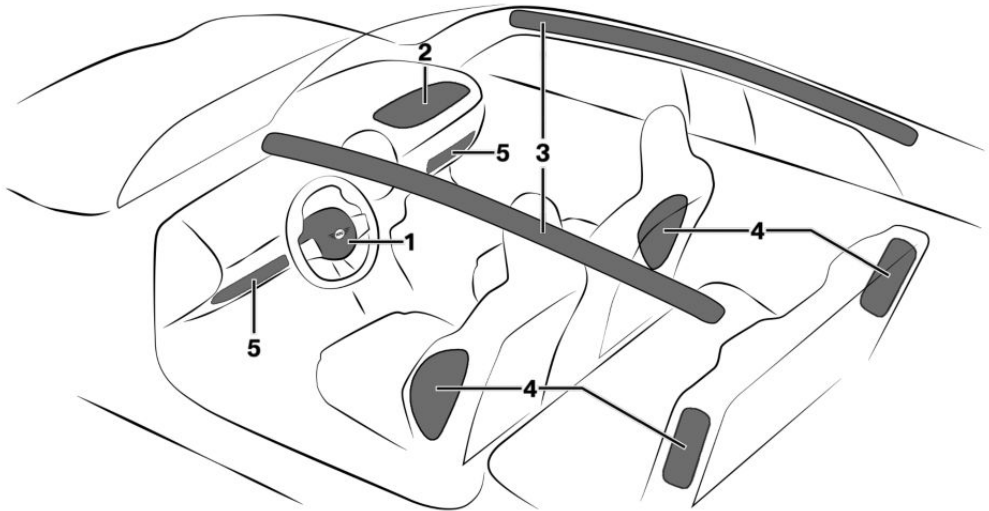

- | | |
|---------------------------------|---------------|
| 1 Front airbag, driver | 4 Side airbag |
| 2 Front airbag, front passenger | 5 Knee airbag |
| 3 Head airbag | |

Front airbags

The front airbag helps protect the driver and front passenger in the event of a frontal impact in which the seat belts alone would not provide adequate protection.

Side airbag

In the event of a side collision, the side airbag protects the side of the body in the chest and lap area.

The availability of the side airbag in the rear depends on the national-market version.

In the event of a side collision, the side airbag in the rear protects the chest and lap area on the side of the bodies of the occupants in the outer rear seats.

Head airbag

In the event of a side collision, the head airbag protects the head.

Ejection Mitigation

The head airbag system is designed as an ejection mitigation countermeasure to reduce the likelihood of ejections of vehicle occupants through side windows during rollovers or side collision events.

Knee airbag

The availability of the knee airbag depends on the national-market version.

The knee airbag protects the legs in the event of a frontal impact.

Protective effect

General information

Airbags are not deployed in every impact situation, e.g., in less severe accidents.

Information on optimum protective effect of the airbags

Warning

If the seat position is incorrect, the seat belts are fastened incorrectly or the deployment area of the airbags is impaired, the airbag system cannot provide protection as intended and may cause additional injuries due to deployment. There is a risk of injury or danger to life. Follow the information on achieving the optimum protective effect of the airbag system.

To ensure that the airbag system has the optimal protective effect, note the following:

- Keep a distance from the airbags.
- Fasten seat belts correctly.
- Always grasp the steering wheel on the steering wheel rim. Hold hands at the 3 o'clock and 9 o'clock positions to keep the risk of injuring hands or arms as low as possible when the airbag deploys.
- Adjust seat and steering wheel so that hands can cross over the steering wheel. Select the settings so that the shoulder rests against the backrest when crossing the hands and the upper body is as far back as possible while still maintaining a comfortable grip on the steering wheel.
- Make sure that the front passenger is sitting correctly, i.e., with their feet and legs in the footwell, not resting on the dashboard.
- Make sure that occupants keep their heads away from the side airbag.
- There should be no additional persons, animals or objects between an airbag and a person.
- Keep the dashboard and windshield on the passenger's side clear, i.e., do not cover with adhesive film or other coating, and do not attach mounts for, e.g., navigation devices or mobile phones.
- Do not bond the airbag cover panels with adhesive, do not cover them, and do not modify them in any way.
- Do not use the front passenger's side airbag cover for storage.
- Keep storage compartments near the airbags closed, e.g., glove compartment or center armrest.
- Do not place slip covers, seat cushions, or other objects on the front seats un-



less they are specifically designed for seats with integrated airbags.

- Do not hang pieces of clothing such as jackets over the backrests.
- Do not modify individual components or wiring. This also applies to the dashboard, steering wheel covers, and seats.
- Do not disassemble the airbag system.

Even when you follow all instructions very closely, injury from contact with the airbags cannot be fully ruled out in certain situations.

The ignition and inflation noise may lead to short-term and, in most cases, temporary hearing impairment in sensitive occupants.

Vehicle modifications for a person with disabilities may affect the air bag system; contact MINI Customer Relations for further information.

Warnings and information on the airbags are also found on the sun visors.

Operational readiness of the airbag system

Safety information

Warning

Individual components can be hot after deployment of the airbag system. There is a risk of injury. Do not touch individual components.

Warning

Improperly executed work can lead to failure, malfunction or unintentional deployment of the airbag system. In the case of a malfunction, the airbag system might not deploy as intended despite the accident severity. There is a risk of injury or danger to life. Have the airbag system checked,

repaired, disassembled, and scrapped by an authorized service center or another qualified service center or repair shop.

Interaction Unit view



The airbag system warning light on the Interaction Unit illuminates briefly when drive-ready state is turned on, thus indicating the operational readiness of the entire airbag system and seat belt tensioners.

Malfunction



- The airbag system warning light on the Interaction Unit does not illuminate when drive-ready state is turned on.
- The airbag system warning light on the Interaction Unit illuminates continuously.

The airbag system or the seat belt tensioners may not be operational. Have the vehicle checked immediately by an authorized service center or another qualified service center or repair shop.

Setting the front seat positions

The power that deploys the driver's/front passenger airbags depends on the position of the driver's/front passenger seat.

To maintain the accuracy of this function, calibrate the electrical front seats as soon as the respective message appears on the Interaction Unit.

Additional information:

Seats, refer to page [104](#).

Deactivating the front passenger airbag automatically

Principle

The automatic front passenger airbag deactivation system can detect if the front passenger seat is occupied.

The front passenger airbag is activated or deactivated accordingly.

Safety information

Warning

To ensure the front passenger airbag function, the system must be able to detect whether a person is sitting in the front passenger seat. The entire seat surface must be used for this purpose. There is a risk of injury or danger to life. Make sure that the front passenger keeps his or her feet in the footwell.

Functional requirements

To ensure that occupants on the front passenger seat are detected properly, the following functional requirements apply:

- Do not attach covers, cushions, ball mats or other items to the front passenger seat unless they are specifically determined to be safe for use on the front passenger seat.
- Do not place objects under the seat that can press against the seat from below.
- Sit upright in the seat with the back against the backrest.
- Sit down with your feet touching the floor.

Installing child restraint systems

To ensure that occupants on the front passenger seat are detected properly, note the following:

- Pay attention to the specifications and the operating and safety information of the child restraint system manufacturer when using child restraint systems.
- Make sure that the seat surface of the child restraint system rests as flat as possible on the seat surface.
- Move the head restraint up or remove it to ensure that the child restraint system rests as flat as possible against the rear seat backrest.
- Observe the maximum size of the child restraint system, for example to avoid possible touching the roof.

Before transporting a child on the front passenger seat, refer to the safety information and instructions for children on the front passenger seat, see Children.

Additional information:

Install child restraint systems, refer to page 121.

Indicator light, front passenger airbag

The front passenger airbag indicator light in the headliner indicates the operating state of the front passenger airbag.

The indicator light shows whether the airbag is activated or deactivated.

After drive-ready state is turned on, the indicator light illuminates briefly and then shows whether the airbag is activated or deactivated.



Display	Function
	<p>The indicator light is continuously illuminated when the seat is not occupied or when a child is detected on the seat in a provided child restraint system as intended. The airbag on the front passenger's side is not activated.</p> <p>The indicator light does not illuminate when, for instance, a correctly seated person of sufficient size is detected on the seat. The airbag on the front passenger's side is activated.</p>

When the front passenger seat is occupied, check the indicator light in the headliner before and while driving.

Fault of the automatic deactivation system

For adolescents and adults, the front passenger airbag may deactivate in certain seat positions. In this case, the indicator light for the front passenger airbag illuminates in the headliner.

In this case, change the seat position so that the front passenger airbag activates and the indicator light goes out.

If it is not possible to activate the airbags, have the person sit in the rear seat.

Occupancy detection

The occupant detection system satisfies the legal requirements of Federal Motor Vehicle Safety Standard FMVSS 208 and deactivates the front passenger airbag under certain conditions.

Collision warning systems

Principle

The Intelligent Safety systems can help prevent an impending collision. To do so, the area around the vehicle is monitored by various sensors.

Depending on vehicle equipment, various safety and warning systems are available:

- Forward Collision Mitigation with brake intervention, refer to page 180.
- The exit warning, refer to page 189.
- The Lane Departure Warning, refer to page 191.
- The Lane Change Warning, refer to page 195.
- The side collision warning, refer to page 198.
- The rear-collision warning, refer to page 200.
- The Traffic Light And Sign Warning, refer to page 201.
- The wrong way warning, refer to page 203.
- No Turn on Red function, refer to page 204.
- The Emergency Stop Assistant, refer to page 205.

The Intelligent Safety systems can be activated or deactivated on the Interaction Unit. Some functions, e.g., warning times, can be configured.

Safety information

Warning

The system cannot serve as a substitute for the driver's personal judgment in assessing the traffic situation. Based on the limits of the system, it cannot independently react to all traffic situations. There

is a risk of accident, injury, and property damage. Adjust driving style to traffic conditions. Watch the surrounding traffic situation closely, be ready to take over steering and braking at any time, and actively intervene where appropriate.

Warning

Indicators and warnings cannot serve as a substitute for the driver's personal judgment. Due to its limits, the system may not issue warnings or responses, or these may be issued late or in a manner that is not consistent with their normal use. There is a risk of accident, injury, and property damage. Adjust driving style to traffic conditions. Watch surrounding traffic closely and actively intervene where appropriate

Sensors

Depending on vehicle equipment, the Intelligent Safety systems are controlled by the following sensors:

- Camera behind the windshield.
- Front radar sensor.
- Side radar sensors, front.
- Side radar sensors, rear.

Additional information:

Sensors of the vehicle, refer to page 40.

Activating/deactivating/adjusting Intelligent Safety systems

1. To activate/deactivate Intelligent Safety systems or configure settings, go through the menu as follows: Apps menu / "Vehicle" / "Driving settings" / "Driver Assistance" / "Safety and warnings".
2. Select the desired settings.

Depending on national-market version, some Intelligent Safety Systems are automatically activated whenever you start driving.

Resetting the settings

The settings of the collision warning systems can be reset to the default settings at vehicle outbound delivery.

Go through the menu as follows:
Apps menu / "Vehicle" / "Driving settings" / "Driver Assistance" / "Safety and warnings" / "Reset".

System limits

Safety information

Warning

Because of system limitations, this system may either not respond, or respond too late, incorrectly, or without cause. There is a risk of accident, injury, and property damage. Actively intervene as warranted. Refer to the information in this Owner's Manual regarding the scope of the system's operation and limitations.

Detection capability

The detection capability of the collision warning systems is limited.

The system only takes into account objects that are located in the detection range of the installed sensors and are detected by the system.

Depending on the vehicle equipment, the area is monitored by cameras or radar sensors. Thus, a system response might not come or might come late.



System limits of the sensors

The Intelligent Safety systems may be restricted by the system limits of the sensors.

Additional information:

Sensors of the vehicle, refer to page 40.

Forward Collision Mitigation with brake intervention

Principle

Forward Collision Mitigation with brake intervention can help to prevent accidents within a certain speed range. To do so, the area around the vehicle is monitored by various sensors.

If an accident cannot be avoided, the system can help reduce the severity of the accident. The system can issue a warning of a possible risk of collision and activate the brakes independently, if needed. You can cancel automatic brake intervention manually, e.g., by actively moving the steering wheel.

Depending on vehicle equipment, the Forward Collision Mitigation system includes the following functions:

- The Rear-end collision warning function, refer to page 183.
- The oncoming traffic warning function, refer to page 184.
- The oncoming traffic warning function when turning, refer to page 185.
- The pedestrian warning function, refer to page 186.
- The intersection warning function, refer to page 187.
- The Evasion Assistant, refer to page 188.

Forward Collision Mitigation can be activated or deactivated using the Interaction

Unit. You can also configure the warning time. Various indicator lights and warning lights are displayed on the Interaction Unit depending on the collision risk detected.

Safety information

Warning

The system cannot serve as a substitute for the driver's personal judgment in assessing the traffic situation. Based on the limits of the system, it cannot independently react to all traffic situations. There is a risk of accident, injury, and property damage. Adjust driving style to traffic conditions. Watch the surrounding traffic situation closely, be ready to take over steering and braking at any time, and actively intervene where appropriate.

Warning

Indicators and warnings cannot serve as a substitute for the driver's personal judgment. Due to its limits, the system may not issue warnings or responses, or these may be issued late or in a manner that is not consistent with their normal use. There is a risk of accident, injury, and property damage. Adjust driving style to traffic conditions. Watch surrounding traffic closely and actively intervene where appropriate.

Sensors

Depending on vehicle equipment, the Forward Collision Mitigation system is controlled by the following sensors:

- Camera behind the windshield.
- Front radar sensor.
- Side radar sensors, front.

Additional information:

Sensors of the vehicle, refer to page 40.

Speed range

The Forward Collision Mitigation system issues a warning for a possible risk of collision at speeds above approx. 3 mph/5 km/h. If the vehicle speed exceeds approx. 155 mph/250 km/h, the system is deactivated temporarily.

Some functions are deactivated earlier.

The system is enabled as soon as the speed drops below this value again.

Activating/deactivating the Forward Collision Mitigation

Automatic activation of system

Depending on national-market version, the Forward Collision Mitigation is automatically activated whenever you start driving.

Activating the system manually

The Forward Collision Mitigation is activated by setting the warning time.

Additional information:

Set the warning time for Forward Collision Mitigation, refer to page 181.

Deactivating the system manually

Depending on national-market version, you must significantly reduce your vehicle's speed or stop your vehicle in order to deactivate the Forward Collision Mitigation manually. Forward Collision Mitigation is deactivated on the Interaction Unit.

It may be necessary to successively confirm this deactivation on the Interaction Unit.

Go through the menu as follows:
Apps menu / "Vehicle" / "Driving settings" / "Driver Assistance" / "Safety and warnings" / "Forward Collision Mitigation" / "Off".

Setting the warning time for Forward Collision Mitigation

You can configure the warning time at which Forward Collision Mitigation should issue a warning.



1. Go through the menu as follows:
Apps menu / "Vehicle" / "Driving settings" / "Driver Assistance" / "Safety and warnings" / "Forward Collision Mitigation".
2. Select the desired setting.

The more sensitive the warning time is set to be, the more warnings will be displayed. The system can therefore also issue more early or unfounded warnings and reactions.



The system checks for visual impairments. Depending on vehicle equipment, the Driver Attention Camera on the instrument panel monitors where the driver is looking. Visibility and gaze behavior also affect the timing of warnings.

Interaction Unit view

Forward Collision Mitigation is shown on the Interaction Unit and, depending on vehicle equipment, Head-up display by the following indicator lights and warning lights:

Icon	Meaning
	Risk of collision with a person, e.g., a pedestrian.
	Risk of collision, for instance with an oncoming or a vehicle driving ahead.
	Risk of collision, e.g., with a vehicle crossing from the right.



Icon	Meaning
	Risk of collision, e.g., with a vehicle crossing from the left.
	General risk of collision.

Indicator lights and warning lights may be displayed differently since the system has detected multiple objects.

Warning function

The Forward Collision Mitigation warns on different warning levels, depending on the respective hazardous situation.

In the event of a prewarning, a warning light illuminates red. In the event of an acute warning, a warning light flashes red and a warning tone sounds.

In the event of a system warning, the driver must intervene immediately and in accordance with the situation.

- Red warning light illuminates:
A hazardous situation has been detected. Increased awareness is required.
- Red warning light flashes:
There is a risk of collision. Intervene immediately.
- A warning signal sounds:
There is a risk of collision. Intervene immediately.
- Automatic brake intervention:
Depending on the equipment and situation in case of risk of imminent collision, the system can also intervene with an automatic brake intervention and automatically decelerate the vehicle, if necessary, to a complete stop.

When the brake pedal is depressed quickly and hard, the maximum brake power of the vehicle is used.

Automatic brake intervention

If there is a risk of collision, the Forward Collision Mitigation system can assist with an automatic brake intervention, if necessary.

When the vehicle is traveling at a low speed, the vehicle may come to a complete stop.

A brake intervention can be canceled by depressing the accelerator pedal with sufficient force, releasing the brake pedal, or by actively steering.

Depending on the equipment and situation, the brake intervention can occur up to approx. 155 mph/250 km/h.

At speeds above approx. 130 mph/210 km/h, only a brief brake intervention will occur.

System limits

Safety information

Warning

Because of system limitations, this system may either not respond, or respond too late, incorrectly, or without cause. There is a risk of accident, injury, and property damage. Actively intervene as warranted. Refer to the information in this Owner's Manual regarding the scope of the system's operation and limitations.

Detection capability

The detection capability of the Forward Collision Mitigation is restricted.

The system only takes into account objects that are located in the detection range of the installed sensors and are detected by the system.

Depending on the vehicle equipment, the area is monitored by cameras or radar sen-

sors. Thus, a system response might not come or might come late.

System limits of the sensors

Forward Collision Mitigation may be restricted by the system limits of the sensors. Additional information:

Sensors of the vehicle, refer to page 40.

Functional limitations

The Forward Collision Mitigation system may be limited in the following situations:

- In tight curves.
- With limitation of the driving stability control systems.
- Up to 10 seconds after drive-ready state is turned on via the Start/Stop switch.

Also, do not use Forward Collision Mitigation when towing.

Warning function in rear-end collision situations

Principle

To warn the driver of a possible risk of collision, the Rear Collision Warning function displays a warning light on the Interaction Unit and brakes automatically when necessary. You can cancel automatic brake intervention manually, e.g., by actively moving the steering wheel.

In the event of an accident, the system helps by reducing impact speed.

The time of warnings may vary depending on the current driving situation.

The system considers the driver's vehicle handling when responding. If an active driving style is detected, warnings and brake interventions occur less frequently.

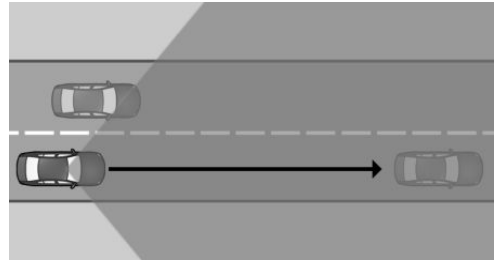

The sensors detect the traffic situation in their detection range.

Safety information



Follow the safety information in Chapter "Forward Collision Mitigation".

Speed range

The rear-end collision warning function is activated when your vehicle speed is greater than approx. 3 mph/5 km/h.

Interaction Unit view

If there is a risk of collision with a detected vehicle, a warning light is shown on the Interaction Unit and Head-up display, depending on vehicle equipment.

Icon	Meaning
	Forward Collision Warning with a detected vehicle.
	General risk of collision.

Warning function

The rear-end collision warning function issues warnings on different levels, depending on the respective hazard situation. This system prompts the driver to intervene manually.

Additional information:

Forward Collision Mitigation, refer to page 180.

System limits

General information

Follow the system limits in the "Forward Collision Mitigation" chapter.

Detection range

With the rear-end collision warning function, the following may not be detected or may be detected only with a delay in the detection range of the sensors, e.g.:

- Preceding vehicle driving slowly and being approached at high speed.
- Vehicles that suddenly swerve in front of you, or strongly decelerating vehicles.
- Vehicles with unusual rear designs.

Warning function for oncoming traffic

Principle

To warn the driver of a possible risk of collision with oncoming traffic, the Oncoming Traffic Warning function displays a warning light on the Interaction Unit and brakes automatically when necessary. You can cancel automatic brake intervention manually, e.g., by actively moving the steering wheel.

In the event of an accident, the system helps by reducing impact speed.

The time of warnings may vary depending on the current driving situation.

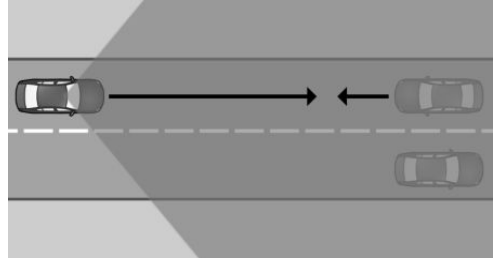

The sensors detect the traffic situation in their detection range.

Safety information



Follow the safety information in Chapter "Forward Collision Mitigation".

Speed range

The oncoming traffic warning is activated when your vehicle speed is greater than approx. 3 mph/5 km/h.

Interaction Unit view

If there is a risk of collision with a detected vehicle, a warning light is shown on the Interaction Unit and Head-up display, depending on vehicle equipment.

Icon	Meaning
	Oncoming traffic warning when a vehicle is detected.
	General risk of collision.

Warning function

The oncoming traffic warning function issues warnings on different levels, depending on the respective hazard situation. This system prompts the driver to intervene manually.

In case of a possible risk of collision, a brake intervention is triggered.

Additional information:

Forward Collision Mitigation, refer to page 180.

System limits

General information

Follow the system limits in the "Forward Collision Mitigation" chapter.

Detection range

With the oncoming traffic warning function, the following may not be detected or may be detected only with a delay in the detection range of the sensors, e.g.:

- Oncoming vehicles at a very high speed.
- Vehicles with an unusual front view.

Warning function for turning with oncoming traffic

Principle

To warn the driver of a possible risk of collision with oncoming traffic when turning, the Oncoming Traffic Warning function displays a warning light on the Interaction Unit and brakes automatically when necessary. You can cancel automatic brake intervention manually, e.g., by actively moving the steering wheel.

In the event of an accident, the system helps by reducing impact speed.

The time of warnings may vary depending on the current driving situation.

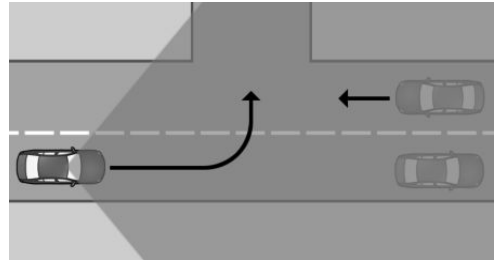

The sensors detect the traffic situation in their detection range.

Safety information

Follow the safety information in Chapter "Forward Collision Mitigation".



Speed range

The warning function for turning is activated when your vehicle speed is greater than approx. 3 mph/5 km/h.

This system reacts when your vehicle speed is less than approx. 15 mph/25 km/h.

Interaction Unit view

If there is a risk of collision with a detected vehicle, a warning light is shown on the Interaction Unit and Head-up display, depending on vehicle equipment.

Icon	Meaning
	Oncoming traffic warning when a vehicle is detected.
	General risk of collision.

Warning function

The warning function for turning with oncoming traffic issues warnings on different levels, depending on the respective hazard. This system prompts the driver to intervene manually.

Additional information:

Forward Collision Mitigation, refer to page 180.

System limits

General information

Follow the system limits in the "Forward Collision Mitigation" chapter.

Detection range

With the warning function for turning with oncoming traffic, the following may not be detected or may be detected only with a delay in the detection range of the sensors, e.g.:

- Oncoming vehicles at a very high speed.
- Vehicles that are hidden by other vehicles.
- Vehicles with an unusual front view.

Warning function for pedestrians

Principle

To warn the driver of a possible risk of collision with a pedestrian, the Pedestrian Warning function displays a warning light on the Interaction Unit and brakes automatically when necessary. You can cancel automatic brake intervention manually, e.g., by actively moving the steering wheel.

The system issues warnings for speeds that are common in towns and cities.

In the event of an accident, the system helps by reducing impact speed.

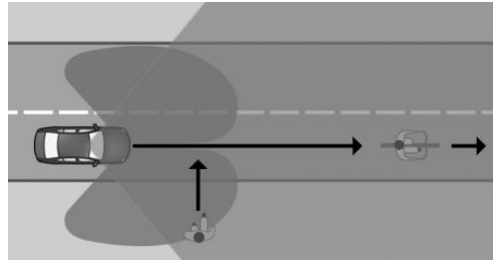

The sensors detect the traffic situation in their detection range on a straight road.

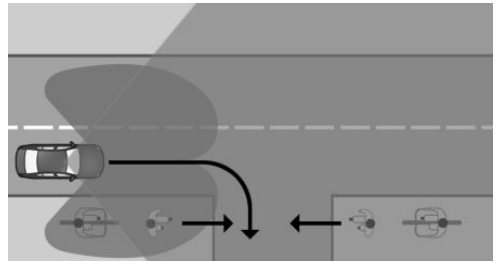

In addition, the sensors detect the traffic situation in their detection range when turning.

Safety information

Follow the safety information in Chapter "Forward Collision Mitigation".



Speed range

The Pedestrian Warning function is activated when your vehicle speed is greater than approx. 3 mph/5 km/h.

Depending on vehicle equipment, this system reacts when your vehicle speed is less than approx. 50 mph/80 km/h.

Interaction Unit view

If there is a risk of collision with a detected pedestrian or cyclist, a warning light is shown on the Interaction Unit and Head-up display, depending on vehicle equipment.

Icon	Meaning
	Risk of collision with a person, e.g., a pedestrian.
	General risk of collision.

- Partially covered pedestrians or bikes.
- Pedestrians that are not detected as such because of their contour or posture.
- Pedestrians who are too small for the sensors to detect.

Warning function

The Pedestrian Warning system issues warnings on different levels, depending on the respective hazard situation. This system prompts the driver to intervene manually.

Additional information:

Forward Collision Mitigation, refer to page 180.

System limits

General information

Follow the system limits in the "Forward Collision Mitigation" chapter.

Detection range

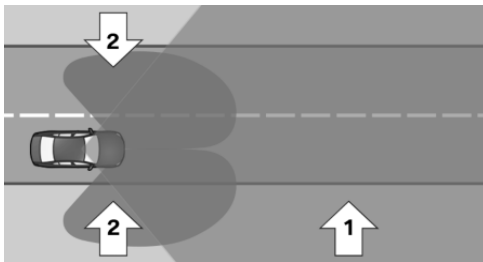

With the Pedestrian Warning, the sensor detection range consists of the following:

- From area in front of vehicle, arrow 1.
- If vehicle is equipped with front, side radar sensors, side areas, arrows 2.

The following situations may not be detected, for instance:

Warning function at intersections

Principle

To warn the driver of a possible risk of collision with crossing traffic, the Intersection Warning function displays a warning light on the Interaction Unit and brakes automatically when necessary. You can cancel automatic brake intervention manually, e.g., by actively moving the steering wheel.

At intersections and junctions, this system issues warnings for speeds that are common in towns and cities.

In the event of an accident, the system helps by reducing impact speed.

The time of warnings may vary depending on the current driving situation.

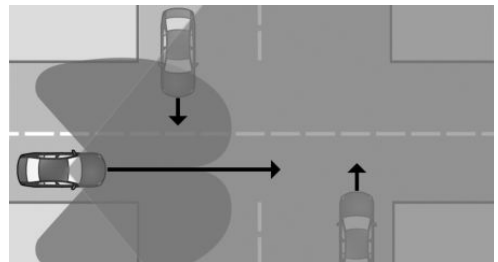

The sensors detect the traffic situation in their detection range.

Vehicles crossing your driving direction can be detected by the system as soon as these vehicles enter into detection range of the sensors.

Safety information

Follow the safety information in Chapter “Forward Collision Mitigation”.



Speed range

The Intersection Warning is activated when your vehicle speed is greater than approx. 3 mph/5 km/h.

The system responds to crossing vehicles when the vehicle speed is below approx. 50 mph/80 km/h.

Interaction Unit view

If there is a risk of collision with a detected vehicle, a warning light is shown on the Interaction Unit and Head-up display, depending on vehicle equipment.

Icon	Meaning
	Risk of collision with vehicle crossing from the right.
	Risk of collision with vehicle crossing from the left.
	General risk of collision.

Warning function

The Intersection Warning system issues warnings on different levels, depending on the respective hazard. This system prompts the driver to intervene manually.

Additional information:

Forward Collision Mitigation, refer to page 180.

System limits

General information

Follow the system limits in the “Forward Collision Mitigation” chapter.

Detection range

With the Intersection Warning function, the following may not be detected or may be detected only with a delay in the detection range of the sensors, e.g.:

- Crossing vehicles when they are hidden, e.g. by buildings.
- Vehicles with an unusual side view.
- Vehicles in highly dynamic driving situations.

Evasion Assistant

Principle

The Evasion Assistant can help the driver perform evasive maneuvers in certain situations, e.g., when obstacles or pedestrians appear suddenly. This system intervenes actively to assist the driver if it is possible to make an evasive maneuver to the side.

If the system detects sufficient free space alongside the vehicle, it helps the driver perform an evasive maneuver safely.

This system warns the driver of a possible risk of collision by displaying various warning lights on the Interaction Unit.

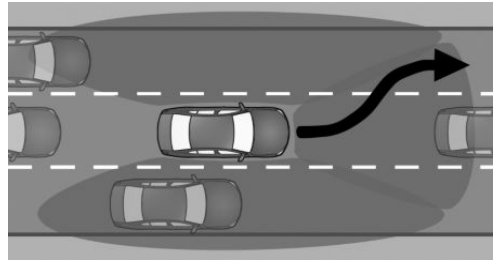

The sensors monitor and detect the clearance in front of the vehicle. Depending on the vehicle equipment, the areas next to the vehicle are also monitored.

Safety information

Follow the safety information in Chapter "Forward Collision Mitigation".

Functional requirements

The following functional requirements apply for the Evasion Assistant:



- Forward Collision Mitigation is active.
- Sensors have detected sufficient clearance around the vehicle.

Speed range

The Evasion Assistant helps the driver when the vehicle speed is between approx. 19 mph/30 km/h to 100 mph/160 km/h.

Interaction Unit view

If there is a risk of collision with a detected vehicle or person, e.g., a pedestrian, a warning light is shown on the Interaction Unit and Head-up display, depending on vehicle equipment.

Icon	Meaning
	Warning when a vehicle is detected.
	Risk of collision with a pedestrian.
	Risk of collision with unknown obstacle.

Warning function with evasion support

If the vehicle approaches another object at a high differential speed, a warning is displayed if there is an immediate risk of collision.

Intervene in case of a warning.

The system is designed to provide assistance during evasive maneuvers when there is a risk of collision.

The Evasion Assistant is signaled by a message on the Interaction Unit and Head-up display, depending on vehicle equipment.

System limits

General information

Follow the system limits in the "Forward Collision Mitigation" chapter.

Detection range

With the Evasion Assistant, the following may not be detected in the sensor detection range, e.g.:

- Preceding vehicle driving slowly and being approached at high speed.
- Vehicles that suddenly swerve in front of you, or strongly decelerating vehicles.
- Vehicles with unusual rear designs.
- Two-wheeled vehicles ahead of you.
- Partially covered pedestrians or bikes.
- Pedestrians that are not detected as such because of their contour or posture.
- Pedestrians who are too small for the sensors to detect.

Functional limitation

This system is deactivated when the trailer power socket is occupied or trailer towing is activated, e.g., when using a trailer or rear bicycle rack.

Exit warning

Principle

The exit warning helps to avoid accidents.



The system monitors the vehicle's surroundings for a limited time after you get in or park. When opening doors, vehicle occupants are then warned if a risk of collision with an approaching object is detected.

A possible risk of collision is indicated by various warnings, e.g., warning light on the exterior mirror and a warning tone.

The warning light in the exterior mirror gives warnings at different levels.

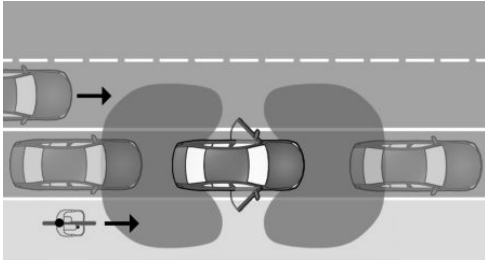

The sensors monitor the area behind the vehicle.

Depending on the vehicle equipment, the area around the vehicle in front of the vehicle is monitored as well.

The exit warning can be activated or deactivated on the Interaction Unit. This warning function can also be configured.

Safety information

Follow the safety information in the "Forward Collision Mitigation" chapter.

Sensors

The Exit Warning is controlled by the following sensors:

- Side radar sensors, rear.
- Depending on whether vehicle is equipped with side front radar sensors.

Activating/deactivating the exit warning

Automatic activation of system

The exit warning activates automatically whenever you start driving if this function was switched on when you completed your last trip.

Deactivating the system manually

To deactivate the Exit Warning, go through the menu as follows: Apps menu / "Vehicle" / "Driving settings" / "Driver Assistance" / "Safety and warnings" / "Exit warning" / "Off".

Configuring the exit warning

1. To configure the Exit Warning, go through the menu as follows: Apps menu / "Vehicle" / "Driving settings" / "Driver Assistance" / "Safety and warnings" / "Exit warning".
2. Select the desired setting.

Turning the warning signal on/off

To turn the Exit Warning tone on/off, go through the menu as follows: Apps menu / "Vehicle" / "Driving settings" / "Driver Assistance" / "Safety and warnings" / "Exit warning" / "Warning tone".

Displays

Warning light in exterior mirror

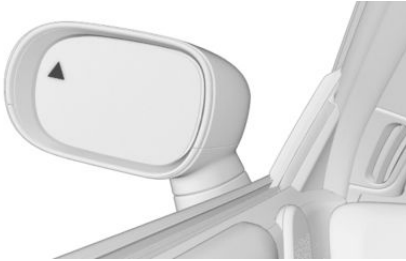

The warning light in the exterior mirror warns of a possible collision with a detected vehicle.

Ambient light

Depending on the equipment, warnings are also indicated by the ambient light in the interior.

Warning function

Prewarning

In the event of a prewarning for the Exit Warning, the warning light on the exterior mirror illuminates. Depending on the equipment, the ambient light also flashes.

An object was detected in the opening area of the doors. Increased awareness is required.

Acute warning

In the event of an acute Exit Warning, the warning light on the exterior mirror flashes, as does the ambient light, depending on vehicle equipment. In addition, a warning tone sounds.

There is a risk of collision when opening the doors.

System limits

General information

Follow the system limits in the "Collision warning systems" chapter.

Detection range

With the Exit Warning, the following may not be identified in the sensor detection range, e.g.:

- Fully or partially hidden objects.
- Stationary or very slow objects.
- Pedestrians.

Functional limitations

The exit warning system may be restricted in the following situations:

- The speed of an approaching vehicle is too fast or too slow.
- In curves.
- In case of fully or partially hidden objects.

Lane Departure Warning with active return

Principle

The Lane Departure Warning system with active return alerts the driver when their vehicle is about to leave the road or lane.

An automatic steering intervention helps to keep the vehicle in its lane.

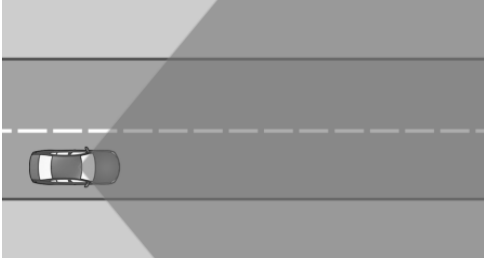

The sensors detect the traffic situation in their detection range.

The Lane Departure Warning can be activated, deactivated, and configured on the Interaction Unit.

Various warning functions from this system help the driver keep their vehicle in their lane.

If you set your turn signal for the corresponding direction before leaving your lane, no warnings are displayed.

Safety information

Warning

The system cannot serve as a substitute for the driver's personal judgment in assessing road and traffic situations. There is a risk of accident, injury, and property damage. Adjust driving style to traffic conditions. Watch surrounding traffic closely and actively intervene where appropriate. Do not jerk the steering wheel in response to a warning.

Warning

Indicators and warnings cannot serve as a substitute for the driver's personal judgment. Due to its limits, the system may not issue warnings or responses, or these may be issued late or in a manner that is not consistent with their normal use. There is a risk of accident, injury, and property

damage. Adjust driving style to traffic conditions. Watch surrounding traffic closely and actively intervene where appropriate

Functional requirement

For the Lane Departure Warning to activate, the camera must detect the lane boundary.

Speed range

The Lane Departure Warning is activated when your vehicle exceeds a given minimum speed. The minimum speed is country-specific and displayed on the Interaction Unit.

Sensors

Depending on vehicle equipment, the Lane Departure Warning system is controlled by the following sensors:

- Camera behind the windshield.
- Front radar sensor.
- Side radar sensors, front.

Activating/deactivating the Lane Departure Warning

Automatic activation of system

Depending on national-market version, the system is automatically activated whenever you start driving.

Activating the system manually

The Lane Departure Warning is activated by setting the warning time.

Additional information:

Configuring the Lane Departure Warning, refer to page 193.

Deactivating the system manually

Depending on vehicle equipment and national-market version, deactivation of the Lane Departure Warning must be confirmed successively on the Interaction Unit.

Go through the menu as follows:
Apps menu / "Vehicle" / "Driving settings" / "Driver Assistance" / "Safety and warnings" / "Lane Departure Warning" / "Off".

Setting Lane Departure Warning

The Lane Departure Warning menu can be used to configure this function and specify when it should issue warnings.

1. Go through the menu as follows: Apps menu / "Vehicle" / "Driving settings" / "Driver Assistance" / "Safety and warnings" / "Lane Departure Warning".

2. Select the desired setting.

- "Expanded"

If the system detects that your vehicle is about to leave your lane or cross a lane marking, a warning is issued. The system performs a steering intervention.

- "In dangerous situations"

A warning is issued if the system detects that the vehicle is about to inadvertently cross a lane marking, or if the sensors detect an oncoming vehicle. A steering intervention is performed.

Depending on national-market version, with continuous lane markings: If the system detects that your vehicle is about to inadvertently leave your lane or cross a lane marking, a warning is issued. A steering intervention is performed.

Setting the intensity of the steering wheel vibration

1. To adjust the steering wheel vibration intensity, go through the menu as follows: Apps menu / "Vehicle" / "Driving settings" / "Driver Assistance" / "Feedback via steering wheel" / "Vibration intensity".

2. Select the desired setting.

The setting is applied to all collision warning systems.

Depending on national-market version: activate/deactivate steering intervention

Depending on national-market version, the Lane Departure Warning steering intervention can be activated or deactivated.

Go through the menu as follows:
Apps menu / "Vehicle" / "Driving settings" / "Driver Assistance" / "Safety and warnings" / "Lane Departure Warning" / "Steering intervention".

Depending on the national-market version, the steering intervention is automatically active after every driving off.

Interaction Unit view

Depending on vehicle equipment and national-market version, different warnings for the Lane Departure Warning are displayed on the Interaction Unit.

Icon	Meaning
	Indicator light flashes green: System is actively issuing a warning. If necessary, the system performs a steering intervention.

Depending on vehicle equipment and national-market version, information for the system is shown in Assisted View on the Interaction Unit.



Additional information:

Assisted View, refer to page 157.

Warning function

General information

Different warnings are issued by the Lane Departure Warning system, depending on situation and speed:

- Indicator lights and warning lights on the Interaction Unit.
- Vibration of steering wheel.
- Steering intervention.
- Warning tone.

Steering wheel vibration

If you leave the lane and if a lane boundary has been detected, the steering wheel vibrates in accordance with the steering wheel vibration setting.

A light is also displayed on the Interaction Unit.

When the turn signal is switched on in the corresponding direction before changing the lane, a warning is not issued.

Steering intervention

Depending on vehicle equipment and national-market version: The Lane Departure Warning system may intervene with an active steering intervention in addition to vibration if you cross a lane marking at speeds up to 130 mph/210 km/h. The system supports the driver in keeping the vehicle within the lane. The steering intervention can be noticed on the steering wheel and can be manually overridden at any time.

During an active steering intervention, a light is displayed on the Interaction Unit.

For instance, the steering intervention will be suppressed in the following situations:

- With hard accelerating or braking.
- When flashing.
- With hazard warning system switched on.
- In driving situation with high driving dynamics.
- While Dynamic Stability Control regulates driving stability.
- While Dynamic Stability Control is limited.
- Immediately following a steering intervention by the vehicle systems.

End of warning

The warning or active steering intervention will be canceled in the following situations, for example:

- Automatically after a few seconds.
- When returning to your own lane.
- With hard accelerating or braking.
- With hazard warning system switched on.
- When flashing.
- While Dynamic Stability Control regulates driving stability.
- Immediately following a steering intervention by the vehicle systems.
- With manual steering intervention.
- When another driver assistance system is activated, if applicable.
- When no lane markings are detected.
- When the system limits are reached.

Warning signal

A warning tone sounds if the driver does not actively steer after the Lane Departure Warning system has performed multiple active steering interventions within one minute.

In addition, a Check Control message is displayed.

The warning tone and Check Control message advise the driver to pay closer attention to their lane.

The longer warning tone is stopped if the driver takes control of the steering.

With trailer towing

When the Lane Departure Warning is activated, no steering intervention is performed if the trailer power socket is occupied or trailer towing is activated, e.g., when using a trailer.

When using a rear carrier, e.g., a rear bicycle rack, on the trailer hitch, this restriction does not apply when trailer towing is activated on the Interaction Unit.

Additional information:

Driving with trailer or rear carrier, refer to page 320.

System limits

General information

Follow the system limits in the "Collision warning systems" chapter.

Functional limitations

The Lane Departure Warning system may be restricted in the following situations:

- In the event of missing, worn, poorly visible, merging, diverging, or multiple lane boundaries such as in construction areas.
- With lane boundaries that are covered in snow, ice, dirt or water.
- In tight corners or on narrow roads.
- With lane boundaries that are covered by objects.
- When driving very close to the vehicle in front of you.
- Up to 10 seconds after drive-ready state is turned on via the Start/Stop switch.

- While Dynamic Stability Control regulates driving stability.
- While Dynamic Stability Control is limited.

A Check Control message may be displayed when the system is limited. A yellow warning light also illuminates, depending on national-market version.

Active Blind Spot Detection with active return

Principle

The Lane Change Warning system with active return detects vehicles in your blind spot or vehicles approaching from behind in the adjacent lane.

An automatic steering intervention helps to keep the vehicle in its lane.

A possible risk of collision is indicated by various warnings, e.g., signaled by warning light on the exterior mirror.

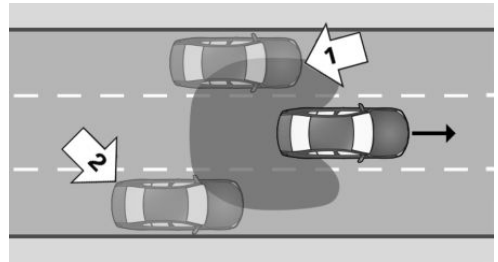

The sensors monitor the area behind and next to the vehicle.

The system indicates whether there are vehicles in your blind spot, arrow 1, or approaching from behind in an adjacent lane, arrow 2. The warning light in the exterior mirror illuminates dimly.

The system will warn in the previously named situations prior to a lane change. The warning light on the exterior mirror flashes



and the steering wheel vibrates at the set intensity.

Active Blind Spot Detection can be activated, deactivated, and configured on the Interaction Unit.

Safety information

Follow the safety information in the "Forward Collision Mitigation" chapter.

Speed range

Active Blind Spot Detection is activated when your vehicle exceeds a given minimum speed. The minimum speed is country-specific and displayed in the Active Blind Spot Detection menu.

When turning at a speed of up to approx. 12 mph/20 km/h, the steering wheel will not vibrate.

This system is temporarily deactivated at speeds greater than approx. 155 mph/250 km/h.

If the vehicle speed falls below approx. 155 mph/250 km/h, the system is reactivated.

Sensors

Active Blind Spot Detection is controlled by the following sensors:

- Camera behind the windshield.
- Side radar sensors, rear.
- Depending on whether vehicle is equipped with side front radar sensors.

Activating/deactivating the Lane Change Warning

1. To activate/deactivate Active Blind Spot Detection, go through the menu as follows: Apps menu / "Vehicle" / "Driving settings" / "Driver Assistance" / "Safety

and warnings" / "Active Blind Spot Detection".

2. Select the desired setting.

Depending on vehicle equipment and national-market version, Active Blind Spot Detection activates automatically whenever you start driving.

Adjusting the Active Blind Spot Detection

1. To configure Active Blind Spot Detection, go through the menu as follows: Apps menu / "Vehicle" / "Driving settings" / "Driver Assistance" / "Safety and warnings" / "Active Blind Spot Detection".
2. Select the desired setting.

You can configure how many warnings will be shown. However, there may also be an excess of unwarranted warnings of critical situations.

Setting the intensity of the steering wheel vibration

1. To adjust the steering wheel vibration intensity, go through the menu as follows: Apps menu / "Vehicle" / "Driving settings" / "Driver Assistance" / "Feedback via steering wheel" / "Vibration intensity".
2. Select the desired setting.

The setting is applied to all collision warning systems.

Depending on national-market version: activate/deactivate steering intervention

Depending on national-market version, the Lane Change Warning steering intervention can be activated or deactivated.

Go through the menu as follows: Apps menu / "Vehicle" / "Driving

settings" / "Driver Assistance" / "Safety and warnings" / "Active Blind Spot Detection" / "Steering intervention".

Warning function

Warning light in exterior mirror

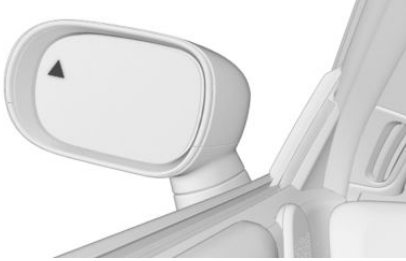

The warning light in the exterior mirror warns of a possible collision with a detected vehicle.

Prewarning

In the event of a prewarning for Active Blind Spot Detection, the dimmed warning light on the exterior mirror indicates when vehicles are in your blind spot or approaching from the rear.

Acute warning

When an acute warning is issued by Active Blind Spot Detection, the steering wheel vibrates briefly. The warning light in the exterior mirror flashes brightly.

An acute warning is issued if the following conditions are met:

- Another vehicle is located in the critical area.
- Your own vehicle is approaching the other lane.
- Depending on the system setting when the turn signal is turned on.

The warning stops when the other vehicle has left the critical area.

Steering intervention

Depending on national-market version: The Active Blind Spot Detection system may perform an active steering intervention when there is no response to the steering wheel vibration and a lane marking is crossed at speeds of up to 130 mph/210 km/h. The steering intervention helps return the vehicle into the lane. The steering intervention can be noticed on the steering wheel and can be manually overridden at any time.

The steering intervention is carried out from a minimum speed. This minimum speed is displayed on the Interaction Unit.

With trailer towing

No steering intervention is performed when the trailer power socket is occupied or trailer towing is activated. Active Blind Spot Detection does not issue a pre-warning.

Depending on vehicle equipment and national-market version, an acute warning will continue to be issued if there is a risk of collision.

The warning function may be restricted. Warnings can be displayed late or not at all, e.g., if the speed of the approaching vehicle is much higher than your own speed. An increased number of unwarranted warnings may occur. A Check Control message is displayed.

Warning light flashing

As a self-test of Active Blind Spot Detection, the warning light on the exterior mirror flashes briefly when the vehicle is unlocked.

System limits

General information

Follow the system limits in the "Collision warning systems" chapter.

Functional limitations

The Lane Change Warning system may be restricted in the following situations:

- When a vehicle is approaching at a speed much faster than your own.
- In tight corners or on narrow roads.
- The bumper is dirty, iced up or covered, for instance by stickers.

Depending on the national-market version, the steering intervention e.g. in the following situations:

- In the event of missing, worn, poorly visible, merging, diverging, or multiple lane boundaries such as in construction areas.
- With lane boundaries that are covered in snow, ice, dirt or water.
- With lane boundaries that are not white.
- With lane boundaries that are covered by objects.
- When driving very close to the vehicle in front of you.
- If the camera is impaired.
- Up to 10 seconds after drive-ready state is turned on via the Start/Stop switch.

A Check Control message may be displayed when the system is limited. A yellow warning light also illuminates, depending on national-market version.

This system may be restricted or deactivated when the trailer power socket is occupied or trailer towing is activated, e.g., when using a trailer or rear bicycle rack. A Check Control message is displayed.

Side collision mitigation

Principle

The side-collision warning helps to avoid an impending side collision.

If, for example, another vehicle is detected next to your vehicle and there is a risk of collision with this vehicle, the system helps avoid a collision. To do so, the system issues a warning by flashing the warning light on the exterior mirror, issuing a Check Control message, and vibrating the steering wheel.

If necessary, an active steering intervention is performed by the system.

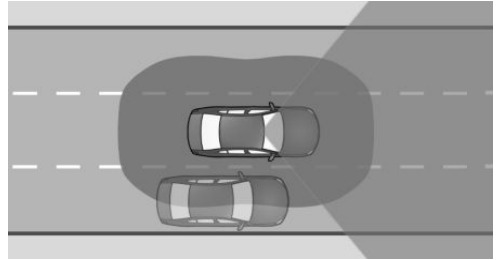

The sensors monitor the space next to the vehicle.

The Side Collision Warning can be activated/deactivated on the Interaction Unit. The severity of the steering wheel vibration can be adjusted.

Safety information

Follow the safety information in the "Forward Collision Mitigation" chapter.

Functional requirement

The camera behind the windshield determines the lane boundary positions.

For the side-collision warning with steering intervention to activate, the camera must detect the lane boundary.

Speed range

The side-collision warning function is activated when your vehicle exceeds a given minimum speed. The minimum speed is country-specific and displayed on the Interaction Unit.

This system responds when your vehicle speed is less than approx. 130 mph/210 km/h.

Sensors

The side-collision warning is controlled by the following sensors:

- Camera behind the windshield.
- Side radar sensors, front.
- Side radar sensors, rear.

Activating/deactivating the side-collision warning

1. To activate/deactivate the Side Collision Warning, go through the menu as follows: Apps menu / "Vehicle" / "Driving settings" / "Driver Assistance" / "Safety and warnings" / "Side collision warning".
2. Select the desired setting.

Setting the intensity of the steering wheel vibration

1. To adjust the steering wheel vibration intensity, go through the menu as follows: Apps menu / "Vehicle" / "Driving settings" / "Driver Assistance" / "Feedback via steering wheel" / "Vibration intensity".
2. Select the desired setting.

The setting is applied to all collision warning systems.

Interaction Unit view

Depending on vehicle equipment and national-market version, Side Collision Warning information is shown in Assisted View on the Interaction Unit.

Additional information:

Assisted View, refer to page [157](#).

Warning function

Warning light in exterior mirror

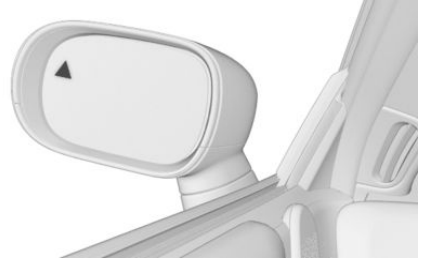

The warning light in the exterior mirror warns of a possible collision with a detected vehicle.

Acute warning

In the event of an acute side-collision warning, the warning light on the exterior mirror flashes and the steering wheel begins to vibrate if there is a risk of collision.

A Check Control message is displayed at the same time.

Steering intervention

Depending on the national-market version, if necessary, the system engages the active steering intervention to prevent a collision and maintain the vehicle within its own lane. The steering intervention can be noticed on the steering wheel and can be manually overridden at any time.

System limits

General information

Follow the system limits in the "Collision warning systems" chapter.

Functional limitations

The side-collision warning system may be restricted in the following situations:



- In tight corners or on narrow roads.
- In the event of missing, worn, poorly visible, merging, diverging, or multiple lane boundaries such as in construction areas.
- With lane boundaries that are covered in snow, ice, dirt or water.
- With lane boundaries that are not white.
- With lane boundaries that are covered by objects.
- When driving very close to the vehicle in front of you.
- Up to 10 seconds after drive-ready state is turned on via the Start/Stop switch.

A Check Control message may be displayed when the system is limited.

This system is deactivated when the trailer power socket is occupied or trailer towing is activated, e.g., when using a trailer or rear bicycle rack. A Check Control message is displayed.

Rear-end collision preparation

Principle

Depending on the equipment and national-market version, the rear-end collision preparation can react to vehicles approaching from behind.

Depending on the national-market version, the hazard warning flashers are switched on and PreCrash functions are triggered where applicable if a vehicle approaching at a certain speed is detected.

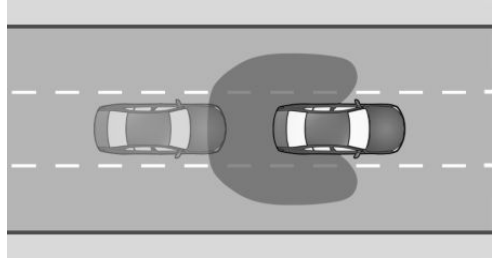

The sensors monitor the area behind the vehicle.

The rear-end collision preparation function is activated automatically when you start driving and is deactivated automatically in certain situations.

Safety information

Follow the safety information in the "Forward Collision Mitigation" chapter.

Sensors

The rear-end collision preparation function is controlled by the side, rear radar sensors.

Activating/deactivating the rear-collision warning

The rear-collision warning is automatically activated whenever you start driving.

The system is deactivated in the following situations:

- When reversing.
- When the trailer power socket is occupied or trailer towing is activated, e.g., when using a trailer or rear bicycle rack.

System limits

General information

Follow the system limits in the "Collision warning systems" chapter.

Functional limitations

The rear-collision warning may be restricted if the speed of the approaching vehicle is much higher or similar to your own speed.

Traffic Light And Sign Warning

Principle

The Traffic Light And Sign Warning provides support in situations in which the right-of-way needs to be yielded based on road signs or traffic lights.

This system uses a camera to analyze traffic signs and traffic lights. The navigation system directs information on the road layout to the system.

For warning purposes, the respective traffic situation is shown on the Interaction Unit. An acoustic signal also sounds in acute warning situations.

A warning is given if the right of way is about to be violated, e.g., in the following traffic situations:

- At an intersection.
- At a road entrance.
- On a highway entrance ramp.
- At a roundabout.
- With a red traffic light.

The Traffic Light And Sign Warning can be activated or deactivated on the Interaction Unit. You can also configure the warning time.



Safety information

Follow the safety information in the "Forward Collision Mitigation" chapter.

Functional requirement

The right-of-way situation ahead of the vehicle must be clearly controlled by traffic signs or light signal systems.

Various traffic signs are taken into account for the Traffic Light And Sign Warning:

Sign	Meaning
	Give way signs: A pre-warning is issued for these road signs.
	Stop signs: A pre-warning is issued for these road signs.
	When traffic lights are red, a pre-warning and an acute warning will be issued.

Speed range

The Traffic Light And Sign Warning system issues a warning as from a variable minimum speed and at speeds up to approx. 60 mph/100 km/h.

Sensors

The Traffic Light And Sign Warning is controlled by the camera behind the windshield.

Activating/deactivating the Traffic Light And Sign Warning

1. To activate/deactivate the Traffic Light And Sign Warning, go through the menu as follows: Apps menu / "Vehicle" / "Driving settings" / "Driver Assistance" / "Safety and warnings" / "Traffic Light and Sign Warning".
2. Select the desired setting.



Setting the warning time for the Traffic Light And Sign Warning

1. To configure the warning time for the Traffic Light And Sign Warning, go through the menu as follows: Apps menu / "Vehicle" / "Driving settings" / "Driver Assistance" / "Safety and warnings" / "Traffic Light and Sign Warning".
2. Select the desired setting.

The selected setting is saved and adopted for the next journey.

Warning function

General information

The Traffic Light And Sign Warning system issues warnings in two levels.



If a prewarning is issued, the system indicates this by the icon on the Interaction Unit.

If an acute warning is issued, the system indicates this by the icon on the Interaction Unit and the signal tone.

The timing of the warning varies with the actual driving situation and the warning time setting.

Prewarning

If a prewarning is issued for the Traffic Light And Sign Warning because there is a risk that a vehicle is not yielding the right-of-way, an icon is displayed on the Interaction Unit:

Icon	Meaning
	Give way.
	Stop.
	Red traffic light.

When a prewarning is issued, intervene as appropriate for the situation; for example, by braking.

Acute warning

If an acute warning is issued for the Traffic Light And Sign Warning because there is a risk that a vehicle is not yielding the right-of-way, a signal tone sounds and an icon is displayed on the Interaction Unit:

Icon	Meaning
	Red traffic light.

When an acute warning is issued, intervene as appropriate for the situation; for example, by braking.

Display in the Head-up display

Depending on vehicle equipment, the Traffic Light And Sign Warning is displayed simultaneously on the Head-up display and Interaction Unit.

System limits

General information

Follow the system limits in the "Collision warning systems" chapter.

No warning

The Traffic Light And Sign Warning does not issue a warning in the following situations, for example:

- In right-of-way situations without right-of-way signs, stop signs, or red light signal systems.
- With intersections with relevant traffic lights that are illuminated yellow or green.

Functional limitations

The Traffic Light And Sign Warning system may be limited in the following situations:

- If road signs or light signal systems are unclear.
- If traffic signs or light signal systems are fully or partially concealed or soiled.
- If traffic signs or light signal systems are difficult to read or rotated.
- If traffic signs or light signal systems are too small or too large.
- If the traffic signs do not correspond to the standard.
- When traffic signs are detected that apply to a junction or parallel street.
- In the presence of country-specific road signs or road layouts.
- With intersections with flashing light signal systems.
- Up to 10 seconds after drive-ready state is turned on via the Start/Stop switch.
- In the case of navigation data that is invalid, outdated or not available.
- In some regions, the system may not be available or only partially available.

Wrong way warning

Principle

The wrong way warning warns the driver of an upcoming wrong entry onto roads, for instance onto freeways, roundabouts and one-way streets.

The system uses sensors and, depending on vehicle equipment, navigation data and traffic signs to monitor the traffic situation.

For warning purposes, the corresponding traffic sign is displayed on the Interaction Unit and an acoustic signal sounds.

Safety information

Follow the safety information in the "Forward Collision Mitigation" chapter.

Functional requirement

The road layout ahead must be controlled clearly with traffic signs.

The Wrong Way Warning system recognizes the following traffic signs, for example:

- No entrance.
- Roundabout.
- Direction arrows for required passing maneuver.

Sensors

The Wrong Way Warning function is controlled by the camera behind the windshield.

Activating/deactivating the wrong way warning

Depending on national-market version, the wrong way warning is automatically activated whenever you start driving.



Warning function



The Wrong Way Warning is displayed and an acoustic signal sounds when your vehicle is traveling in the wrong direction on a highway, roundabout, or one-way street, for example.

Warnings are displayed on the Interaction Unit and Head-up display, depending on vehicle equipment.

System limits

General information

Follow the system limits in the "Collision warning systems" chapter.

No warning

For example, the wrong way warning system does not issue warnings for roadways without traffic signs.

Functional limitations

The wrong way warning system may be restricted in the following situations, for example, and will either output an incorrect wrong way warning or no warning at all:

- When the signage is not clear.
- If the traffic signs are fully or partially concealed or soiled.
- If the traffic signs are poorly legible or rotated.
- If the traffic signs are too small or too large.
- If the traffic signs do not correspond to the standard.
- When traffic signs are detected that apply to a junction or parallel street.
- In the presence of country-specific road signs or road layouts.
- Up to 10 seconds after drive-ready state is turned on via the Start/Stop switch.

- In the case of navigation data that is invalid, outdated or not available.
- It may not be possible to use the system in all regions.

No Turn on Red function

Principle

The No Turn on Red function assists the driver by indicating at which traffic lights turning on red is prohibited.

To do so, this function analyzes traffic lights and traffic signs using the camera behind the windshield. In addition, the navigation system data is used.

Safety information

Follow the safety information in the "Forward Collision Mitigation" chapter.

Functional requirements

The following functional requirements apply to the No Turn on Red function:

- The system detects the right-of-way situation ahead by analyzing traffic lights and traffic signs.
- Vehicle is less than approx. 164 ft/50 m from the traffic lights.
- Depending on vehicle equipment, the Traffic Light And Sign Warning is activated.

Sensors

The No Turn on Red function is controlled by the camera behind the windshield.

Interaction Unit view



If the driver approaches a red traffic light with a traffic sign that prohibits its turning on red, an indicator light is displayed on the Interaction Unit.

The indicator light goes out automatically after you drive off at a speed greater than approx. 9 mph/15 km/h.

System limits

General information

Follow the system limits in the "Collision warning systems" chapter.

Functional limitations

The No Turn on Red function may be limited in the following situations, for example:

- If road signs or light signal systems are unclear.
- If traffic signs or light signal systems are fully or partially concealed or soiled.
- If traffic signs or light signal systems are difficult to read or rotated.
- If traffic signs or light signal systems are too small or too large.
- If the traffic signs do not correspond to the standard.
- With intersections with flashing light signal systems.
- In the case of navigation data that is invalid, outdated or not available.
- In some regions, this function may not be completely available or not available at all.

Emergency Stop Assistant

Principle

The Emergency Stop Assistant assists the driver if they are no longer able to drive their vehicle safely. When the system is triggered, the vehicle is brought to a stop in its own lane by the lane keeping system.

The Interaction Unit can be used to enable/disable triggering of the Emergency Stop Assistant.

The driver can manually cancel the Emergency Stop Assistant at any time.

Safety information

Warning

The system cannot serve as a substitute for the driver's personal judgment in assessing one's physical state. An increasing lack of alertness or fatigue may not be detected or not be detected in time. There is a risk of accident, injury, and property damage. Make sure that the driver is rested and alert. Adjust driving style to traffic conditions.

Functional requirements

The following functional requirements apply for the Emergency Stop Assistant:

- The Emergency Stop Assistant is activated on the Interaction Unit.
- The system is activated from a speed of approx. 43 mph/70 km/h.
- The Driver Attention Camera detects driver activity.

Activating/deactivating Emergency Stop Assistant

To activate/deactivate triggering of the Emergency Stop Assistant, go through the menu as follows: Apps menu / "Vehicle" / "Driving settings" / "Driver Assistance" / "Safety and warnings" / "Emergency stop".

Triggering the Emergency Stop Assistant

If the Emergency Stop Assistant detects that the driver is no longer driving their vehicle safely or is ignoring warnings, the



system is triggered automatically. The triggered system is displayed on the Interaction Unit.

The Interaction Unit can be used to initiate an immediate emergency call.

The following is performed automatically when the Emergency Stop Assistant is triggered:

- A display appears on the Interaction Unit.
- The system takes over vehicle handling until the vehicle comes to a standstill.
- The hazard warning system is switched on.
- An emergency call is triggered when stationary, depending on vehicle equipment.

The Emergency Stop Assistant can also be triggered via voice input.

Additional information:

MINI Intelligent Personal Assistant, refer to page 55.

Canceling Emergency Stop Assistant

The driver can cancel the Emergency Stop Assistant at any point by taking active control of driving the vehicle.

The system is stopped by the following actions, for example:

- By firmly pressing the accelerator pedal.
- By stopping the system on the Interaction Unit.
- By operating the turn signal.
- By turning off the hazard warning system.
- By firmly countersteering.
- By changing the selector lever position when the vehicle was already at a standstill.

At standstill

As soon as the vehicle is stationary, the Emergency Stop Assistant will apply the following settings:

- The vehicle is secured against rolling away.
- The interior lights are switched on.
- The central locking system is unlocked.

Interaction Unit view

When triggered, the Emergency Stop Assistant is shown on the Interaction Unit.

Icon	Meaning
	The Emergency Stop Assistant has triggered.

System limits

The Emergency Stop Assistant does not release the driver from their obligation to drive safely in traffic.

This system may be restricted in the following situations:

- When the Driver Attention Camera is covered by the steering wheel.
- When wearing sunglasses with high protection against infrared light.

Cross Traffic Warning with brake intervention

Principle

The Cross Traffic Warning with brake intervention helps the driver by providing visual and acoustic warnings when driving through confusing exits or pulling out of perpendicular parking spaces.

The system detects road users approaching from the side earlier than would be possible from the driver's seat.

If there is a risk of collision when reversing, this system provides assistance by performing an automatic brake intervention.

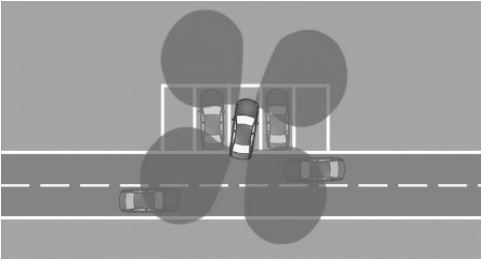

The sensors monitor the area behind the vehicle.

Depending on the vehicle equipment, the area around the vehicle in front of the vehicle is monitored as well.

The system displays a warning light on the exterior mirror, for example, when other road users are approaching.

The cross traffic warning can be activated or deactivated on the Interaction Unit.

General information

Follow the information in the "Parking assistance systems" chapter.

Safety information

Warning

The system cannot serve as a substitute for the driver's personal judgment in assessing the traffic situation. Based on the limits of the system, it cannot independently react to all traffic situations. There is a risk of accident, injury, and property damage. Adjust driving style to traffic conditions. Watch the surrounding traffic situation closely, be ready to take over steering and braking at any time, and actively intervene where appropriate.

Sensors

The Cross Traffic Warning is controlled by the following sensors:

- Side radar sensors, rear.
- Depending on whether vehicle is equipped with side front radar sensors.

Activating/deactivating Cross Traffic Warning

The system must be activated on the Interaction Unit for the Cross Traffic Warning and brake intervention to switch on automatically.

1. Go through the menu as follows: Apps menu / "Vehicle" / "Driving settings" / "Driver Assistance" / "Parking".
2. Select the desired setting, depending on vehicle equipment:
 - "Rear warning"
 - "Front and rear warning"
 - "Brake intervention at rear"

Turning on the cross traffic warning automatically

The Cross Traffic Warning must be activated on the Interaction Unit. The system turns on automatically as soon as Park Distance Control or a camera view activates and you engage a gear position.

If reverse gear is engaged, the rear system is switched on.

Depending on the equipment, the front system is turned on when a gear position is engaged.

Depending on the national-market version, the system is automatically active when the vehicle is started.



Turning off the cross traffic warning automatically

The Cross Traffic Warning switches off automatically in the following situations, for example:

- When walking speed is exceeded.
- When a certain distance covered is exceeded.

Warning function

General information

With the Cross Traffic Warning, the Interaction Unit displays the corresponding view, an acoustic signal may sound, and the warning light on the exterior mirror flashes.

When a brake intervention is performed, a message displays on the Interaction Unit then closes after a short time.

Visual warning

Warning light in exterior mirror

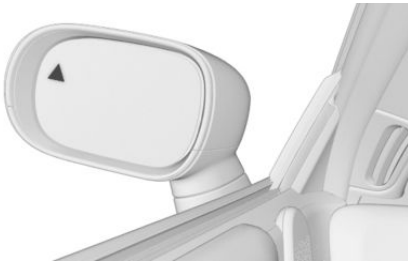

The warning light in the exterior mirror flashes if the rear sensors detect other vehicles when the vehicle is reversing.

Display in the Park Distance Control view

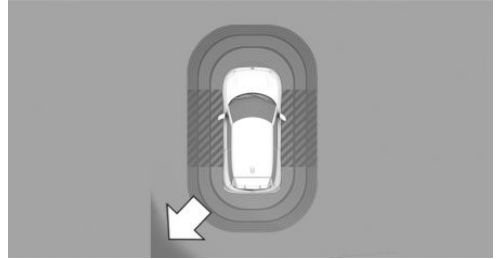

In the Park Distance Control view, the respective boundary area flashes red if vehicles are detected by the sensors.

Display in camera view

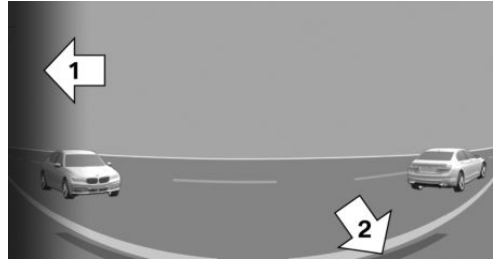

Depending on the direction of travel, the view to the front or back is displayed in the camera image.

The respective boundary area, arrow 1, in the camera image flashes red if vehicles are detected by the sensors.

Yellow lines, arrow 2, mark the bumper of your own vehicle.

Acoustic warning

In addition to the visual warning of the Cross Traffic Warning function, an acoustic signal sounds if your vehicle moves in the corresponding direction.

Depending on the national-market version, the signal tone will already sound when the gear position is engaged.

System limits

System limits of the sensors

The Cross Traffic Warning may be restricted by the system limits of the sensors.

Additional information:

Sensors of the vehicle, refer to page 40.

Functional limitations

The Cross Traffic Warning system may be restricted in the following situations:

- In tight curves.
- Crossing objects are moving at a very slow or a very fast speed.
- Other objects that hide cross traffic are in the capture range of the sensors.
- If the trailer power socket is occupied or trailer towing is activated, the cross traffic warning is not available for the area behind the vehicle.

Drive Recorder

Principle

The Drive Recorder stores brief video recordings your vehicle's surroundings, e.g., to document surrounding traffic. To do so, the system must be activated on the Interaction Unit before using it for the first time.

The Interaction Unit can be used to configure video recording settings, e.g., recording type and duration.

Video recordings can be saved in different ways:

- Automatic storage of recordings makes it possible to document the vehicle accident or theft using the corresponding recording type configured.
- Saving recordings manually helps you document traffic situations using your set recording type.

Depending on vehicle equipment, video recordings can be saved directly to a mobile device, e.g., smartphone.

Assistance system cameras are used to record, e.g., panorama view cameras.

In addition, the following parameters are stored for the trip:

- Date.
- Time.
- Speed.
- GPS coordinates.

Vehicle features and options

This system may not be available in the owned vehicle, e.g. due to the selected optional equipment, the national-market version or the option for later enabling and software updates. This also applies to individual functions of the system.

For information on whether a function is currently available in the vehicle or when the function can be installed in the vehicle, contact an authorized service center or another qualified service center or repair shop.

Additional information:

Vehicle equipment, refer to page 8.

Data protection

The Drive Recorder is permitted to record and evaluate video recordings in accordance with applicable regulations of the country in which the system is to be used. The user is responsible for the use of the system and compliance with respective applicable regulations.

The vehicle manufacturer recommends that you verify there are no statutory or regulatory restrictions on using the system in your region or country prior to initial use. In addition, the laws with respect to use of the system should be verified in regular



intervals, especially when borders are frequently crossed.

Other drivers of the vehicle must be informed about the system. In addition, you should inform others about the system when giving them the vehicle.

Functional requirements

The following functional requirements apply for the Drive Recorder:

- Standby or drive-ready state is switched on.
- The Drive Recorder is activated.
- The Privacy Policy has been accepted.
- The recording type has been selected.
- The recording duration has been selected.

The following functional requirements apply when using the theft alert:

- The theft notification was activated in the Data Protection menu or in the Drive Recorder menu.
- Data transfer is activated.
- The MINI app is installed on the mobile device.
- The MINI app is linked to the MINI Connected account.
- The Privacy Policy has been accepted.

Activating/deactivating the Drive Recorder

The Drive Recorder must be activated on the Interaction Unit before using the recording function for the first time.

1. Go to the Apps menu.
2. "All"
3. "Drive Recorder"
4. Accept the Privacy Policy.
5. "Settings"

6. "Allow recording"
7. Select the desired setting.

Recording functions

Starting/stopping an automatic recording

If the vehicle sensors detect an accident or theft, the Drive Recorder starts recording automatically and then saves this recording.

- In the event of an accident, the Drive Recorder saves recordings up to 30 seconds before and after storage is triggered.
- In the event of theft, the Drive Recorder saves recordings after being triggered. Recordings are stored depending on the setting selected for recording duration.

When the alarm system is triggered, a message is sent to the MINI app.

After saving the recording, the reduced quality video can be downloaded to a mobile device.

If the vehicle accelerates rapidly, an automatic recording may be taken.

Manual recording

Via the button

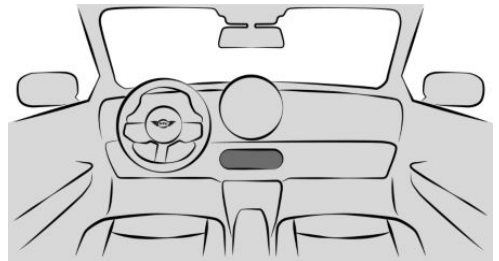

To start a manual recording with the Drive Recorder, press and hold the Park Assist key on the switch cluster.

ter.

Recordings are made for the set recording time or can be ended manually on the Interaction Unit.

Via the Interaction Unit

To start recording with Drive Recorder in the vehicle, go through the menu as follows: Apps menu / "All" / "Drive Recorder" / "Start recording" / "Vehicle".

Recordings are made for the set recording time and can be stopped manually by reselecting the menu item on the Interaction Unit.

The system saves recordings up to 30 seconds before and after storage is triggered.

Recording playback and administration

Video recordings saved by the Drive Recorder can be played, exported, and deleted.

For your own safety, video recordings are only shown on the Interaction Unit if the vehicle speed is below approx. 2 mph/3 km/h. Depending on national-market version, video recordings are only shown when the parking brake is applied or selector lever position P is engaged.

1. Go through the menu as follows: Apps menu / "All" / "Drive Recorder" / "Record -ings".
2. Select the desired recording.
3. If necessary, select the camera.

Settings

Recording type

1. To select the recording type for Drive Recorder, go through the menu as follows: Apps menu / "All" / "Drive Recorder" / "Settings".
2. Select the desired setting.

Recording time

1. To configure the recording time for Drive Recorder, go through the menu as follows: Apps menu / "All" / "Drive Recorder" / "Settings".
2. Select the desired setting.

Recording on a mobile device

General information

Depending on national-market version, the storable video length depends on the mobile device's available storage space.

Functional requirements

When recording on a mobile device, the following functional requirements apply for the Drive Recorder:

- The Privacy Policy has been accepted.
- The Drive Recorder is activated.

When sending recordings to a mobile device, the following functional requirements apply for the Drive Recorder:

- Depending on vehicle equipment, a mobile device can be paired with the vehicle over Wi-Fi and Bluetooth audio.
- The MINI app is installed on the mobile device.
- The MINI app is linked to the MINI Connected account.
- The MINI app is permitted to access your photo library.

Starting/ending recording

To start recording with Drive Recorder on a mobile device, go through the menu as follows: Apps menu / "All" / "Drive Recorder" / "Start recording" / "MINI App".

Recordings can be stopped manually by reselecting the menu item on the Interaction Unit.



Cameras

Various Drive Recorder cameras can be selected.

1. Go through the menu as follows: Apps menu / "All" / "Drive Recorder" / "Settings" / "Camera selection".
2. Select your desired camera.

System limits

In the event of a serious accident, the Drive Recorder may not be able to store recordings if the damage to the vehicle is too great or the power supply was interrupted.

In case of theft, the recording is only stored automatically when the anti-theft warning system has been triggered.

If the internet connection is weak or cannot be established, theft alerts and video downloads may be restricted or not available.

The quality of the Wi-Fi connection affects whether recordings can be saved on your smartphone. This function may be restricted or not available if the connection is weak.

Active Protection

Principle

Active Protection prepares occupants and the vehicle for a possible accident in critical driving situations.

Depending on vehicle equipment and national-market version, this system consists of various PreCrash functions.

Active Protection is used to detect certain critical driving situations that might lead to an accident. This includes the following critical driving situations:

- Emergency braking.
- Severe understeering.
- Severe oversteering.

General information

Certain functions of some vehicle systems can lead to Active Protection being triggered within their system limits:

- Automatic brake intervention by Forward Collision Mitigation.
- Brake power assistance provided by Forward Collision Mitigation.
- Detection of an impending rear collision by the Rear-collision warning.

Safety information

Warning

The system cannot serve as a substitute for the driver's personal judgment. Due to the system limits, critical situations might not be detected reliably or in time. There is a risk of accident. Adjust driving style to traffic conditions. Watch surrounding traffic closely and actively intervene where appropriate

PreCrash functions

Depending on vehicle equipment and requirements, Active Protection activates the following individual functions in critical driving situations:

- Automatic closing of the windows.
The windows remain open with a small gap.
- Automatic closing of the glass sunroof.
The sun protection is also closed.
- Automatic positioning of the backrest for the front passenger seat.

Systems can be returned to the desired settings following a critical driving situation without accident.

PostCrash iBrake

Principle

In certain accident situations, PostCrash iBrake can automatically bring the vehicle to a stop without any need for the driver to intervene. This can reduce the risk of a further collision.

After coming to a halt, the brake is released automatically.

The driver can intervene manually to brake the vehicle more sharply or cancel automatic braking with PostCrash iBrake.

Harder vehicle deceleration

In certain situations, it may be necessary to bring the vehicle to a stop more quickly than with PostCrash iBrake automatic braking.

To do this, quickly apply extra force to the brake. The brake pressure will then be higher than the brake pressure generated by automatic braking. Automatic braking with PostCrash iBrake is canceled.

Abort automatic braking

It may be necessary to cancel PostCrash iBrake automatic braking in certain situations, e.g., when making an evasive maneuver.

Automatic braking can be canceled by doing as follows:

- By depressing the brake pedal for slightly longer.
- By pressing the accelerator pedal for slightly longer.

Fatigue alert

Principle

The Fatigue Alert system can detect when the driver is less alert using various criteria.

The Fatigue Alert break recommendation function can detect driver fatigue, e.g., during long, monotonous trips. This function recommends taking a break as necessary. A notice is also displayed on the Interaction Unit.

The break recommendation can be configured on the Interaction Unit.

Safety information

Warning

The system cannot serve as a substitute for the driver's personal judgment in assessing one's physical state. An increasing lack of alertness or fatigue may not be detected or not be detected in time. There is a risk of accident, injury, and property damage. Make sure that the driver is rested and alert. Adjust driving style to traffic conditions.

Break recommendation

Function

After starting a journey, the break recommendation function is trained to the driver, enabling it to detect decreasing alertness or fatigue.

This process takes the following criteria into account:



- Personal driving style, e.g., steering behavior.
- Driving conditions, e.g., the time or duration of the drive.
- Depending on vehicle equipment, information from the Driver Attention Camera.

This function activates at speeds greater than approx. 43 mph/70 km/h and can also display a break recommendation.

Setting break recommendation

The Distraction Warning from the Fatigue Alert system can be turned on or off or configured.

1. Go through the menu as follows:
Apps menu / "Vehicle" / "Driving settings" / "Driver Assistance" / "Safety and warnings" / "Fatigue Alert".

2. Select the desired setting.

Despite this function being off, some driver assistance systems may issue break recommendations.

Display

If the Fatigue Alert system detects that the driver is paying less attention or has become fatigued, a message is displayed on the Interaction Unit recommending that the driver take a break.

During the display, various settings can be selected.

The system is reset approx. 45 minutes after parking the vehicle. A break recommendation can only be displayed again after this time has elapsed.

System limits

The Fatigue Alert system may be limited. If the system is limited, either no warning may be issued or an unwarranted warning may be issued.

The break recommendation function may be limited in the following situations:

- If the time is set incorrectly.
- At a predominantly driven speed below approx. 43 mph/70 km/h.
- With a sporty driving style such as during rapid acceleration or when cornering fast.
- In active driving situations such as when changing lanes frequently.
- When the road condition is poor.
- In the event of strong side winds.

Driver Attention Camera

Principle

The Driver Attention Camera is a camera on the instrument panel. The camera monitors the driver's activity and direction of view, depending on vehicle equipment.

The assistance systems help drivers by analyzing whether they are paying attention, e.g., by evaluating their head position and eyes.

Functional requirements

For full operability, make sure that the field of view of the Driver Attention Camera is not obstructed.

The steering wheel and driver's seat height must be adjusted so that the Driver Attention Camera is close to the upper rim of the steering wheel. This enables the Driver Attention Camera to record the driver's entire face.

Overview

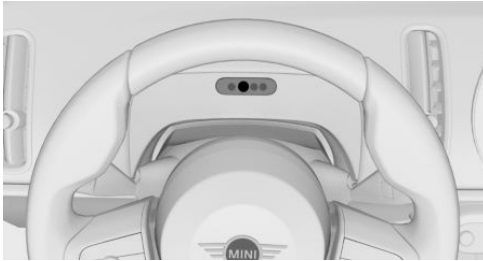

Depending on vehicle equipment, the instrument panel may have some infrared light sources. Depending on the light conditions, these light sources can be visible when the vehicle is in standby mode.

System limits

The Driver Attention Camera may not be fully operational in the following situations:

- When the Driver Attention Camera is covered by the steering wheel.
- When wearing sunglasses with high protection against infrared light.



Driving stability control systems

Vehicle features and options

This chapter describes model-specific equipment, systems, and functions that are currently available, or may become available in the future, even if they are not present in the vehicle.

Additional information:

Vehicle equipment, refer to page 8.

Antilock Braking System

Principle

The Antilock Braking System prevents locking of the wheels during the braking process.

The vehicle maintains its steerability even during emergency braking, which increases the active driving safety.

The Antilock Braking System activates automatically whenever drive-ready state is turned on.

Malfunction



The warning light illuminates on the Interaction Unit.



A Check Control message is displayed.

- The Antilock Braking System is not available.
- The ability to steer is restricted during full braking.

Have the vehicle checked immediately by an authorized service center or another qualified service center or repair shop.

Brake assistant

The brake assistant automatically applies maximum braking assistance when the brake pedal is depressed quickly. This reduces the braking distance to a minimum for full braking.

To make full use of braking assistance, do not reduce the pressure on the brake pedal during full braking.

Dynamic Stability Control

Principle

Dynamic Stability Control can be activated or deactivated via MINI Modes. Dynamic Stability Control helps keep your vehicle safely on the road in critical driving situations. The drive power is reduced depending on the situation, and wheels can be braked individually.

The Dynamic Stability Control will detect, e.g., the following unstable driving conditions:

- Skidding, which can lead to oversteering.
- Loss of adhesion of the front wheels, which can lead to understeering.

Safety information

Warning

The system cannot serve as a substitute for the driver's personal judgment in assessing the traffic situation. Based on the limits of the system, it cannot independently react to all traffic situations. There is a risk of accident, injury, and property

damage. Adjust driving style to traffic conditions. Watch the surrounding traffic situation closely, be ready to take over steering and braking at any time, and actively intervene where appropriate.

Warning

When driving with a roof load, e.g., roof bars, the vehicle's center of gravity is higher. This increases the risk of the vehicle tipping in critical driving situations. There is a risk of accident, injury, and property damage. Drive with roof load only with activated Dynamic Stability Control.

Overview





The MINI Modes switch is located on the switch cluster and labeled EXPERIENCE.

Activating/deactivating Dynamic Stability Control

If Dynamic Stability Control is deactivated, driving stability is restricted when accelerating and cornering.

To support driving stability, reactivate Dynamic Stability Control as soon as possible.

To activate/deactivate Dynamic Stability Control, proceed as follows:

-  Select Go Kart Mode using the MINI Modes switch on the switch cluster.
-  Tap the Settings icon on the Interaction Unit.
- Go through the menu as follows: "Driving dynamics" / "DSC OFF".

Dynamic Stability Control is deactivated.

Dynamic Stability Control reactivates automatically when changing to another drive mode.

Views on the Interaction Unit



If Dynamic Stability Control is deactivated, DSC OFF is shown on the Interaction Unit.



Dynamic Stability Control is deactivated when the indicator light illuminates.



When the warning light flashes, Dynamic Stability Control is regulating the driving and brake power. The vehicle is stabilized. Reduce the vehicle speed and adjust your driving style to the road conditions.



If the warning light illuminates, Dynamic Stability Control has failed or is initializing. Driving stabilization is restricted or has failed.

If the warning light illuminates continuously, have the vehicle checked immediately by an authorized service center or another qualified service center or repair shop.

Setting for increased driving dynamics

Principle

For a more dynamic driving experience, MINI Modes can be used to increase driving dynamics.

Dynamic Stability Control, and thus driving stability, are limited while accelerating and cornering.

Overview

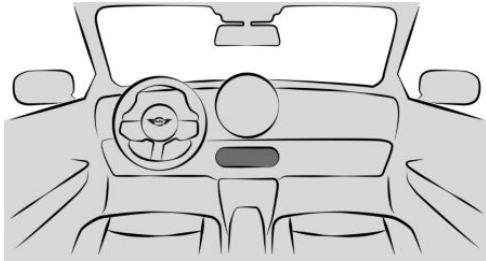



The MINI Modes switch is located on the switch cluster and labeled EXPERIENCE.

Functional requirement

To increase driving dynamics, Go Kart Mode must be selected via MINI Modes:

Activating/deactivating increased driving dynamics

To activate increased driving dynamics, proceed as follows:

1.  Select Go Kart Mode using the MINI Modes switch on the switch cluster.
2.  Tap the Settings icon on the Interaction Unit.
3. Go through the menu as follows: "Driving dynamics" / "SPORT PLUS".

Increased driving dynamics is activated.

Dynamic Stability Control automatically re-activates when changing to another drive mode.

Interaction Unit view



If increased driving dynamics is activated, the Dynamic Stability Control indicator light illuminates on the Interaction Unit.

Automatic program change

Increased driving dynamics deactivates automatically in the following situations, for example:

- When the Distance Control is activated.
- In case of a brake intervention by Forward Collision Mitigation. Deactivate Forward Collision Mitigation as necessary.
- If the suspension control system fails.
- The vehicle has a flat tire.

Additional information:

Forward Collision Mitigation with brake intervention, refer to page 180.



Drive-off support

Principle

Drive-off support provides the best possible traction when driving off in certain situations, e.g., on difficult surfaces like snow or sand.

This function ensures maximum drive power at low speeds with adapted driving stability.

Activating/deactivating the drive-off support

To activate drive-off support, go through the menu as follows: Apps menu / "Vehicle" / "Driving settings" / "Drivetrain and chassis" / "Activate drive-off support once".

Drive-off support remains on until it is deactivated or the driving mode is changed.

Display



If drive-off support is activated, the drive-off support indicator light illuminates on the Interaction Unit.

ALL4

ALL4 is the vehicle's all-wheel-drive system. The interplay between ALL4 and other suspension control systems, e.g., Dynamic Stability Control, further optimizes vehicle traction and driving dynamics.

ALL4 variably distributes the drive force to the front and rear axles as required by the driving situation and road conditions.

Hill Descent Control

Principle

Hill Descent Control is a downhill control feature for vehicles with all-wheel drive. This feature adjusts the vehicle speed on steep downhill gradients, e.g., when driving on unpaved roads.

When Hill Descent Control is on, the vehicle moves at the speed set by the driver, without the driver having to depress the brake pedal.

While Hill Descent Control is adjusting the speed, the system automatically distributes the brake power to the individual wheels. Driving stability and steerability are improved. If necessary, the Antilock Braking System prevents the wheels from locking.

Hill Descent Control can be enabled at speeds below approx. 25 mph/40 km/h.

Speeds can be set between approx. 2 mph/3 km/h and approx. 20 mph/30 km/h. While driving downhill, this system reduces the vehicle speed to the set value, as physically possible.

Drive in selector lever positions D, R or N for optimum system support.

Vehicle features and options

This system may not be available in the owned vehicle, e.g. due to the selected optional equipment, the national-market version or the option for later enabling and software updates. This also applies to individual functions of the system.

For information on whether a function is currently available in the vehicle or when the function can be installed in the vehicle, contact an authorized service center or another qualified service center or repair shop.

Additional information:



Vehicle equipment, refer to page 8.

Enabling/disabling Hill Descent Control

To activate/deactivate Hill Descent Control, go through the menu as follows: Apps menu / "Vehicle" / "Driving settings" / "Driver assistance" / "Hill Descent Control".

Hill Descent Control is automatically disabled at speeds above approx. 25 mph/40 km/h.

While Hill Descent Control is regulating the vehicle speed, the following functions are deactivated:

- Forward Collision Mitigation with Brake Intervention.
- The emergency braking function of Active Park Distance Control.

Additional information:

- Forward Collision Mitigation with brake intervention, refer to page 180.
- Active Park Distance Control, refer to page 265.

Display



The chosen set speed is displayed on the Interaction Unit together with the Hill Descent Control icon.

- The display illuminates green when the system is on. Hill Descent Control decelerates the vehicle.
- The display illuminates gray when the system is in standby.

Display in the Head-up display

The status of Hill Descent Control can also be shown on the Head-up display.

Increasing or decreasing vehicle speed

Using the rocker button for cruise control



On the left side of the steering wheel, repeatedly press the rocker button up or down until the desired speed is set.

- Press the rocker button up or down to gradually increase or decrease the set speed.
- Press the rocker button up/down and hold it until the desired speed is reached.

Using the brake pedal

While Hill Descent Control is adjusting the speed, the target speed set can be reduced by depressing the brake pedal.

Malfuction

If Hill Descent Control malfunctions, a Check Control message is displayed on the Interaction Unit.

Servotronic

Servotronic is a speed-dependent steering support.

The system provides the steering force with more support at low speeds than at higher ones. This makes it easier to park, for instance, and makes steering firmer when driving at faster speeds.

The steering force adapts to the drive mode to convey a firm, sporty feel or a comfortable steering response.



Driver assistance systems

Vehicle features and options

This chapter describes model-specific equipment, systems, and functions that are currently available, or may become available in the future, even if they are not present in the vehicle.

Additional information:

Vehicle equipment, refer to page 8.

Speed warning

Principle

The speed warning can be used to set a speed limit. A warning will be issued when this speed limit is exceeded.

General information

Another speed warning is given when the set speed limit is exceeded again after it has dropped by 3 mph/5 km/h.

Settings

The Speed Limit Warning can be activated or deactivated. In addition, the speed limit for the warning can be configured.

1. To configure the settings, go through the menu as follows: Apps menu / "Vehicle" / "Driving settings" / "Driver Assistance" / "Safety and warnings" / "Speed warning".
2. Select the desired setting.

Speed Limit Info

Speed Limit Info

Principle

Speed Limit Info uses a camera near the interior rearview mirror to detect road signs at the edge of the road as well as overhead sign posts.

Speed Limit Info shows the current speed limit on the Interaction Unit and, where applicable, Head-up display.

Speed Limit Info may also show speed limits that apply to routes that are not signposted if the navigation system has current map data.

General information

Traffic signs with extra icons are considered and compared with the vehicle's on-board data. Depending on the situation, traffic signs can either be displayed or ignored on the Interaction Unit and, where applicable, Head-up display.

For Speed Limit Info to function correctly, current map data for the country in which the vehicle is operated must be downloaded.

For information on the current map version and map updates, see Map update in the Navigation system chapter.

Without map data, the system is subject to certain technical limitations. Traffic signs with speed limitations are detected and displayed only. Speed limits due to entering towns/cities, highway signs, etc., are not displayed. Speed limits with extra traffic signs are always displayed.

Additional information:

- Owner's Manual for Navigation, Entertainment, and Communication, refer to page 6.

Safety information

Warning





The system cannot serve as a substitute for the driver's personal judgment in assessing the traffic situation. Based on the limits of the system, it cannot independently react to all traffic situations. There is a risk of accident, injury, and property damage. Adjust driving style to traffic conditions. Watch the surrounding traffic situation closely, be ready to take over steering and braking at any time, and actively intervene where appropriate.

Sensors

The system is controlled by a camera behind the windshield.

Display

Speed Limit Info

Icon	Description
	Current speed limit. Depending on the national-market version, it is possible to switch between the units of measurement.
	
	No data on current speed limit available.
	Speed Limit Info not available.

Warning signals

Depending on the settings, an acoustic signal sounds if the detected speed limit is exceeded or the speed limit changes. The display also flashes if the detected speed limit is exceeded.

Settings

Individual settings can be configured for Speed Limit Info, e.g., warnings issued if the speed is exceeded or the permissible maximum speed changes.

1. To configure the settings for Speed Limit Info, go through the menu as follows: Apps menu / "Vehicle" / "Driving settings" / "Driver Assistance" / "Driving" / "Speed Limit Assistant".
2. Select the desired setting.

System limits

System limits of the sensors

Additional information:

- Camera, refer to page 40.

Functional limitations

Speed Limit Info may be restricted and provide incorrect information in the following situations:

- Traffic signs are fully or partially concealed by objects, stickers, or paint.
- Traffic signs do not comply with the standard.
- In areas that are not included in the navigation system map data.
- If navigation system map data is invalid, outdated, or unavailable.
- When roads deviate from the navigation such as due to changes in road layout.
- When driving very close to the vehicle in front of you.



- When passing buses or trucks with traffic signs applied to them.
- In case of electronic traffic signs.
- When traffic signs that are valid for a parallel road are detected.
- In the presence of country-specific road signs or road layouts.

Speed control systems

Principle

The speed control systems provide assistance while driving, for example, by limiting your speed, maintaining your distance, or keeping your vehicle in its lane.

These systems are operated using the buttons on the steering wheel.

Speed control system information is displayed on the Interaction Unit.

General information

Depending on vehicle equipment, the speed control systems include the following individual systems:

- Cruise Control, refer to page 225.
- Distance Control, refer to page 228.
- Assisted Driving Mode, refer to page 234.
- Assisted Driving Mode Plus, refer to page 242.

Depending on the equipment and national-market version, the individual systems are enhanced with additional functions.

Some functions can be operated via voice control.

Additional information:

MINI Intelligent Personal Assistant, refer to page 55.





Safety information

Warning

The system cannot serve as a substitute for the driver's personal judgment in assessing the traffic situation. Based on the limits of the system, it cannot independently react to all traffic situations. There is a risk of accident, injury, and property damage. Adjust driving style to traffic conditions. Watch the surrounding traffic situation closely, be ready to take over steering and braking at any time, and actively intervene where appropriate.

Overview

Buttons on the steering wheel

Button	Function
	Turn last active speed control system on/off. Interrupt and continue speed control systems.
	Select the desired speed control system.
	Store current speed. Speed Limit Assistant: accept suggested speed manually.
	Set speed.

Turning on/selecting speed control systems

1.  To activate the speed control system, press the on/off button on the left side of the steering wheel. The Interac-



tion Unit contains a toolbar with available speed control systems.

2.  To select a different speed control system while this system is active, repeatedly press the MODE button on the left of the steering wheel until the desired system is displayed on the toolbar on the Interaction Unit.

The system is shown in white when the system can be activated.

The system is shown in green when it can be activated.

The system is grayed out if the system has failed or if the functional requirements are not met.

Icon	Speed control system
	Cruise control.
	Distance control.
	Assisted Driving Mode: Cruise Control with Distance Control, Steering Assistance with lane keeping.

Interrupting speed control systems automatically



Depending on the system, speed control systems are interrupted automatically, for instance in the following situations:

- When changing from selector lever position D to P, N, or R.
- While Dynamic Stability Control regulates driving stability.
- While Dynamic Stability Control is disabled.

- "SPORT PLUS": Upon activating the increased driving dynamics setting.
- When performing a manual braking process.

Interrupting speed control systems manually

Speed control systems can be stopped manually.

-  Press the on/off button on the left side of the steering wheel.
-  Press the MODE button on the left side of the steering wheel.

The speed control system has been stopped.

Continuing speed control systems

-  To resume the speed control system, press the on/off button on the left side of the steering wheel.

The speed control system will resume.

Switching off speed control systems

Speed control systems can be switched off manually.

-  To turn off the speed control system, press and hold the on/off button on the left side of the steering wheel until the indicators go out.

The speed control systems have been switched off.

Speed control systems switch off automatically when drive-ready state is switched off.

Adjusting speed values

The speeds for the speed control systems can be adjusted on the steering wheel.



On the left side of the steering wheel, repeatedly press the rocker button up or down until the desired value is set.

- Each time the rocker button is pressed to the resistance point, the set speed increases or decreases by 1 mph/1 km/h.
- Each time the rocker button is pressed past the resistance point, the set speed changes by a maximum of 5 mph/10 km/h.

Interaction Unit view

Displaying the set speed

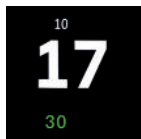

The speed set for the speed control system is shown below the speedometer. The color indicates the system status.

- The speed value illuminates green when a speed control system is activated.
- The speed value illuminates gray when the system is interrupted.
- If no value is displayed, the system turns off.

Notifications

Messages are displayed for some functions on the Interaction Unit in addition to the corresponding speed control system indicator lights.

1. To configure the notification scope, go through the menu as follows: Apps menu / "Vehicle" / "Driving settings" / "Driver Assistance" / "Driving" / "Notifications".
2. Select the desired setting.

Cruise Control

Principle

With the Cruise Control, the buttons on the left of the steering wheel can be used to adjust your set speed. The system maintains the set speed. The system accelerates and brakes automatically as needed.

Cruise control information is shown on the Interaction Unit.

General information

Cruise control can be activated starting from a vehicle speed of 20 mph/30 km/h.

Depending on the vehicle setting, the Cruise Control settings can change under certain conditions. For instance, the acceleration can change depending on the driving mode.

Safety information

Warning

The system cannot serve as a substitute for the driver's personal judgment in assessing the traffic situation. Based on the limits of the system, it cannot independently react to all traffic situations. There is a risk of accident, injury, and property damage. Adjust driving style to traffic conditions. Watch the surrounding traffic situation closely, be ready to take over steering and braking at any time, and actively intervene where appropriate.

Warning

The use of the system can lead to an increased risk of accidents in the following situations, for instance:

- On winding roads.
- With high traffic volume.
- On slippery roads, in fog, snow, or wet conditions, or on a loose road surface.





There is a risk of accident, injury, and property damage. Only use the system if driving at constant speed is possible.

Warning

The set speed can be incorrectly adjusted or called up by mistake. There is a risk of accident, injury, and property damage. Adjust the set speed to the traffic conditions. Watch surrounding traffic closely and actively intervene where appropriate

Overview

Buttons on the steering wheel



Button	Function
	Turn last active speed control system on/off. Interrupt and continue speed control systems.
	Select the desired speed control system.
	Store current speed. Speed Limit Assistant: accept suggested speed manually.
	Set speed.

Turning on the Cruise Control

Cruise Control can be switched on as follows:

For vehicles equipped with Distance Control: Change the Cruise Control mode to Cruise Control without Distance Control.

In vehicles without distance control: turn on the Cruise Control with the buttons on the steering wheel.

-  To switch on Cruise Control, press the on/off button on the left side of the steering wheel.
-  To switch on Cruise Control, press the MODE button on the left side of the steering wheel repeatedly until Cruise Control is selected.

Cruise control is active. The current speed is maintained and stored as desired speed.

The indicator lights on the Interaction Unit illuminate and the mark on the speedometer is set to the current speed.

The driving mode changes or Dynamic Stability Control activates when cruise control is switched on.

Additional information:

Distance Control, refer to page 228.

Turning the speed control system off/interrupting

The speed control system can be turned off or canceled automatically or manually.

Additional information:

Speed control systems, refer to page 223.

Adjusting the speed

Store/maintain speed

The speed can be maintained and stored using the buttons on the steering wheel.

 Press the rocker button on the left side of the steering wheel up or

down once while the system is stopped.

When cruise control is switched on, the current speed is maintained and saved as the desired speed.

The saved speed is shown on the speedometer.

If the Speed Limit Assistant is off, you can also save your current speed with the press of a button.

 Press the SET button on the left side of the steering wheel.

Changing the speed

The speed can be changed with the buttons on the steering wheel.

 On the left side of the steering wheel, repeatedly press the rocker button up or down until the desired speed is set.

If active, the displayed speed is stored and the vehicle reaches the stored speed when the road is clear.

The maximum speed that can be set depends on the vehicle.

Press rocker button to resistance point and hold: The vehicle accelerates or decelerates without the accelerator pedal being pressed.

After the rocker button is released, the vehicle maintains the final speed achieved. Pressing the switch beyond the resistance point causes the vehicle to accelerate more rapidly.

Continuing cruise control

At the stored speed

Warning

The set speed can be incorrectly adjusted or called up by mistake. There is a risk of accident, injury, and property damage. Adjust the set speed to the traffic conditions. Watch surrounding traffic closely and actively intervene where appropriate

An interrupted cruise control can be continued by calling up the stored speed. The difference between the current speed and the stored speed should be as little as possible.

 To resume Cruise Control while the system is stopped, press the on/off button on the left side of the steering wheel.

Cruise control is continued with the stored values.

In the following cases, the stored speed value is deleted and cannot be called up again:

- When the system is switched off.
- When drive-ready state is switched off.

At the current speed

 To continue using the cruise control at the current speed, press the rocker button up or down on the left side of the steering wheel.

Speed Limit Assistant: at the suggested speed

 To apply the speed suggested by the Speed Limit Assistant to the Cruise Control, press the SET button on the left of the steering wheel.

Views on the Interaction Unit

Displaying the set speed

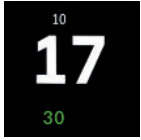

The speed set for the speed control system is shown below the speedometer. The color indicates the system status.

- The speed value illuminates green when a speed control system is activated.
- The speed value illuminates gray when the system is interrupted.
- If no value is displayed, the system turns off.

Indicator light



The cruise control status is also given by the indicator light on the Interaction Unit. The indicator light illuminates green when the system is activated.

Displays in the Head-up display

Depending on vehicle equipment, some speed control system information can also be displayed on the Head-up display.

System limits

Depending on the drive mode or drive power, the vehicle may exceed or drop below the set desired speed in some situations, e.g., when driving uphill or downhill.

Do not use Cruise Control when towing.

Distance control

Principle

With the distance control, a distance to a vehicle driving ahead can be adjusted in addition to the Cruise Control.

The distance can be adjusted at several levels. For safety reasons, it depends on the respective speed.

The system maintains the set speed on clear roads. The vehicle accelerates or brakes automatically.

If a vehicle is driving ahead of you, the system adjusts the speed of the vehicle so that the set distance to the vehicle ahead is maintained. The speed is adjusted as far as the given situation allows.

Distance Control is operated using the buttons on the left of the steering wheel. The distance is set using the Interaction Unit.

Distance Control information is shown on the Interaction Unit.

General information

If the preceding vehicle brakes to a standstill and drives off again shortly afterward, Distance Control is capable of detecting this as far as given conditions allow.

Otherwise, drive off independently such as by stepping on the accelerator pedal or by pressing the button for the speed setting on the steering wheel.

Safety information

Warning

The system cannot serve as a substitute for the driver's personal judgment in assessing the traffic situation. Based on the limits of the system, it cannot independently react to all traffic situations. There is a risk of accident, injury, and property

damage. Adjust driving style to traffic conditions. Watch the surrounding traffic situation closely, be ready to take over steering and braking at any time, and actively intervene where appropriate.

Warning

An unsecured vehicle can begin to move and possibly roll away. There is a risk of accident, injury, and property damage. Before leaving the vehicle, secure the vehicle against rolling away.

In order to ensure that the vehicle is secured against rolling away, follow the following:

- Set the parking brake.
- Automatic transmission: Make sure that selector lever position P is engaged.
- On uphill grades or on downhill slopes, turn the front wheels in the direction of the curb.
- On uphill grades or on downhill slopes, also secure the vehicle, for instance with a wheel chock.

Warning

The set speed can be incorrectly adjusted or called up by mistake. There is a risk of accident, injury, and property damage. Adjust the set speed to the traffic conditions. Watch surrounding traffic closely and actively intervene where appropriate

Warning





Risk of accident is greater when there is a high speed differential to other vehicles, for instance in the following situations:

- When approaching a slowly moving vehicle at speed.
- Vehicle suddenly swerving into own lane.
- When approaching stationary vehicles at speed.

There is a risk of injury or danger to life. Watch surrounding traffic closely and actively intervene where appropriate

Overview

Buttons on the steering wheel

Button	Function
	Turn last active speed control system on/off.
	Interrupt and continue speed control systems.
	Select the desired speed control system.
	Store current speed. Speed Limit Assistant: accept suggested speed manually.
	Set speed.

Sensors

Distance Control is controlled by the following sensors:

- Camera behind the windshield.
- Front radar sensor.

Additional information:

Sensors of the vehicle, refer to page 40.

Application range

Distance Control is best when used on well-maintained roads.





The maximum speed that can be set is limited and depends, for example, on the vehicle and the vehicle equipment.

The system can also be activated when stationary.

Do not use Cruise Control and Distance Control when towing.

Turning on Cruise Control with Distance Control

Switch on Cruise Control with Distance Control using the buttons on the steering wheel.

-  To switch on Cruise Control with Distance Control, press the on/off button on the left side of the steering wheel.
-  If necessary, press the MODE button on the left side of the steering wheel repeatedly until Distance Control is selected.

Cruise Control with Distance Control is active. The current speed is maintained and stored as desired speed.

The selected distance to a vehicle driving ahead is maintained.

The indicator lights on the Interaction Unit illuminate and the mark on the speedometer is set to the current speed.

The driving mode changes or Dynamic Stability Control activates when Distance Control is switched on.

Adjusting the speed

The speed can be set with the buttons on the steering wheel.

Additional information:

Cruise control, refer to page [225](#).

Interrupting Cruise Control with Distance Control automatically

Cruise Control with Distance Control is interrupted automatically in the following situations, for example:

- When performing a manual braking process.
- When selector lever position D is disengaged.
- While Dynamic Stability Control is disabled.
- "SPORT PLUS": When the setting for enhanced driving dynamics is enabled.
- While Dynamic Stability Control regulates driving stability.
- When the driver's seat belt and driver's door are opened.
- If the system has not detected objects for an extended period, for instance on a road with very little traffic without curb or shoulder markings.
- If the detection range of the radar is impaired, for instance by contamination or heavy precipitation.
- After a longer stationary period when the vehicle has been braked to a stop by the system.

Turning the speed control system off/interrupting

The speed control system can be turned off or canceled automatically or manually.

Additional information:

Speed control systems, refer to page [223](#).

Continuing cruise control while driving

Warning

The set speed can be incorrectly adjusted or called up by mistake. There is a risk of accident, injury, and property damage. Adjust the set speed to the traffic conditions. Watch surrounding traffic closely and actively intervene where appropriate

An interrupted cruise control can be continued by calling up the stored speed. The difference between the current speed and the stored speed should be as little as possible.

Additional information:

Cruise control, refer to page [225](#).

Continuing cruise control while vehicle is stationary

If the cruise control is stopped, the driver may need to confirm their intention to drive off in certain situations.

The displays show the following:

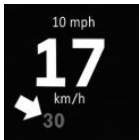

The speed set for the speed control system is shown in gray below the speedometer.



The indicator light illuminates green.

Cruise control can be continued as follows:

- Pressing the accelerator pedal.



- Press the rocker button on the left side of the steering wheel.



- Press the SET button on the left side of the steering wheel.

Distance

Safety information

Warning

The system cannot serve as a substitute for the driver's personal judgment. Due to the system limits, deceleration can be late. There is a risk of accidents and risk of property damage. Be aware of the surrounding traffic situation at all times. Adjust the distance to the traffic and weather conditions and maintain the prescribed safety distance, possibly by braking.

Adjusting the distance

1. To adjust the distance, go through the menu as follows: Apps menu / "Vehicle" / "Driving settings" / "Driver Assistance" / "Driving" / "Distance control" / "Distance".
2. Select the desired setting.

Automatic adaptation of the distance

Depending on vehicle equipment and national-market version, Distance Control can be configured to automatically adjust the distance to the preceding vehicle within the set distance. The system analyzes the traffic situation and ambient conditions, e.g., poor visibility.

To have the distance adjusted automatically, go through the menu as follows: Apps menu / "Vehicle" / "Driving settings" / "Driver Assistance" / "Driving" / "Distance control" / "Situational distance control".

Changing between Cruise Control with/without Distance Control

Safety information

Warning

The system does not react to traffic driving ahead of you, but instead maintains the stored speed. There is a risk of accident, injury, and property damage. Adjust the set speed to the traffic conditions and brake as needed.

Changing over the Cruise Control mode

To switch between cruise control with/without Distance Control, go through the menu as follows: Apps menu / "Vehicle" / "Driving settings" / "Driver Assistance" / "Driving" / "Distance control" / "Switch to Cruise Control".

The setting is reset when the vehicle is parked.

Views on the Interaction Unit



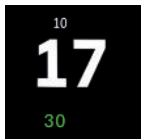

Displaying the set speed



The speed set for the speed control system is shown below the speedometer. The color indicates the system status.

- The speed value illuminates green when a speed control system is activated.
- The speed value illuminates gray when the system is interrupted.
- If no value is displayed, the system turns off.

Indicator lights and warning lights

Icon	Description
	Indicator light illuminates white: No Distance Control because accelerator pedal is being pressed.
	Indicator light illuminates green: Vehicle has been detected ahead of you. The vehicle icon goes out if no vehicle has been detected ahead of you. Indicator light flashes green: Preceding vehicle has driven off.
	Indicator light flashes gray: Conditions are not adequate for the system to work. The system was deactivated but applies the brakes until you actively resume control by pressing on the brake pedal or accelerator pedal.
	Warning light flashes red and acoustic signal sounds: Brake and make an evasive maneuver, if necessary.

Assisted View

Depending on vehicle equipment and national-market version, in Assisted View, Distance Control information is shown in the central display area on the Interaction Unit.

Additional information:

Assisted View, refer to page [157](#).



Displays in the Head-up display

Set speed

Depending on vehicle equipment, some speed control system information can also be displayed on the Head-up display.

Distance information



The distance information icon appears when the distance from the preceding vehicle is too short.

The distance information is active in the following situations:

- Cruise Control with Distance Control is switched off.
- The view on the Head-up display is selected.
- Distance to preceding vehicle is too short.
- Vehicle speed is greater than approx. 40 mph/70 km/h.

Additional information:

Head-up display, refer to page [143](#).

System limits

System limits of the sensors

Distance Control is subject to the system limits of the sensors.

Additional information:

- Cameras, refer to page [40](#).
- Radar sensors, refer to page [41](#).

Detection range

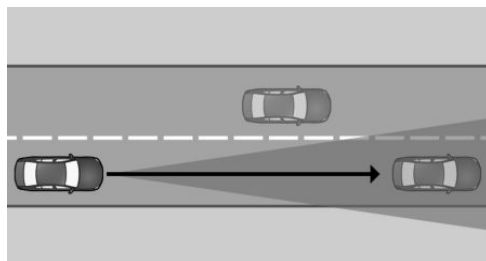

The vehicle sensors detect the traffic situation in their detection range.

The sensor detection capability and automatic braking power are limited.

For instance, two-wheeled vehicles may not be detected.

Deceleration

Distance Control does not decelerate in the following situations:

- For pedestrians or similarly slow-moving road users.
- For cross traffic.
- For oncoming traffic.

Merging vehicles

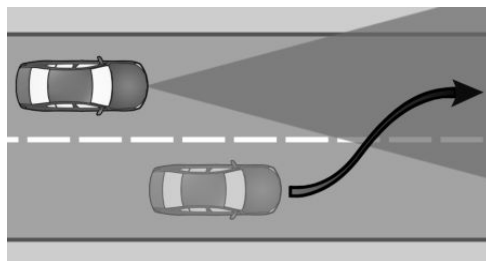

Distance Control may not be able automatically restore your chosen distance if a preceding vehicle suddenly cuts into your lane. It may not be possible to restore the selected distance in certain situations, including if you are driving significantly faster than vehicles driving ahead of you, for in-

stance when rapidly approaching a truck. When a vehicle has been detected ahead of you, the system requests that the driver intervene by braking and making an evasive maneuver, if needed.

Cornering

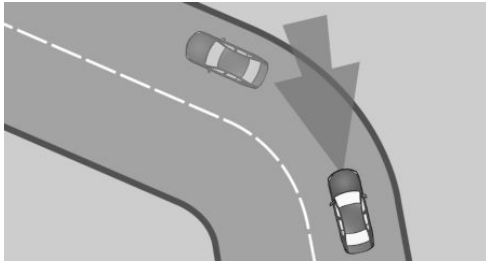

When Distance Control is on, if your set speed is too high for a bend, your vehicle will be slowed slightly in the bend. Because curves may not be anticipated in advance, drive into a curve at an appropriate speed. Distance Control has a limited detection range. Situations can arise in tight curves where a vehicle driving ahead will not be detected or will be detected very late.

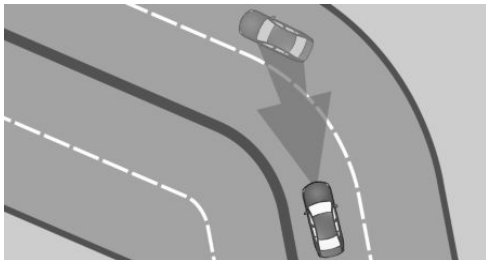

When you approach a curve the system may briefly report vehicles in the next lane due to the bend of the curve. If the system decelerates you may compensate for it by briefly accelerating. After releasing the accelerator pedal the system is reactivated and controls speed independently.

Driving off

Your vehicle cannot drive off automatically using Distance Control in the following situations, for example:

- On steep uphill grades.
- In front of bumps in the road.
- With a heavy trailer.

In these cases, step on the accelerator pedal.

Weather

Under unfavorable weather or light conditions, Distance Control may be limited in the following ways:

- Poorer vehicle detection.
- Short-term interruptions for vehicles that are already recognized.

Drive attentively, and react to the current surrounding traffic situation. If necessary, intervene actively, for instance by braking, steering or making an evasive maneuver.

Drive power

Depending on the drive mode or drive power, the vehicle may exceed or drop below the set desired speed in some situations, e.g., when driving uphill or downhill.

Assisted Driving Mode

Principle

Assisted Driving Mode enhances Distance Control with Steering Assistance and lane keeping. The system assists the driver in keeping the vehicle within the lane. For this purpose, the system executes supporting steering movements, for instance when cornering.

Assisted Driving Mode is operated using the buttons on the steering wheel.



Depending on vehicle speed, Assisted Driving Mode orients itself using the lane markings or preceding vehicles.

Sensors in the steering wheel detect whether the steering wheel is being touched.

Depending on vehicle equipment and national-market version, the Driver Attention Camera on the instrument panel monitors whether the driver is paying attention.

System information is given in the Interaction Unit views and indicated the steering wheel LEDs.

If a lane boundary is crossed, the system issues a warning by vibrating the steering wheel. The steering wheel vibration intensity can be adjusted.

Safety information

Warning

The system cannot serve as a substitute for the driver's personal judgment in assessing the traffic situation. Based on the limits of the system, it cannot independently react to all traffic situations. There is a risk of accident, injury, and property damage. Adjust driving style to traffic conditions. Watch the surrounding traffic situation closely, be ready to take over steering and braking at any time, and actively intervene where appropriate.





The Cruise Control and Distance Control alerts also apply.

Additional information:

- Cruise control, refer to page [225](#).
- Distance Control, refer to page [228](#).

Overview

Buttons on the steering wheel

Button	Function
	Turn last active speed control system on/off. Interrupt and continue speed control systems.
	Select the desired speed control system.
	Store current speed. Speed Limit Assistant: accept suggested speed manually.
	Set speed.

Sensors

Assisted Driving Mode is controlled by the following sensors:

- Camera behind the windshield.
- Front radar sensor.
- Depending on vehicle equipment, via the front, side radar sensors.
- Depending on vehicle equipment, via the rear, side radar sensors.
- The sensors in the steering wheel.
- Depending on vehicle equipment and national-market version, the Driver Attention Camera on the instrument panel.

Additional information:

- Sensors of the vehicle, refer to page [40](#).
- Driver Attention Camera, refer to page [214](#).

Functional requirements

The following functional requirements apply for Assisted Driving Mode:





- Depending on vehicle equipment, the speed must be below 130 mph/210 km/h or 110 mph/180 km/h.
- The lane is sufficiently wide.
- Hands are on the steering wheel rim.
- The bend radius is sufficiently large.
- The vehicle is driving in the center of the lane.
- The sensor system calibration process is complete.
- Distance Control is active.
- The seat belt on the driver's side is fastened.
- Forward Collision Mitigation is active.
- The side-collision warning must be active, depending on vehicle equipment.
- If the vehicle is equipped with a trailer hitch, use the Interaction Unit to configure the settings and specify whether the vehicle is towing a trailer or rear carrier, respectively.

Additional information:

Driving with trailer or rear carrier, refer to page 320.

Switching on Assisted Driving Mode

1.  To switch Assisted Driving Mode on, press the on/off button on the left side of the steering wheel.
2.  If necessary, press the MODE button on the left side of the steering wheel until Assisted Driving Mode is selected on the Interaction Unit toolbar.

System activates automatically as soon as all function conditions are fulfilled.

The status of Assisted Driving Mode is displayed on the Interaction Unit.



The indicator light illuminates gray when the system is ready and not performing any steering movement.



The indicator light illuminates green when the system is activated.

When this system is on, Forward Collision Mitigation and, depending on vehicle equipment, the Side Collision Warning activate.

Stopping Assisted Driving Mode automatically

Assisted Driving Mode automatically interrupts steering support in the following situations, for example:





- Depending on vehicle equipment: at speeds greater than 130 mph/210 km/h or 110 mph/180 km/h.
- After releasing the steering wheel.
- With a strong steering intervention.
- When leaving own lane.
- When the turn signal is switched on or, depending on the vehicle equipment, when the driver turns the steering wheel while the turn signal is switched on.
- Lane is too narrow.
- If a lane boundary is not detected and there is no vehicle driving in front.
- The Cruise Control with Distance Control is interrupted.
- The seat belt on the driver's side is unfastened.





The indicator light illuminates gray when the system is ready and not performing any steering movement.

System activates automatically as soon as all function conditions are fulfilled.

Views on the Interaction Unit

Icon	Description
	Indicator light illuminates gray: The system is ready.
	Indicator light illuminates green: The system is activated. The system supports the driver in keeping the vehicle within the lane.
	Warning light flashes yellow and steering wheel vibrates: A lane boundary has been crossed.
	Warning light illuminates yellow and acoustic signal sounds: System interruption is imminent.
	Warning light flashes red and acoustic signal sounds: The system is switched off or will be interrupted very soon.

Icon	Description
	Warning light illuminates yellow: Hands are not grasping the steering wheel. The system is still active. Grab the steering wheel with your hands.
	Warning light illuminates red, acoustic signal sounds: The hands are not on the steering wheel or, depending on the vehicle equipment and national-market version, the driver's line of sight is not directed at the surrounding traffic. System interruption is imminent.
	The system reduces the speed to a standstill if applicable. It is possible that the system will not execute any supporting steering movements. Immediately grasp the steering wheel with your hands and pay attention to the surrounding traffic.

Depending on vehicle equipment and national-market version, a Check Control message is displayed on the instrument panel if the Driver Attention Camera detects that the driver is inattentive.

Depending on vehicle equipment and national-market version, in Assisted View, Assisted Driving Mode information is shown in the central display area on the Interaction Unit.

Additional information:

Assisted View, refer to page [157](#).

Displays on the steering wheel



Similar to the displays for Assisted Driving Mode on the Interaction Unit, the two LEDs above the keypads on the steering wheel illuminate.

1. To turn the steering wheel displays on/off, go through the menu as follows: Apps menu / "Vehicle" / "Driving settings" / "Driver Assistance" / "Feedback via steering wheel" / "Light elements".
2. Select the desired setting.

Displays in the Head-up display

Depending on vehicle equipment, Assisted Driving Mode information can also be shown on the Head-up display.

Setting the intensity of the steering wheel vibration

1. To adjust the steering wheel vibration intensity, go through the menu as follows: Apps menu / "Vehicle" / "Driving settings" / "Driver Assistance" / "Feedback via steering wheel" / "Vibration intensity".
2. Select the desired setting.

This setting is applied to all collision warning systems.

System limits

General information

Assisted Driving Mode cannot be activated or used meaningfully in certain situations, e.g., when towing a trailer.

Safety information

Warning

Because of system limitations, this system may either not respond, or respond too late, incorrectly, or without cause. There is a risk of accident, injury, and property damage. Actively intervene as warranted. Refer to the information in this Owner's Manual regarding the scope of the system's operation and limitations.

The Cruise Control and Distance Control alerts also apply.

Additional information:

- Cruise control, refer to page 225.
- Distance Control, refer to page 228.

System limits of the sensors

Assisted Driving Mode is subject to the system limits of the sensors.

Additional information:

- Cameras, refer to page 40.
- Radar sensors, refer to page 41.
- Driver Attention Camera, refer to page 214.

Hands on the steering wheel

The sensors cannot detect hand-steering wheel contact in the following situations:

- Driving with gloves.
- Protective covers on the steering wheel.

Weather

With unfavorable weather or light conditions, Assisted Driving Mode may be limited as follows:

- Poorer recognition of vehicles and lane boundaries.
- Short-term interruptions in case of already detected vehicles and lane boundaries.

Drive attentively, and react to the current surrounding traffic situation. If necessary, intervene actively, for instance by braking, steering or making an evasive maneuver.

Lane Change Assistant

Principle

The Lane Change Assistant also performs slight steering interventions to assist the driver when changing lanes on multilane roads.

The Lane Change Assistant is turned on/off using the Interaction Unit and operated using the turn signal lever.

System information is shown on the Interaction Unit.

General information

The Lane Change Assistant uses the Assisted Driving Mode sensors.

Safety information

Warning

The system cannot serve as a substitute for the driver's personal judgment in assessing the traffic situation. Based on the limits of the system, it cannot independently react to all traffic situations. There is a risk of accident, injury, and property damage. Adjust driving style to traffic con-

ditions. Watch the surrounding traffic situation closely, be ready to take over steering and braking at any time, and actively intervene where appropriate.

Federal, state, or local laws may differ, and the use of this function may be prohibited or limited. Before use, check federal, state, and local laws.

The Assisted Driving Mode alerts also apply.

Additional information:

Assisted Driving Mode, refer to page [234](#).

Functional requirements

The following functional requirements apply to the Lane Change Assistant:

- The functional requirements for Assisted Driving Mode have been met.
- Driving on a highway-like road without pedestrians or cyclists. The road is also structurally separated from oncoming traffic, e.g., guard rails.
- A vehicle has been detected at a sufficient distance behind your own vehicle since beginning the drive.
- Crossable lane boundaries are detected.
- Vehicle speed is max. approx. 110 mph/180 km/h.
- The minimum speed is country-specific.
- If the vehicle is equipped with a trailer hitch, use the Interaction Unit to configure the settings and specify whether the vehicle is towing a trailer or rear carrier, respectively.

Additional information:

- Assisted Driving Mode, refer to page [234](#).
- Driving with trailer or rear carrier, refer to page [320](#).

Turning the Lane Change Assistant on/off

To turn the Lane Change Assistant on/off, go through the menu as follows: Apps menu / "Vehicle" / "Driving settings" / "Driver Assistance" / "Driving" / "Lane Change Assistant" / "Lane Change Assistant".

Changing lanes

1. Ensure that the traffic situation permits changing lanes.
2. To change lanes with Lane Change Assistant, press the turn signal lever in the desired direction to the resistance point. Depending on the vehicle equipment, the turn signal lever can also be pressed beyond the resistance point.

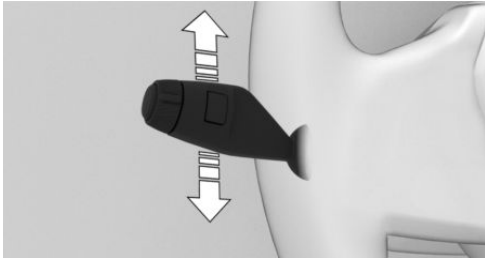



Supporting steering movement in the desired direction can be felt a short time later.

After the lane change, the system helps keep the vehicle in the new lane.

The lane change can be canceled by steering movement into the opposite direction or by operating the turn signal in the opposite direction.

Views on the Interaction Unit

Icon	Description
	Steering wheel icon and lane change arrow icon are green: The system performs a lane change in the arrow direction.
	Steering wheel icon is green and line for lane marking on respective side is gray: The system detected the lane change request. Lane change not currently possible.

Depending on vehicle equipment and national-market version, in Assisted View, Lane Change Assistant information is shown in the central display area on the Interaction Unit.

Additional information:

Assisted View, refer to page [157](#).

System limits

The limits of the Assisted Driving Mode system apply.

Additional information:

Assisted Driving Mode, refer to page [234](#).

Lane change with active guidance

Principle

Lane change with active guidance assists the driver when lane changes are necessary to reach a destination. A notice is also displayed on the Interaction Unit. In addition, a slight jerk can be felt on the steering wheel.

This function is turned on/off using the Interaction Unit.

General information

When route guidance is active, the Lane Change function uses the Assisted Driving Mode sensors.

Safety information

Warning

The system cannot serve as a substitute for the driver's personal judgment in assessing the traffic situation. Based on the limits of the system, it cannot independently react to all traffic situations. There is a risk of accident, injury, and property damage. Adjust driving style to traffic conditions. Watch the surrounding traffic situation closely, be ready to take over steering and braking at any time, and actively intervene where appropriate.

The Cruise Control, Distance Control, and Assisted Driving alerts also apply.

Additional information:

- Cruise control, refer to page 225.
- Distance Control, refer to page 228.
- Assisted Driving Mode, refer to page 234.

Functional requirements

The following functional requirements apply for lane changes when destination guidance is active:

- Cruise Control and Distance Control are activated.
- Driving on a highway or highway-like road.
- A situation-dependent minimum speed has been reached.
- The system detects a sufficiently large gap in traffic in the adjacent lane.

- A crossable lane boundary on the side of the desired lane change is detected.
- Destination guidance is active on the navigation system.

The function is not available when using navigation software via Apple CarPlay or Android Auto.

- The function must be available in the country in which the vehicle is driven.
- The Driver Attention Camera on the instrument panel detects whether the driver is paying attention to surrounding traffic.
- If the vehicle is equipped with a trailer hitch, use the Interaction Unit to configure the settings and specify whether the vehicle is towing a trailer or rear carrier, respectively.

Additional information:

Driving with trailer or rear carrier, refer to page 320.

Switching lane change on/off with active destination guidance

To turn the Lane Change Assistant on/off while guidance is on, go through the menu as follows: Apps menu / "Vehicle" / "Driving settings" / "Driver Assistance" / "Driving" / "Lane Guiding with Navigation" / "Lane Guiding with Navigation".

Switching the steering wheel jerk on/off

To enable/disable the steering wheel jerk for Lane Change Assistant, go through the menu as follows: Apps menu / "Vehicle" / "Driving settings" / "Driver Assistance" / "Driving" / "Lane Guiding with Navigation" / "Steering wheel impulse".

Changing lanes

If it is necessary to change lanes in order to reach a navigation destination, a corre-

sponding notice is displayed on the Interaction Unit. In addition, a slight jerk can be felt on the steering wheel.



To change lanes, follow the instructions on the Interaction Unit.

1.  The system detects a suitable gap in the flow of traffic in the adjacent lane. An icon with a green checkmark is displayed on the Interaction Unit. The system prepares for the lane change.
2. When a suitable gap is detected, the speed is adapted so that the vehicle remains level with the opening.
3. A Check Control message indicates a lane change suggestion.
4. When the traffic situation permits a lane change, the driver can steer the vehicle into the next lane.

If your vehicle is equipped with the Lane Change Assistant, the Lane Change Assistant can be started by operating the turn signal after the Check Control message appears.

5. If necessary, the system automatically starts additional lane changes.

Interaction Unit view

Icon	Function
	Indicates a necessary lane change. The icon varies depending on the traffic situation.
	A green checkmark on the icon indicates that the function is active. A red cross on the icon indicates that the system cannot assist with the lane change.

Depending on vehicle equipment and national-market version, in Assisted View, the

traffic situation is shown in the central display area on the Interaction Unit.

Additional information:

Assisted View, refer to page 157.

System limits

The limits of the Cruise Control, Distance Control, and Assisted Driving Mode systems, and Driver Attention Camera apply to the lane change function with active guidance.

Additional information:

- Cruise control, refer to page 225.
- Distance Control, refer to page 228.
- Assisted Driving Mode, refer to page 234.
- Driver Attention Camera, refer to page 214.

Assisted Driving Mode Plus

Principle

Assisted Driving Mode Plus provides assistance with guiding the vehicle in traffic jams on select highways.

The system increases driving comfort in suitable driving situations.

Sensors in the steering wheel detect whether the steering wheel is being touched.

Assisted Driving Mode Plus is turned on/off using the Interaction Unit.

System information is given in the Interaction Unit views and indicated the steering wheel LEDs.

Safety information

Warning

The system cannot serve as a substitute for the driver's personal judgment in assessing the traffic situation. Based on the limits of the system, it cannot independently react to all traffic situations. There is a risk of accident, injury, and property damage. Adjust driving style to traffic conditions. Watch the surrounding traffic situation closely, be ready to take over steering and braking at any time, and actively intervene where appropriate.

Warning

This system is only intended for use on roads with structural separation from oncoming traffic, e.g., highways. Because of the system limits, the system can also remain active on roads without structural separations and may not react as expected. There is a risk of accident, injury, and property damage. Deactivate the system if it is enabled on roads without structural separations.

Federal, state, or local laws may differ, and the use of this function may be prohibited or limited. Before use, check federal, state, and local laws.

The Assisted Driving Mode alerts also apply.

Additional information:

Assisted Driving Mode, refer to page [234](#).

Overview

Sensors

Assisted Driving Mode Plus is controlled by the following sensors:

- Camera behind the windshield.
- Front radar sensor.
- Side radar sensors, front.
- Side radar sensors, rear.
- The sensors in the steering wheel.
- Driver Attention Camera.

Additional information:

Sensors of the vehicle, refer to page [40](#).

Functional requirements

The following functional requirements apply to Assisted Driving Mode Plus:

- Assisted Driving Mode Plus must be available in the country in which the vehicle is driven.
- The functional requirements for Assisted Driving Mode have been met. Assisted Driving Mode is active and the LED displays on the steering wheel are switched on.
- Driving on a highway-like road without pedestrians or cyclists. The road is also structurally separated from oncoming traffic, e.g., guard rails.
- Lane boundaries are detected.
- The lane is sufficiently wide.
- The bend radius is sufficiently large.
- The navigation system must clearly identify the road and vehicle position.
- This function must be available on the road on which the vehicle is driving.
- Do not allow antennas on the roof to become covered, e.g., by roof loads or snow.
- The Driver Attention Camera on the instrument panel detects whether the driver is paying attention to surrounding traffic.
- A vehicle has been detected ahead of you.



- Vehicle speed must be less than approx. 40 mph/60 km/h.
- If the vehicle is equipped with a trailer hitch, use the Interaction Unit to configure the settings and specify whether the vehicle is towing a trailer or rear carrier, respectively.

Additional information:

- Assisted Driving Mode, refer to page [234](#).
- Driving with trailer or rear carrier, refer to page [320](#).

Switching Assisted Driving Mode Plus on/off

To turn Assisted Driving Mode Plus on/off, go through the menu as follows: Apps menu / "Vehicle" / "Driving settings" / "Driver Assistance" / "Driving" / "Assisted Driving Plus" / "Assisted Driving Plus".

Assisted Driving Mode Plus is automatically offered when Assisted Driving Mode is active and all functional requirements for Assisted Driving Mode Plus have been met.

To activate this function, remove your hands from the steering wheel. Remain ready to steer and brake at all times.

Two green LED lights are illuminated on the steering wheel.



The indicator light on the Interaction Unit is shown in green.

The system begins to assist the driver with vehicle control.

When the system is switched on, the following functions are enabled:

- Forward Collision Mitigation.
- Side collision mitigation.

Views on the Interaction Unit

Icon	Description
	Indicator light green: system is active.
	Indicator light is white: System can be used.

Displays on the steering wheel



The two LEDs above the keypads on the steering wheel illuminate depending on the situation.

- The LEDs on the steering wheel illuminate green when Assisted Driving Mode Plus is active.
- The LEDs on the steering wheel illuminate yellow when the system is interrupted.
Grab the steering wheel with your hands.
- The LEDs on the steering wheel illuminate red when the system is deactivated.
Grab the steering wheel immediately with your hands.

Additional information:

Assisted Driving Mode, refer to page [234](#).

Displays in the Head-up display

Depending on vehicle equipment, Assisted Driving Mode Plus information can also be shown on the Head-up display.

System limits

The system limits of the following systems apply:

- Assisted Driving Mode.
- Driver Attention Camera.
- Sensors of the vehicle.

Additional information:

- Assisted Driving Mode, refer to page 234.
- Driver Attention Camera, refer to page 214.
- Sensors of the vehicle, refer to page 40.

Speed Limit Assistant

Principle

Speed Limit Assistant supports driving at the speed limit. You can have speeds suggested by the Speed Limit Assistant adopted by your vehicle's speed control systems.

The Speed Limit Assistant is turned on/off using the Interaction Unit and operated using the buttons on the steering wheel.

Suggested speeds can be adjusted by entering tolerances.

System information is shown on the Interaction Unit.

General information

When the systems in the vehicle, e.g., Speed Limit Info, detect a change of the speed limit, this new speed value can be applied for the following systems:

- Cruise control.
- Distance Control.
- Assisted Driving Mode.
- Assisted Driving Mode Plus.

The speed value is suggested as the new desired speed to be applied. To apply the speed value, the corresponding system must be activated.

Depending on the equipment, destination system and national-market version, the value can be applied automatically.

Safety information

Warning



The system cannot serve as a substitute for the driver's personal judgment in assessing the traffic situation. Based on the limits of the system, it cannot independently react to all traffic situations. There is a risk of accident, injury, and property damage. Adjust driving style to traffic conditions. Watch the surrounding traffic situation closely, be ready to take over steering and braking at any time, and actively intervene where appropriate.

Warning

The set speed can be incorrectly adjusted or called up by mistake. There is a risk of accident, injury, and property damage. Adjust the set speed to the traffic conditions. Watch surrounding traffic closely and actively intervene where appropriate.

Overview

Buttons on the steering wheel

Button	Function
	Accept suggested speed manually.
	Set speed, refer to page 223.

Turning Speed Limit Assistant on/off

1. To configure the settings for Speed Limit Assist, go through the menu as follows: Apps menu / "Vehicle" / "Driving settings" / "Driver Assistance" / "Driving" / "Speed Limit Assistant".
2. Select the desired setting:
 - "Adjust automatically": depending on the equipment, detected speed limits are applied automatically.
 - "Adjust manually": detected speed limits can be applied manually.
 - "Show current limit": Current speed limits are displayed on the Interaction Unit without being applied.
 - "Off": depending on the national-market version, Speed Limit Info and Speed Limit Assistant will be turned off.



If necessary, other anticipatory comfort functions will be turned off.

Additional information:

Speed Limit Info, refer to page 221.

Views on the Interaction Unit

A message is displayed on the Interaction Unit when the Speed Limit Assistant and a speed control system activate.

Icon	Function
	Detected change of a speed limit with immediate effect.
	Depending on the national-market version, it is possible to switch between the units of measurement.
	Indicator light illuminates green: The detected speed limit can be applied with the SET button. After it has been applied, a green checkmark is displayed.

Automatic adoption

"Adjust automatically": Distance Control automatically adopts any detected speed limits when driving on roads with barriers separating traffic in opposing directions.

It may not be possible to use this function when driving with a trailer.

 After automatic adoption, the SET button on the left side of the steering wheel can be pressed to switch back to the last value set for desired speed.

Manual adoption

A detected speed limit can be applied manually to the active speed control system.

 When the SET icon is displayed, press the SET button on the left side of the steering wheel.

Speed adjustment

General information

Speed Limit Assist can be configured to adopt the speed limit 1:1 or with a tolerance.



A speed adaptation for all speed limits and an additional speed adaptation for speed limits up to 40 mph/60 km/h can be set up. The additional speed adaptation for speed limits up to 40 mph/60 km/h can be activated or deactivated.

- System limits of Speed Limit Info, refer to page 222.
- System limits of the sensors, refer to page 40.
- Driving with trailer or rear carrier, refer to page 320.

Setting the speed adjustment

1. To adjust the speed for Speed Limit Assist, go through the menu as follows: Apps menu / "Vehicle" / "Driving settings" / "Driver Assistance" / "Driving" / "Speed Limit Assistant".
2. Select the desired setting:
 - "Adjust speed limits": Set a tolerance for a speed adjustment. This tolerance applies to all speed limits.
 - "2nd adjustment up to ": Activate or deactivate additional speed adjustment.
 - "Adjust speed limits": First activate additional speed adjustment, then set a tolerance for speed limits up to 40 mph/60 km/h.

System limits

Speed Limit Assistant is based on the Speed Limit Info system.

Note the system limits for Speed Limit Info.

Speed limits cannot be applied automatically when using Cruise Control without Distance Control.

If your vehicle is equipped with a trailer hitch, the speeds to be adopted are limited to the trailer towing speed set on the Interaction Unit.

Additional information:

Adapting the speed to the route

Principle

The cruise control can be configured to automatically adjust the vehicle speed to the route when Distance Control is active.

For instance, the speed will be reduced in the following situations as necessary:

- Before making turns.
- Before a roundabout.
- Before a curve.
- In front of an exit ramp on highways or highway-like roads.

This function is operated via the Interaction Unit.

Safety information

Warning

The system cannot serve as a substitute for the driver's personal judgment in assessing the traffic situation. Based on the limits of the system, it cannot independently react to all traffic situations. There is a risk of accident, injury, and property damage. Adjust driving style to traffic conditions. Watch the surrounding traffic situation closely, be ready to take over steering and braking at any time, and actively intervene where appropriate.



The Cruise Control, Distance Control, Assisted Driving Mode, and Speed Limit Assist alerts also apply.

Additional information:

- Cruise control, refer to page [225](#).
- Distance Control, refer to page [228](#).
- Assisted Driving Mode, refer to page [234](#).
- Speed Limit Assistant, refer to page [245](#).

Functional requirements

The following functional requirements apply when adapting vehicle speed to the route:

- Cruise Control and Distance Control are activated.
- Driving on a highway or highway-like road.
- Guidance is activated in the navigation system.

The use of navigation software via Apple CarPlay or Android Auto may lead to functional limitations, for instance deviations with navigation instructions.

- The function must be available in the country in which the vehicle is driven.
- If the vehicle is equipped with a trailer hitch, use the Interaction Unit to configure the settings and specify whether the vehicle is towing a trailer or rear carrier, respectively.

Additional information:

Driving with trailer or rear carrier, refer to page [320](#).

Adapting speed automatically to route

To activate/deactivate automatic speed adjustment, go through the menu as follows: Apps menu / "Vehicle" / "Driving settings" / "Driver Assistance" / "Driving" / "Route speed control" / "Adjust speed automatically".

Adjusting the cornering speed

The cornering speed can be adjusted depending on national-market version.

1. Go through the menu as follows: Apps menu / "Vehicle" / "Driving settings" / "Driver Assistance" / "Driving" / "Route speed control" / "Cornering speed".
2. Select the desired setting.

Views on the Interaction Unit

Depending on vehicle equipment and national-market version, in Assisted View, Route-Ahead Assistant information is shown in the central display area on the Interaction Unit.

Additional information:

Assisted View, refer to page [157](#).

System limits

Depending on national-market version or the country in which the vehicle is currently being driven, the Route-Ahead Assistant may not be available.

The system does not react or reacts to a limited extent to the route ahead in the following situations:

- If the vehicle location cannot be clearly determined by the navigation system.
- On wintry roads.

Additionally, the limits for Cruise Control, Distance Control, Assisted Driving, and Speed Limit Assist systems apply.

Additional information:

- Cruise control, refer to page [225](#).
- Distance Control, refer to page [228](#).
- Assisted Driving Mode, refer to page [234](#).
- Speed Limit Assistant, refer to page [245](#).

Parking

Vehicle features and options

This chapter describes model-specific equipment, systems, and functions that are currently available, or may become available in the future, even if they are not present in the vehicle.

Additional information:

Vehicle equipment, refer to page 8.

Parking assistance systems

Principle

With the Park Distance Control display and various camera views, the parking assistance systems help to park, maneuver, and reverse the vehicle. Parking assistance systems are operated using the Park Assist key or via the Parking menu.

When parking or reversing, the following individual systems provide active support with assistance functions and sensors:

- Park Distance Control, refer to page 262.
- Active Park Distance Control, refer to page 265.
- Drive-off monitoring, refer to page 267.
- Park Assist, refer to page 268.
- Maneuver Assistant, refer to page 274.
- Remote Control Parking, refer to page 277.
- Reversing Assistant, refer to page 279.
- Trailer Assistant, refer to page 322.

Various camera views and camera perspectives provide excellent visibility of the vehicle surroundings while parking and maneuvering. Depending on vehicle equipment, different camera views are available.

The following camera views can be used with the basic version:

- Rearview camera, refer to page 254.
- Trailer hitch view, refer to page 257.
- Panorama view, rear, refer to page 258.

Depending on vehicle equipment, additional camera views can be used with parking view:

- Semi-automatic camera perspective, refer to page 255.
- Automatic camera perspective, refer to page 255.
- Side view, refer to page 256.
- 3D view, refer to page 257.
- Car wash view, refer to page 258.
- Panorama view, front, refer to page 258.
- Activating panorama view using activation points, refer to page 259.
- Door opening angle, refer to page 260.
- Remote 3D View, refer to page 261.

The individual camera-based systems are operated by selecting camera views on the Interaction Unit. The camera views can be turned on and off by selecting the corresponding icon. Additional views with parking assistance lines or obstacle markings can be shown.

Safety information

Warning

The system cannot serve as a substitute for the driver's personal judgment in assessing the traffic situation. Based on the limits of the system, it cannot independently react to all traffic situations. There is a risk of accident, injury, and property damage. Adjust driving style to traffic con-



ditions. Watch the surrounding traffic situation closely, be ready to take over steering and braking at any time, and actively intervene where appropriate.

Overview

Button in the vehicle



The Park Assist key is located on the switch cluster.

Sensors

The parking assistance systems are controlled by the following sensors:

- Ultrasonic sensors in the front/rear bumpers.
- Ultrasonic sensors at the sides.
- Front camera.
- Exterior mirror cameras.
- Rearview camera.

Additional information:

Sensors of the vehicle, refer to page 40.

Calling up Park menu

Some parking assistance systems can be set individually in the Park menu.

1. To bring up the Parking menu, go through the menu as follows: Apps

menu / "Vehicle" / "Driving settings" / "Driver Assistance" / "Parking".

2. Select the desired settings.

Display

Turning display on/off

General information

The parking assistance systems view switches off automatically when driving forwards or if a certain distance or speed is exceeded.

With reverse gear

When drive-ready state is on, the parking assistance systems display is automatically turned on when you engage selector lever position R.

With the Park Assist key



To turn on the parking assistance system display, press the Park Assist key on the switch cluster.

On the Interaction Unit

To turn on the parking assistance systems display, go through the menu as follows: Apps menu / "Vehicle" / "Parking".

Interaction Unit view

General information

The parking assistance system view on the Interaction Unit varies depending on vehicle equipment and the active parking assistance system.



Assistance view

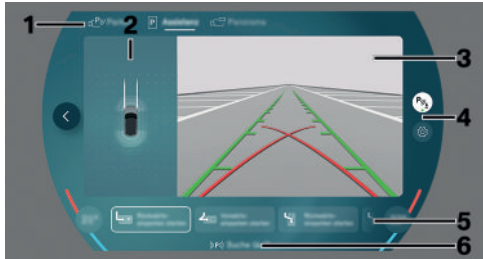

- 1 Selecting a camera view
- 2 Vehicle top view
- 3 Camera image
- 4 Settings
- 5 Toolbar, bottom
- 6 Status of parking assistance systems

Parking view

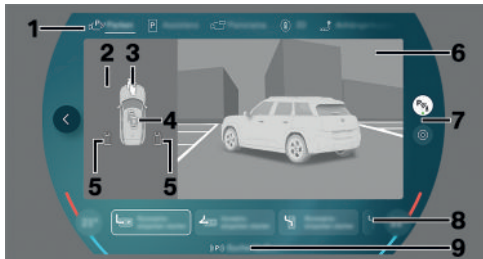

- 1 Selecting a camera view
- 2 Selection window
- 3 Automatic camera perspective
- 4 Semi-automatic camera perspective
- 5 Side view
- 6 Camera image
- 7 Settings
- 8 Toolbar, bottom
- 9 Status of parking assistance systems

Camera image

Depending on the equipment, one or more cameras capture the area from different selectable perspectives.

Depending on the view, the vehicle's surroundings or a part of it is depicted.

Depending on the national-market version, either the automatic or the semi-automatic camera perspective is displayed.

Selecting a camera view

Depending on vehicle equipment, various camera views can be selected at the top of the Interaction Unit:

- "Parking"
Depending on vehicle equipment, camera views or the Park Distance Control view are displayed.
- "Assistance"
A stylized top view of the vehicle is displayed.
- "Panorama"
The cross traffic view is displayed.
- "3D"
A three-dimensional view of the vehicle is displayed.
- "Trailer hitch"
The view shows the zoom onto the trailer hitch.
- "Car wash"
Your own lane can be displayed to make it easier to drive into a car wash.

Settings

Various settings are provided on the right side of the Interaction Unit:

- Depending on national-market version, the acoustic warning for Park Distance Control can be turned on/off.
- Settings can be configured in the Parking menu.

Toolbar, bottom

Parking Assistant functions are displayed on the bottom toolbar:





- Available parking methods of the Automatic Parking Assistant.
- Functions of the Back-up Assistant.
- Functions of the Maneuver Assistant.
- Trailer Assistant functions.
- Additional information in case of malfunctions.



Status of parking assistance systems

The status of the parking assistance systems is indicated by the icons at the bottom of the Interaction Unit, near the driving information, and on the Head-up display, depending on vehicle equipment. In addition to this icon, supplementary text appears at the bottom of the Interaction Unit.

The following parking assistance systems are displayed:

- Automatic Parking Assistant.
- Maneuver Assistant.
- Back-up Assistant.
- Trailer Assistant.

Icon	Meaning
	No search for parking assistance system offers.
	No other parking assistance systems available.
	Parking assistance systems have failed.
	Searching for parking assistance system offers is active.

Icon	Meaning
	White: an available maneuver is selected but is not being performed. Functional requirements have not been met or the function transfer is complete.
	Green: A parking assistance system is on. Functions are controlled depending on the system activated.
	The Maneuver Assistant records the maneuver to be saved.

Additional displays

General information

Additional views can be shown in the camera image for the parking assistance systems display, e.g., parking aid lines. This makes parking and maneuvering easier.

Several additional displays can be active at the same time.

Turning additional displays on/off

1. To turn additional displays in the camera view on/off, go through the menu as follows: Apps menu / "Vehicle" / "Driving settings" / "Driver Assistance" / "Parking".
2. Select the desired setting.

Parking aid lines

Pathway lines

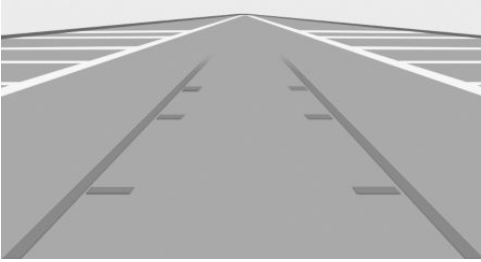

The pathway lines help to estimate the required space when parking and maneuvering on level roads.

Depending on engaged gear position, the Interaction Unit camera view provides pathway lines in front of or behind the vehicle.

The pathway lines are continuously adjusted to the steering movements depending on the steering-wheel angle.

Turning circle lines

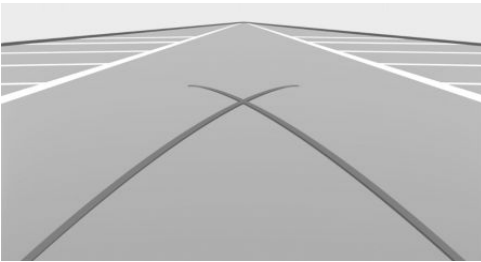

The Interaction Unit camera view includes turning circle lines that show the path with the smallest possible turning circle on a level road.

Only one turning circle line is displayed after the steering wheel is turned past a certain angle.

Turning circle lines can only be superimposed on the camera image together with pathway lines.

Using parking aid lines

1. Position the vehicle so that the red turning circle line leads into the boundaries of the parking space.
2. Turn the steering wheel so that the green pathway line covers the corresponding turning circle line.

Obstacle marking

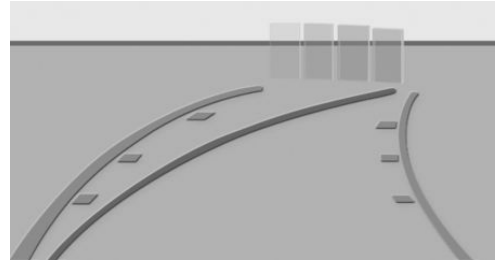

The sensors detect obstacles when parking. Obstacles detected by Park Distance Control are shown and marked in the camera view on the Interaction Unit.

Colored gradients for the obstacle markings in green, yellow and red indicate the distances.

Functional limitations

The parking assistance systems can only be used to a limited extent in the following situations:

- With a door open.
- With open cargo area.
- With exterior mirrors folded in.

Areas with gray hatching with an icon in the camera image identify areas that are currently not shown such as an open door.

System limits

Safety information

Warning

Because of system limitations, this system may either not respond, or respond too late, incorrectly, or without cause. There is a risk of accident, injury, and property damage. Actively intervene as warranted. Refer to the information in this Owner's Manual regarding the scope of the system's operation and limitations.

System limits of the sensors

Parking assistance systems may be restricted by the system limits of the sensors.

Additional information:

Sensors of the vehicle, refer to page 40.

Field of view

Because of the camera angle, the areas under the vehicle cannot be viewed by the cameras.

Detection of objects

The sensors may not detect very low obstacles as well as high, protruding objects, e.g., wall ledges.

Objects shown on the Interaction Unit may be closer than they appear. Do not estimate the distance to objects shown on the Interaction Unit.

The camera's detection range can be limited by protruding cargo, a rear carrier, or a trailer.

Malfunction

A camera failure is indicated on the Interaction Unit.

The malfunctioning camera's detection range is shaded.

Rearview camera

Principle

The rearview camera helps when reverse parking and maneuvering. The area behind the vehicle is shown in the camera view on the Interaction Unit. The rearview camera turns on when reversing and can be operated via the Interaction Unit or Park Assist key.

Additional displays can be shown on the camera view, e.g., parking assistance lines and obstacle markings.

General information

Follow the information in the "Parking assistance systems" chapter.

Functional requirements

The following functional requirements apply for the rearview camera:

- The cargo area is fully closed.
- The camera area is clean and clear.

Turning the rearview camera on/off



Turning the camera view on automatically

The rearview camera is automatically turned on if selector lever position R is engaged while drive-ready state is on.

Turning the camera view off automatically

The rearview camera turns off automatically when driving forward or when a certain distance or speed is exceeded.

Turning the camera view on/off manually

-  To manually turn on the rearview camera, press the Park Assist key on the switch cluster.
The parking assistance systems view is displayed.
- Engage selector lever position R.
The rearview camera view is switched on.
 Depending on vehicle equipment: The icon for automatic camera perspective is automatically selected in the selection window.

To exit rearview camera view, select another camera view in the selection window or press the Park Assist key again.

Deactivated rearview camera

When the rearview camera is deactivated, for instance when the cargo area is open, the camera image is displayed with gray shading.

Semi-automatic camera perspective

Principle



Depending on the parking direction and engaged selector lever position, the semi-automatic camera perspective shows a fixed camera perspective with the areas in front of or behind the vehicle.

The camera perspective can be turned on/off using the Interaction Unit.

General information

Follow the information in the "Parking assistance systems" chapter.

Turning the semi-automatic camera perspective on/off

-  To turn on semi-automatic camera perspective, press the Park Assist key on the switch cluster.
The parking assistance systems view is displayed.
-  Select the semi-automatic camera perspective icon in the selection window.
To exit the fixed camera view, select another camera view in the selection window.

Automatic camera perspective

Principle

The automatic camera perspective shows a steering-dependent view in the respective driving direction. This perspective adapts to the respective driving situation.

As soon as obstacles are detected, the view changes to a fixed display of the area in front of or behind the bumper, or switches to side Park Distance Control as necessary.

The side Park Distance Control is automatically displayed when the automatic camera perspective is turned on. The function shows obstacles located next to the vehicle.

The camera perspective can be turned on/off using the Interaction Unit.

General information

Follow the information in the "Parking assistance systems" chapter.

Turning the automatic camera perspective on/off

Turning the camera view on/off automatically

When the parking assistance systems' display is turned on, automatic camera perspective is selected automatically.

The icon for automatic camera perspective is automatically selected in the selection window.

To exit the steering-dependent camera view, select another camera view in the selection window.

When reverse gear is engaged, the automatic camera perspective is, if necessary, exited and the system uses a semi-automatic camera perspective to the rear. If necessary, select the automatic camera perspective when reverse gear is engaged. The automatic camera perspective will then be maintained for the current parking operation.

Turning the camera view on/off manually

1.  To turn on automatic camera perspective manually, press the Park Assist key on the switch cluster.

The parking assistance systems view is displayed.

2.  The icon for automatic camera perspective is automatically selected in the selection window.

To exit the steering-dependent camera view, select another camera view in the selection window or press the Park Assist key again.

Lateral Parking Aid display



To protect the sides of the vehicle, obstacle markings are displayed on the sides of the vehicle.

Colored obstacle markings warn the driver when obstacles have been detected.

If no obstacle markings are displayed, no obstacles have been detected.

Limits of the side protection

The Lateral Parking Aid only displays stationary obstacles that were previously detected by the sensors while passing them.

The system does not detect whether an obstacle moves later on. For this reason, at standstill, the marks are not shown anymore in the display after a certain time. The area next to the vehicle must be newly captured.

Side view

Principle

Side view shows the vehicle's side surroundings, making it easier to position the vehicle at the curb or with other obstacles on the side.

The camera view looks from the rear to the front and, if there is a hazard, focuses automatically on potential obstacles.



The side view can be turned on/off using the Interaction Unit.

General information

Follow the information in the "Parking assistance systems" chapter.

Turning the side view on/off

The selection window lets you choose the side view for the left or right side of the vehicle.

1.  To turn on side view, press the Park Assist key on the switch cluster.
The parking assistance systems view is displayed.
2.  Select the camera icon for the desired vehicle side in the selection window.

To exit the side view, select another camera view in the selection window.

3D view

Principle

With 3D view, a circle is displayed around the vehicle top view in the selection window.

Fixed perspectives can be selected directly on the circular path in the selection window, or by swiping the vehicle in the middle of the camera image.

The current perspective is marked with a camera icon on the circular path.

3D view can be turned on/off using the Interaction Unit.

General information

Follow the information in the "Parking assistance systems" chapter.

Turning the 3D view on/off

1.  To turn on 3D view, press the Park Assist key on the switch cluster.
The parking assistance systems view is displayed.
2. In the upper selection area, select the following camera view: "3D".
To exit 3D view, select another camera view from the selection at the top.

Trailer hitch view

Principle

To make it easier to attach a trailer, you can zoom in on the view of the trailer hitch.

Trailer hitch view can be turned on/off using the Interaction Unit.

General information

When zooming in, remember that the view may no longer show certain obstacles.

Follow the information in the "Parking assistance systems" chapter.

Turning the trailer hitch view on/off

1.  To turn on trailer hitch view, press the Park Assist key on the switch cluster.
The parking assistance systems view is displayed.
2. In the upper selection area, select the following camera view: "Trailer hitch".

To exit trailer hitch view, select another camera view from the selection at the top.

Display

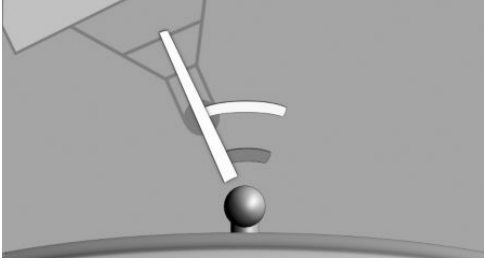

Two static circle segments are displayed in the camera image. These circle segments help to estimate the distance of the trailer to the trailer hitch.

A docking line dependent on the steering-wheel angle helps with aiming for the trailer with the trailer hitch.

Car wash view

Principle

The car wash view assists when entering a car wash.

This function can be turned on/off using the Interaction Unit.

General information

Follow the information in the "Parking assistance systems" chapter.

Turning the car wash view on/off

1.  To turn on car wash view, press the Park Assist key on the switch cluster.
The parking assistance systems view is displayed.
2. In the upper selection area, select the following camera view: "Car wash".

To exit car wash view, select another camera view from the selection at the top.

Display

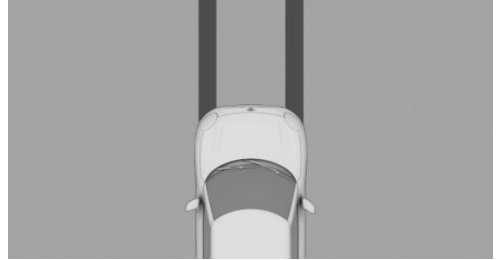

Your own lane is displayed for easier driving into a car wash.

This view can be used to position the vehicle correctly within the washing system guide rails.

In a car wash, the vehicle must be able to roll freely forward.

Additional information:

Rolling or pushing the vehicle, refer to page 130.

Panorama View

Principle

The panoramic view gives you an earlier view of crossing traffic at blind driveway exits and intersections.

Road users concealed by obstacles to the left and right of the vehicle can only be detected relatively late from the driver's seat. To provide greater visibility, the front camera and, depending on vehicle equipment, rearview camera cover the side of the vehicle.

Depending on vehicle equipment, this function can be used when reversing or driving forward.

Panorama view can be turned on/off using the Interaction Unit.

Depending on vehicle equipment, this function can be activated automatically by saving activation points.

General information

The camera image shows different levels of distortion in some areas and is thus not suitable for distance estimations.

Follow the information in the "Parking assistance systems" chapter.

Sensors

Panorama view is controlled by the following sensors:

- Rearview camera.
- Depending on if vehicle is equipped with front camera.

Turning the panoramic view on/off

1.  To turn on panorama view, press the Park Assist key on the switch cluster.

The parking assistance systems view is displayed.

2. In the upper selection area, select the following camera view: "Panorama".

To exit panorama view, select another camera view from the selection at the top.

Display

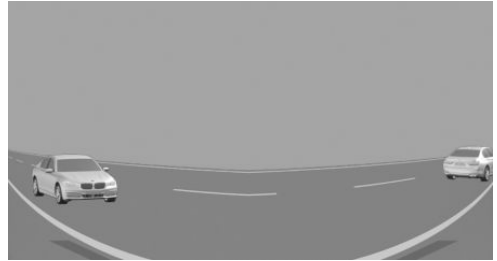

Yellow lines on the screen display identify the bumpers of your own vehicle.

When reverse gear is engaged, the reversing camera view is displayed. Depending on vehicle equipment, the front camera view is displayed when forward gear is engaged.

Automatic activation of panorama view

Principle

Positions at which panorama view should switch on automatically can be saved as activation points.

Up to ten activation points can be saved and edited.

The activation points can be used when driving forward and, depending on national-market version, when reversing.

General information

Follow instructions in the Parking assistance systems chapter.

Functional requirements

The following functional requirements apply for automatic activation of panorama view:



- A GPS signal must be received.
- Depending on national-market version: A MINI ID or driver profile must be activated.
- The reversing camera and front camera must be installed.
- The direction of travel, the selector lever position, and the vehicle angle must match a stored activation point.

Storing activation points

Desired activation points can be saved.

1. Drive your vehicle to the location where you want panorama view to switch on automatically, then stop.



2. Press the Park Assist key on the switch cluster.

The parking assistance systems view is displayed.

3. Go through the menu as follows: "Panorama" / "Activation point" / "Save activation point".

Activation points are saved with the following information, for example:

- With the city/town.
- With the city/town and the street.
- A default name.

You can rename the location and street information created automatically.

Using activation points

To enable/disable the use of activation points, go through the menu as follows: Apps menu / "Vehicle" / "Driving settings" / "Driver Assistance" / "Parking" / "GPS-based".

Editing activation points

Activation points can be renamed or deleted, individually or collectively.



1. Press the Park Assist key on the switch cluster.

The parking assistance systems view is displayed.

2. Go through the menu as follows: "Panorama" / "Manage points".

A list of all saved activation points is displayed.

- To edit an activation point, press and hold the desired activation point.
- To delete an activation point, swipe over the desired activation point.

Door opening angle

Principle

Depending on vehicle equipment, the door opening angle display is shown automatically when stationary.

This display helps estimate how far the doors can be opened when parking.

If obstacle marking is activated, the parking view indicates fixed obstacles that obstruct the opening angles of the doors.

General information

Follow the information in the "Parking assistance systems" chapter.

Display



The maximum opening angle of the doors is displayed in selector lever position P.

System limits

The door opening angle view does not warn you of approaching road users.

The vehicle's surroundings are distorted in the display for technical reasons.

Even if no objects are visible in the door opening angle view on the Interaction Unit, park carefully when near other objects.

Because of the perspective, higher, protruding objects may be closer than they appear on the Interaction Unit.

Remote 3D View

Principle

The MINI app and parking camera views, e.g., automatic camera perspective, can be used to display the vehicle's surroundings on a mobile device.

Remote 3D View shows a snapshot of the situation.

General information

For reasons of data protection, Remote 3D View can only be used three times within two hours.

Follow the information in the "Parking assistance systems" chapter.

Sensors

Remote 3D View is controlled by the following sensors:

- Front camera.
- Exterior mirror cameras.
- Rearview camera.

Functional requirements

The following functional requirements apply for Remote 3D View:

- Data transfer must be activated.
- The MINI app must be installed on the mobile end device.
- In MINI Connected countries, an existing MINI Connected account must be used to activate a MINI ID.

Additional information:

- Data protection, refer to page 66.
- MINI ID, refer to page 67.

Activating/deactivating Remote 3D View

Remote 3D View can be activated or deactivated individually or together with other functions.

1. Go through the menu as follows: Apps menu / "All" / "Data privacy".
2. Select the desired setting.
After activating, Remote 3D View can be accessed in the MINI app.

System limits

Remote 3D View may not be fully operational or may not be available in the following situations:



- With a door or the cargo area open. Dark fields in the display indicate areas that are not recorded by the system.
- With manually folded-in exterior mirrors.
- When other camera functions are being performed in the vehicle.
- The vehicle moves faster than walking speed.
- In case of missing or weak Internet connection.

Park Distance Control

Principle

Park Distance Control assists with parking. Acoustic and visual warnings signal obstacles in front of or behind the vehicle.

Obstacles that are detected by the side ultrasonic sensors can also be reported.

The range of Park Distance Control, depending on obstacles and environmental conditions, is approx. 6 ft/2 m.

Park Distance Control turns on and off automatically in certain situations: The Interaction Unit is used to enable/disable automatic activation.

General information

Follow the information in the "Parking assistance systems" chapter.

Safety information

Warning

The system cannot serve as a substitute for the driver's personal judgment in assessing the traffic situation. Based on the limits of the system, it cannot independently react to all traffic situations. There is a risk of accident, injury, and property

damage. Adjust driving style to traffic conditions. Watch the surrounding traffic situation closely, be ready to take over steering and braking at any time, and actively intervene where appropriate.

Warning

Due to high speeds when the Park Distance Control is activated, the warning can be delayed due to physical circumstances. There is a risk of injury and risk of property damage. Avoid approaching an object too fast. Avoid driving off quickly while Park Distance Control is not yet active.

Sensors

Park Distance Control is controlled by the following sensors:

- Ultrasonic sensors in the front/rear bumpers.
- Ultrasonic sensors at the sides.

Turning Park Distance Control on/off

Turning on the system automatically

Park Distance Control switches on automatically in the following situations:

- When drive-ready state is switched on when selector lever position R is engaged.
- While approaching detected obstacles if the speed is lower than approx. 2.5 mph/4 km/h. The activation distance depends on the situation in question.

To activate/deactivate automatic activation when obstacles are detected, go through the menu as follows: Apps menu / "Vehicle" / "Driving settings" / "Driver Assistance" / "Parking" / "Automatic PDC activation".

Turning off the system automatically

Park Distance Control switches off automatically when driving forward or if a certain distance or speed is exceeded.

Turning the system on/off manually



To manually turn on Park Distance Control, press the Park Assist key on the switch cluster.

The parking assistance systems view is displayed.

When the LED above the Park Assist key illuminates, the system is on. When the LED goes out, the system is off.

If the system is manually switched on when the reverse gear is engaged, the rearview camera image is displayed.

Depending on the national-market version, the system cannot be turned off manually when the reverse gear is engaged.

Acoustic warning

General information

An intermittent tone is given as acoustic warning for Park Distance Control to signal an approaching object. E.g., when an object is detected at the rear left of the vehicle, a sound is heard from the rear left speaker.

The shorter the distance to the object, the shorter the intervals of the intermittent tones.

An acoustic warning sounds in case of an impending collision at a distance to the object of approx. 27 in/70 cm.

For objects behind the vehicle, the acoustic warning is issued as early as a distance to the object of approx. 5 ft/1.50 m.

When the distance to a detected object is less than approx. 8 in/20 cm, a continuous tone is sounded.

When there are objects in front of and behind the vehicle at the same time, at a distance smaller than approx. 8 in/20 cm, an alternating continuous tone will sound between the front and rear speakers.

The intermittent tones and the continuous tone are turned off when selector lever position P is engaged.

Depending on national-market version, the intermittent tones are switched off after a short time when the vehicle is stationary.

If an object approaches when the vehicle is stationary, the acoustic signal is reactivated.

Adjusting the volume

1. To adjust the volume of the acoustic warning, go through the menu as follows: Apps menu / "Vehicle" / "Driving settings" / "Driver Assistance" / "Parking" / "PDC signal volume".
2. Set the desired value.

Depending on national-market version: Turn off acoustic warning

Depending on national-market version, the acoustic warning can be turned off while performing a parking maneuver.

 Tap the acoustic warning icon on the right edge of the Interaction Unit. The icon turns gray and the LED below the icon goes out.

When the Park Distance Control is switched on again, the acoustic warning is automatically switched on again.

Visual warning

General information

If Park Distance Control is activated, the Interaction Unit will indicate when the vehicle is approaching an object.

Objects that are farther away are already displayed before a signal sounds.

Depending on the view, pathway lines, turning circle lines and obstacle markings are shown for a better estimation of the space required.

Depending on vehicle equipment, the sensor detection range is shown by the shaded, ring-shaped area. Green, yellow, and red markings indicate when obstacles are detected within the detection range.

If your vehicle is equipped with the Cross Traffic Warning, a warning is also shown on the display for vehicles approaching from the side at the rear and front.

To protect the sides of the vehicle, obstacle markings are displayed on the sides of the vehicle.

Display

Depending on vehicle equipment, warnings may be displayed in front of, next to, and behind the vehicle.

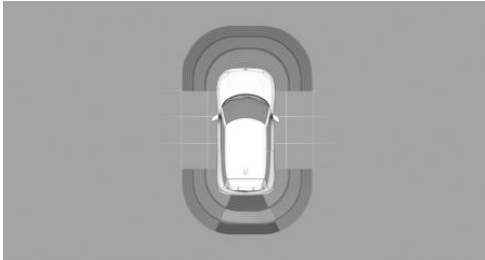

Example display of warnings behind the vehicle.

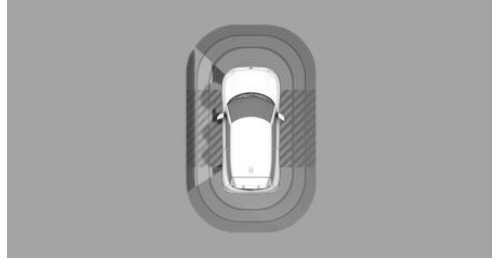

Example display of warnings next to the vehicle.

The gray shaded areas indicate the sensor detection range. No obstacles have been detected within detection range.

Colored markings in the shaded area indicate that obstacles have been detected within the detection range.

If the shaded area is not continuous, the area next to the vehicle has not been scanned yet.

System limits

General information

The function for protecting the vehicle sides only shows stationary obstacles that were previously detected by the sensors when passing by.

Park Distance Control does not detect when an obstacle moves later. When the vehicle is stationary, the gray shaded areas on the sides are hidden after a certain time. The area on the side of the vehicle must be newly captured.

Also follow the information on system limits in the "Parking assistance systems" chapter.

Trailer towing

The rear functions of Park Distance Control are turned off when towing a trailer or when the trailer socket is occupied.

Depending on vehicle equipment, the sensor detection range is shown by the shaded area on the Interaction Unit.

Obstacles next to the vehicle are not displayed.

Depending on the national-market version, the rear functions of Park Distance Control remain switched on when trailer towing is enabled.



The trailer towing icon is shown on the Interaction Unit.

Additional information:

Driving with trailer or rear carrier, refer to page [320](#).

Unwarranted warnings

Unwarranted warnings may be given if the system limits of Park Distance Control are reached.

To prevent unwarranted warnings, for instance in car washes, turn off automatic Park Distance Control activation on obstacle detection.

Malfuction



If Park Distance Control malfunctions, the Attention icon appears on the Interaction Unit.

Depending on vehicle equipment, the sensor detection range may not be shown.

A Check Control message is displayed.

Park Distance Control has failed. Have the vehicle checked by an authorized service center or another qualified service center or repair shop.

Active Park Distance Control

Principle

Active Park Distance Control is the brake function of Park Distance Control and initiates emergency braking in the event of an acute risk of collision.

The system can be used below walking speed when reversing or coasting backward.

Due to system limits, a collision cannot be prevented under all circumstances.

Pressing the accelerator pedal interrupts the brake intervention. Emergency braking is not performed.

The Interaction Unit can be used to temporarily deactivate Active Park Distance Control as well as configure the settings for this system.

General information

Follow the information in the "Parking assistance systems" chapter.

Safety information

Warning

The system cannot serve as a substitute for the driver's personal judgment in assessing the traffic situation. Based on the limits of the system, it cannot independently react to all traffic situations. There is a risk of accident, injury, and property damage. Adjust driving style to traffic conditions. Watch the surrounding traffic situation closely, be ready to take over steering and braking at any time, and actively intervene where appropriate.



Warning

When using the trailer hitch, the assistance system cannot react correctly because the sensors are concealed. There is a risk of accident, injury, and property damage. Do not use the driver assistance system while towing a trailer or when using the trailer hitch, e.g., for a rear bicycle rack.

Sensors

Active Park Distance Control is controlled by the following sensors:

- Ultrasonic sensors in rear bumpers.
- Ultrasonic sensors at the sides.
- Rearview camera.

Driving off after emergency braking

After emergency braking to a stop, further creeping toward an obstacle is possible. Proceed with caution. To move forward, lightly press the accelerator pedal and release as needed.

If the accelerator pedal is depressed longer, the vehicle drives off. Manual braking is possible at any time.

Deactivating Active Park Distance Control temporarily

After emergency braking, Active Park Distance Control can be temporarily deactivated on the Interaction Unit. A corresponding message is displayed.

Go through the menu as follows: "Configure" / "Deactivate temporarily".

No further emergency braking will be performed in this situation as you continue driving.

The function is automatically reactivated when Park Distance Control is switched on again.

Settings

You can configure which areas of your vehicle to protect with the Park Distance Control system.

1. Go through the menu as follows: Apps menu / "Vehicle" / "Driving settings" / "Driver Assistance" / "Parking" / "Active PDC emergency braking".
2. Select the desired setting.

Display



As soon as the system engages, an icon is displayed with a corresponding message.

System limits

General information

Follow the system limits in the "Parking assistance systems" chapter.

Functional limitation

Active Park Distance Control cannot be used in the following situations, for example:

- While Hill Descent Control is regulating the vehicle speed, emergency braking is deactivated.
- When driving with a trailer.

If applicable, turn off the system temporarily, if needed.

Additional information:

Hill Descent Control, refer to page [219](#).

Drive-off monitoring

Principle

In case of a risk of collision, the start-up monitoring reduces the drive power when driving off.

When obstacles are detected in close range in front of the vehicle, the acceleration will be reduced. If necessary, this permits timely manual braking.

When obstacles are detected behind the vehicle, the system will brake.

Drive-Off Monitoring can be activated/deactivated on the Interaction Unit.

You can cancel reduced acceleration, e.g., by pressing the accelerator twice.

General information

Follow the information in the "Parking assistance systems" chapter.

Safety information

Warning

The system cannot serve as a substitute for the driver's personal judgment in assessing the traffic situation. Based on the limits of the system, it cannot independently react to all traffic situations. There is a risk of accident, injury, and property damage. Adjust driving style to traffic conditions. Watch the surrounding traffic situation closely, be ready to take over steering and braking at any time, and actively intervene where appropriate.

Warning

When using the trailer hitch, the assistance system cannot react correctly because the sensors are concealed. There is a risk of accident, injury, and property

damage. Do not use the driver assistance system while towing a trailer or when using the trailer hitch, e.g., for a rear bicycle rack.

Sensors

Drive-off monitoring is controlled by the following sensors:

- Ultrasonic sensors in the front/rear bumpers.
- Ultrasonic sensors at the sides.

Functional requirements

The following functional requirements apply for drive-off monitoring:

- Selector lever position D, B, or R is engaged when the vehicle is stationary.
- Obstacles in the immediate vicinity are detected in front of or behind the vehicle.
- The accelerator pedal is heavily applied, nearly to the end point.
- The accelerator pedal is immediately applied after engaging the selector lever position and obstacle detection.

Activating/deactivating Drive-Off Monitoring

To activate/deactivate Drive-Off Monitoring, go through the menu as follows: Apps menu / "Vehicle" / "Driving settings" / "Driver Assistance" / "Parking" / "Drive off monitoring".

A Check Control message is displayed where applicable.

Depending on national-market version, this system turns on automatically for the next drive.



Canceling reduced drive power

The reduction of the drive power is canceled in the following situations:

- The accelerator pedal is released.
- After the accelerator pedal has been depressed completely twice.
- A specific distance has been traveled.

If the reduction in drive power is canceled by covering a certain distance, the drive power is released gradually.

Display



As soon as the system engages, an icon is displayed with a corresponding message.

System limits

General information

Follow the system limits in the "Parking assistance systems" chapter.

Functional limitation

Drive-off monitoring is deactivated when the trailer power socket is occupied or trailer towing is activated, e.g., when using a trailer or rear bicycle rack.

Automatic Parking Assistant

Principle

Automatic Parking Assistant provides support when parallel parking and parking transverse to the road.

In addition, the system makes it easier to park out of parallel and perpendicular parking spaces.

The ultrasonic sensors measure both sides of the vehicle when driving slowly forward. Suitable parking spaces are calculated based

on the objects detected, e.g., parking vehicles. The system status is displayed.

The system calculates the best possible parking line for driving in or out of parking spaces, and takes control of the vehicle while parking.

The operating principle and operation of Park Assist is divided into the following steps:

- Parking space search.
- Turning on.
- Parking.
- Driving out of parking spaces.

The parking manoeuvre while parking is performed automatically.

When driving out of parallel parking spaces, the vehicle maneuvers automatically until it reaches a position where it can be driven out of the parking space without further steering movements.

When driving out of perpendicular parking spaces, the vehicle is maneuvered out of the parking space to enable continued driving in the desired direction.

A parking maneuver can be interrupted and continued manually.

Settings can be customized as desired, e.g., to adjust how parking maneuvers are displayed or to set a sound for suitable parking spaces.

The Automatic Parking Assistant Professional increases the comfort and range of uses of the Automatic Parking Assistant. In addition to the parking methods of the Automatic Parking Assistant, parking in parking spaces that are marked with lines is possible. The parking maneuver can also be performed using Remote Control Parking on a smartphone.

Vehicle features and options

This system may not be available in the owned vehicle, e.g. due to the selected optional equipment, the national-market version or the option for later enabling and software updates. This also applies to individual functions of the system.

For information on whether a function is currently available in the vehicle or when the function can be installed in the vehicle, contact an authorized service center or another qualified service center or repair shop.

Additional information:

Vehicle equipment, refer to page 8.

General information

Follow the information in the "Parking assistance systems" chapter.

Safety information

Warning

The system cannot serve as a substitute for the driver's personal judgment in assessing the traffic situation. Based on the limits of the system, it cannot independently react to all traffic situations. There is a risk of accident, injury, and property damage. Adjust driving style to traffic conditions. Watch the surrounding traffic situation closely, be ready to take over steering and braking at any time, and actively intervene where appropriate.

Warning

When using the trailer hitch, the assistance system cannot react correctly because the sensors are concealed. There is a risk of accident, injury, and property damage. Do not use the driver assistance system while towing a trailer or when us-

ing the trailer hitch, e.g., for a rear bicycle rack.

Warning

The system can steer the vehicle over or onto curbs. There is a risk of injury and risk of property damage. Watch surrounding traffic closely and actively intervene where appropriate

Parking methods

Park Assist supports the following functions:

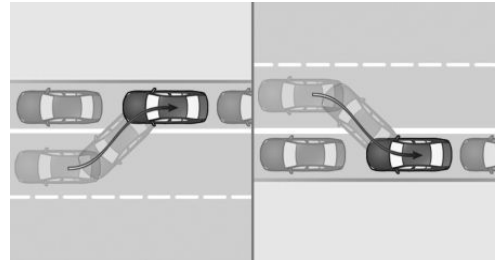

When parallel parking: Parking in reverse, parallel to the road.

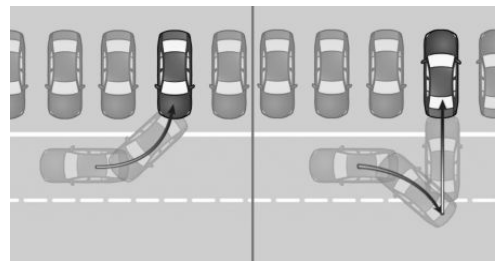

When perpendicular parking: Parking forward or in reverse, perpendicular to the road.

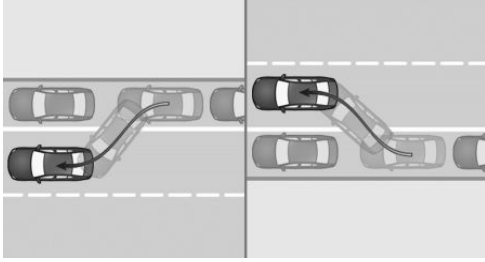

When driving out of parallel parking spaces.

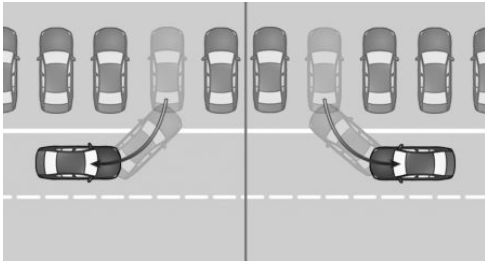

When driving out of perpendicular parking spaces.

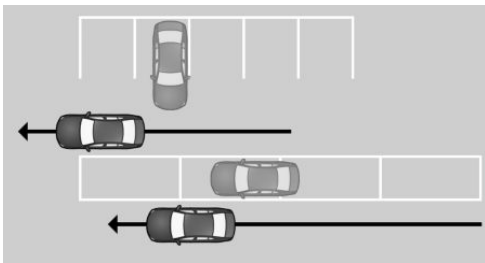

With Park Assist Professional: Parking in car parks with parking lines.

Sensors

The Automatic Parking Assistant is controlled by the following sensors:

- Ultrasonic sensors in the front/rear bumpers.
- Ultrasonic sensors at the sides.

The Automatic Parking Assistant Professional is additionally controlled by the following cameras:

- Front camera.
- Exterior mirror cameras.
- Rearview camera.

Functional requirements

Measurement of parking spaces

The following functional requirements apply when measuring parking spaces:

- Driving forward: up to approx. 22 mph/35 km/h.
- Maximum distance to row of parked vehicles: approx. 5 ft/1.5 m.

Suitable parking space

The following functional requirements apply for suitable parking spaces:

Longitudinal parking:

- Minimum length of detected object, e.g., parking vehicle: approx. 3 ft/1 m.
- Minimum length of gap between two objects: vehicle length plus approx. 2.6 ft/0.8 m.
- Minimum depth: approx. 5 ft/1.5 m.

Perpendicular parking:

- Minimum length of detected object, e.g., parking vehicle: approx. 3 ft/1 m.
- Minimum width of gap: vehicle width plus approx. 2.3 ft/0.7 m.
- The minimum depth corresponds to your vehicle's length.

The depth of perpendicular parking spaces must be estimated by the driver. Due to technical limitations, the system is only able to approximate the depth of perpendicular parking spaces.

Parking lines for Park Assist Professional:

- The parking space must be clearly marked with lines.
- The one-time calibration of the camera after vehicle delivery must be complete. Drive a few kilometers in daylight to do so.

Parking operation

The following functional requirements apply when pulling into a parking space:

- The doors and cargo area are closed.
- The driver's seat belt is fastened.

Leaving parking spaces

The following functional requirements apply when pulling out of a parking space:

- The vehicle was parked using the Automatic Parking Assistant, and an object has been detected in the area around the vehicle.
- The vehicle was manually parked in reverse, and objects have been detected in the immediate vicinity of the vehicle. The distance to a detected curb is at least 6 inches/15 cm.
- The parking space is at least 2.6 ft/0.8 m longer than the vehicle.

Displays





General information

The current status of the Automatic Parking Assistant is shown on the Interaction Unit and Head-up display, depending on vehicle equipment.

Various icons are shown when selecting the parking method.

The sequence of the displayed icons corresponds to the prioritized parking option.

The direction of the arrow changes for the icons for parking methods for driving out of a parking space.

Icon	Meaning
	Reverse lengthwise parking, right.
	Reverse lengthwise parking, left.
	Reverse perpendicular parking.
	Forward perpendicular parking.

Turning parking operation display on/off

When the Automatic Parking Assistant is enabled, the parking maneuver is displayed in the camera view on the Interaction Unit.

To turn the parking maneuver display on/off, go through the menu as follows: Apps menu / "Vehicle" / "Driving settings" / "Driver Assistance" / "Parking" / "Show assistance information".

Turning the signal tone on/off

To turn the signal tone for suitable parking spaces on/off, go through the menu as follows: Apps menu / "Vehicle" / "Driving settings" / "Driver Assistance" / "Parking" / "Sound when available".

Parking using the Automatic Parking Assistant

When parking with Park Assist, you must select a parking method depending on the available parking spaces.

1. For the parking space search when driving past parked vehicles at a speed of up to approx. 22 mph/35 km/h and a distance of max. 5 ft/1.5 m.

 The parking space search is activated.

2.  Press the Park Assist key on the switch cluster or engage reverse gear.



The parking assistance systems view is displayed.

The parking space search and possible parking spaces are shown on the Interaction Unit.

3. Select one of the parking methods offered on the Interaction Unit. You can switch to another parking maneuver as necessary.

 The status symbol for the Automatic Parking Assistant illuminates green. The system takes control of the parking operation.

4. Follow the instructions on the Interaction Unit.

The speed can be reduced with the brake. Other interventions will cancel the system.

Depending on national-market version, an intermittent or continuous tone sounds for Park Distance Control.

At the end of the parking operation, selector lever position P is set.

The end of the parking maneuver is indicated on the Interaction Unit.

5. Adjust the parking position yourself, if needed.

Driving out of a parking space using the Automatic Parking Assistant

1. Switch on drive-ready state to pull out of the parking space using Park Assist.



2.  When your vehicle is stopped, press the Park Assist key on the switch cluster or engage reverse gear.

The parking assistance systems view is displayed.

3. On the Interaction Unit, select the desired parking method.

4. Follow the instructions on the Interaction Unit.

 The status symbol for the Automatic Parking Assistant illuminates green. The system takes control of the maneuver.

The speed can be reduced with the brake. Other interventions will cancel the system.

A message will be displayed at the end of the maneuver.

5. Make sure that the traffic situation permits driving out of parking space and driving off as usual.

The Automatic Parking Assistant is turned off automatically.

Canceling Automatic Parking Assistant manually

The Automatic Parking Assistant can be canceled manually at any time, e.g.:

- Step lightly on the accelerator pedal twice in succession.
- Step lightly on the accelerator pedal and move the steering wheel slightly at the same time.
- Depress the brake pedal and operate the selector lever at the same time.

The Automatic Parking Assistant is canceled without engaging selector lever position P. Driving can continue immediately.

Canceling Automatic Parking Assistant automatically

Park Assist is canceled automatically in situations such as the following:

- When the driver grasps the steering wheel or takes over steering.
- When operating the accelerator pedal or the selector lever.
- When setting the parking brake.
- When unfastening the driver's seat belt.

- With open cargo area.
- With open hood.
- With the doors open.
- During activation or intervention by driver assistance systems.
- When switching to other functions on the Interaction Unit.
- When overlaying messages on the Interaction Unit display.
- On snow-covered or slippery road.
- On steep uphill or downhill grades.
- When there are obstacles that are hard to overcome such as curbs.
- When there are obstacles that suddenly appear.
- With insufficient distances, which are indicated by Park Distance Control.
- When a maximum number of parking attempts or the time taken for parking is exceeded.

When the system is automatically aborted, selector lever position P is engaged.

A Check Control message is displayed where applicable.

Continuing the parking operation

If parking or leaving a parking space has been interrupted, the operation can be continued, if needed.

Restart the Automatic Parking Assistant and follow the instructions on the Interaction Unit.

System limits

General information

Follow the system limits in the "Parking assistance systems" chapter.

No parking assistance

The Automatic Parking Assistant does not offer assistance in the following situations:

- In tight curves.
- For diagonal parking spaces.
- When towing a trailer.
- Automatic Parking Assistant: for parking spaces that are only marked with lines on the ground. The system orients itself according to objects.
- For special parking spaces, e.g., metered parking spaces with automatic locking mechanisms, or mechanical parking systems.

Functional limitations

Park Assist may be restricted in the following situations:

- On bumpy road surfaces such as gravel roads.
- On slippery ground.
- On steep uphill or downhill grades.
- With accumulations of leaves/snow in the parking space.
- In case of changes to an already-measured parking space.
- With ditches or edges, for instance an edge of a port.
- Parking spaces that are not suitable may be detected or suitable parking spaces may not be detected at all.

Malfunction

A Check Control message is displayed.

The Automatic Parking Assistant may not be operational. Have the vehicle checked by an authorized service center or another qualified service center or repair shop.



Maneuver Assistant

Principle

The Maneuver Assistant provides support for recurring parking and maneuvering situations.

Parking and maneuvering operations can be recorded and then carried out automatically by the system.

A recurring maneuver is driven manually and thereby recorded.

When the vehicle reaches the activation area for the distance covered by the saved maneuver, the maneuver can be activated on the Interaction Unit.

After the activation, the system takes control of the vehicle and carries out the maneuver automatically.

In addition, the parking maneuver can be performed using Remote Control Parking on a smartphone.

Vehicle features and options

This system may not be available in the owned vehicle, e.g. due to the selected optional equipment, the national-market version or the option for later enabling and software updates. This also applies to individual functions of the system.

For information on whether a function is currently available in the vehicle or when the function can be installed in the vehicle, contact an authorized service center or another qualified service center or repair shop.

Additional information:

Vehicle equipment, refer to page 8.

General information

Follow the information in the "Parking assistance systems" chapter.

Safety information

Warning

The system cannot serve as a substitute for the driver's personal judgment in assessing the traffic situation. Based on the limits of the system, it cannot independently react to all traffic situations. There is a risk of accident, injury, and property damage. Adjust driving style to traffic conditions. Watch the surrounding traffic situation closely, be ready to take over steering and braking at any time, and actively intervene where appropriate.

Warning

When using the trailer hitch, the assistance system cannot react correctly because the sensors are concealed. There is a risk of accident, injury, and property damage. Do not use the driver assistance system while towing a trailer or when using the trailer hitch, e.g., for a rear bicycle rack.



Warning

The system can steer the vehicle over or onto curbs. There is a risk of injury and risk of property damage. Watch surrounding traffic closely and actively intervene where appropriate.

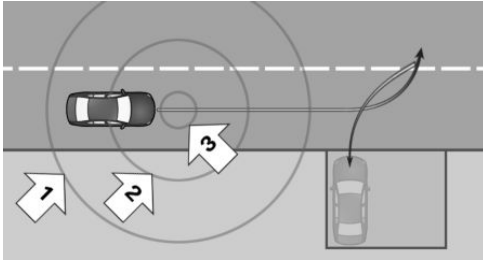
Detection range



The detection range for a maneuver is divided into the following areas:

- Proximity range, arrow 1: the system will begin with the localization in the background within a range of approx. 26 ft/8 m around the distance covered of a stored maneuver.
-  Close range, arrow 2: A saved maneuver can be displayed on the Interaction Unit within a range of approx. 6 ft/2 m around the distance covered.
-  Activation range, arrow 3: The saved maneuver can be activated on the Interaction Unit within a range of approx. 3.5 ft/1 m. After the activation, the system takes control of the vehicle and carries out the maneuver automatically.

Sensors

The Maneuver Assistant is controlled by the following sensors:

- Ultrasonic sensors in the front/rear bumpers.
- Ultrasonic sensors at the sides.
- Front camera.
- Exterior mirror cameras.
- Rearview camera.

Functional requirement

To use the Maneuver Assistant, the one-off calibration process of the camera after vehi-

cle delivery must be complete. Drive a few kilometers in daylight to do so.

Recording maneuver

General information

Up to ten maneuvers can be recorded at different locations.

Up to four overlapping maneuvers can be recorded.

Identical maneuvers under different ambient conditions can be recorded such as light conditions.

For each maneuver, a maximum distance covered of 656 ft/200 m is possible.

In total, a distance covered of approx. 1,969 ft/600 m distributed to the ten possible maneuvers can be recorded.

Maneuvers with a distance covered of less than 20 ft/6 m cannot be recorded.

Recording maneuver

1. To record a maneuver, drive the vehicle to the desired starting point and stop.



2. Press the Park Assist key on the switch cluster.

The parking assistance systems view is displayed.

3. On the bottom toolbar, select the following function:  "Record new path".
4. Drive the vehicle to the desired end position.

 "Recording active": The maneuver is recorded.

When recording a route, do not drive faster than 9 mph/15 km/h.

While recording, the distance covered will be displayed.

When the maximum distance covered or the maximum speed is reached, a mes-



sage will be displayed and a signal tone will sound.

5. While the vehicle is stationary, on the bottom toolbar, select the following function: "Save recording".

The maneuver can be saved with an automatically generated name, or renamed or discarded.

6. Select the desired action.

Performing stored maneuver

1. To perform the stored maneuver, drive the vehicle into the activation area and stop. The Interaction Unit indicates when a saved maneuver can be used.
2. Press the icon to select the stored maneuver.

The status symbol for the Maneuver Assistant illuminates green. After the activation, the system takes control of the vehicle and carries out the maneuver automatically. Follow the instructions on the Interaction Unit as necessary.

The speed can be reduced with the brake. Other interventions will cancel the system.

At the end of the parking operation, selector lever position P is set.

Canceling the Maneuver Assistant manually

The vehicle can be controlled manually during an active maneuver by taking the following actions:

- Step lightly on the accelerator pedal twice in succession.
- Step lightly on the accelerator pedal and move the steering wheel slightly at the same time.
- Depress the brake pedal and operate the selector lever at the same time.

The Maneuver Assistant is canceled without engaging selector lever position P. Driving can continue immediately.

Canceling the Maneuver Assistant automatically

The Maneuver Assistant is canceled automatically in situations such as the following:

- When the driver grasps the steering wheel or takes over steering.
- When operating the accelerator pedal or the selector lever.
- When the driver's seat belt is not fastened.
- With open cargo area.
- With open hood.
- With the doors open.
- During activation or intervention by driver assistance systems.
- When the system limits of the ultrasonic sensors and cameras are reached.
- When switching to other functions on the Interaction Unit.
- When overlaying messages on the Interaction Unit display.
- In case of obstacles.
- On snow-covered or slippery road.
- When the lane is too narrow.
- On steep uphill or downhill grades.
- With trailer towing.

In the event of an automatic cancellation of the system, the vehicle is decelerated to a complete stop and selector lever position P is engaged.

An interrupted maneuver can be continued, if needed. Restart the Maneuver Assistant and follow the instructions on the Interaction Unit.

Editing stored maneuvers

The Interaction Unit can be used to edit maneuvers, individually or collectively.

1. Go through the menu as follows: Apps menu / "Vehicle" / "Driving settings" / "Driver Assistance" / "Parking" / "Recorded paths".
2. Select the maneuver to be edited.
3. Select the desired action.

System limits

General information

Follow the system limits in the "Parking assistance systems" chapter.

Functional limitations

The Maneuver Assistant does not provide support when towing a trailer.

System limits can cause functional limitations such as in the following situations:

- With poor GPS reception.
- On steep uphill or downhill grades.
- In case of recorded maneuvers where the system minimum distance to objects cannot be maintained.
- Greatly deviating conditions when storing and driving the distance covered, for instance other tires or changed ambient conditions like light conditions or weather.
- Delayed display of overlapping stored maneuvers when driving into the activation area.
- In multi-story parking garages, for recordings at different parking levels, or for recordings that run over several parking levels.



If the calibration process for the camera is not completed after vehicle delivery, an icon appears on the

display of the parking assistance systems when reverse gear is engaged.

Tap the icon and follow the instructions on the Interaction Unit.

Remote Control Parking

Principle

With Remote Control Parking, the vehicle can be driven remotely when parking and maneuvering using the Maneuver Assistant and Park Assist Professional.

The maneuver is performed independently, without you having to be inside the vehicle, using a smartphone and the MINI app. This makes it easy to get in and out of the vehicle.

When parking in a suitable spot, e.g., a garage, the vehicle's parking position can be corrected by maneuvering manually with the MINI app.

A maneuver that has already been started can be continued at any time with Remote Control Parking.

Vehicle features and options

This system may not be available in the owned vehicle, e.g. due to the selected optional equipment, the national-market version or the option for later enabling and software updates. This also applies to individual functions of the system.

For information on whether a function is currently available in the vehicle or when the function can be installed in the vehicle, contact an authorized service center or another qualified service center or repair shop.

Additional information:

Vehicle equipment, refer to page 8.



General information

Note the information in the Automatic Parking Assistant and Maneuver Assistant chapter.

Protect the smartphone against unauthorized use.

The low-beam headlights are switched on for the duration of the maneuver.

A parking maneuver offered by Park Assist Professional is only available for Remote Control Parking for a short time after exiting the vehicle.

Functional requirements

The following functional requirements apply for Remote Control Parking:

- All occupants have left the vehicle.
- The doors and cargo area are closed.
- Make sure that no one is located within range of the maneuver.
- Make sure that no one is located in the narrow spaces between the vehicle and stationary objects, e.g., between the vehicle and a garage wall.
- To manually correct the vehicle position on the MINI app, the minimum width of the parking space must be the vehicle width plus 1.9 ft/0.6 m.
- The smartphone is compatible with Remote Control Parking.
- The MINI app must be installed on a compatible smartphone.
- The MINI app must be linked to a MINI Connected account.
- Bluetooth must be enabled on the smartphone.
- The distance between vehicle and smartphone is no greater than approx. 19 ft/6 m.
- A valid digital key must be set up for the vehicle, then recognized without issue.

Additional information:

Digital Key, refer to page 89.

Parking with Remote Control Parking

1. To perform the parking maneuver with Remote Control Parking, engage selector lever position P.
2. Leave the vehicle and close the doors and cargo area.
3. Open Remote Control Parking in the MINI app and maneuver forward or backward, or select the desired parking method.
4. Follow the instructions on the smartphone.

Stop the vehicle manually if obstacles are present.

Depending on the option selected in the MINI app, either the vehicle is parked at the end of the parking maneuver or control of the vehicle is given back to the driver.

System limits

Due to ambient conditions, e.g., impaired Bluetooth connection transmission due to external faults, Remote Control Parking may be interrupted.

If the power supply of the vehicle battery is not sufficiently ensured, e.g., due to excessive discharge, Remote Control Parking may not be available. Follow the instructions on the MINI app.

It may not be easy to maneuver into a parking space. The function is offered on the MINI app but cannot be used due to ambient conditions.

Back-up assistant

Principle

The Back-up Assistant helps when reversing, e.g., when pulling out of tight or unclear parking or road situations.

The vehicle stores the driving movements of the last distance covered. This stored distance can be driven in reverse with automated steering.

The Back-up Assistant takes control of steering. The driver must control the speed using the accelerator and brake pedals.

With Back-up Assistant: a maximum distance of 164 ft/50 m is saved.

With Reversing Assistant Professional: a maximum distance of 656 ft/200 m is saved.

Vehicle features and options

This system may not be available in the owned vehicle, e.g. due to the selected optional equipment, the national-market version or the option for later enabling and software updates. This also applies to individual functions of the system.

For information on whether a function is currently available in the vehicle or when the function can be installed in the vehicle, contact an authorized service center or another qualified service center or repair shop.

Additional information:

Vehicle equipment, refer to page 8.

General information

Follow the information in the "Parking assistance systems" chapter.

Safety information

Warning

The system cannot serve as a substitute for the driver's personal judgment in assessing the traffic situation. Based on the limits of the system, it cannot independently react to all traffic situations. There is a risk of accident, injury, and property damage. Adjust driving style to traffic conditions. Watch the surrounding traffic situation closely, be ready to take over steering and braking at any time, and actively intervene where appropriate.

Warning

When using the trailer hitch, the assistance system cannot react correctly because the sensors are concealed. There is a risk of accident, injury, and property damage. Do not use the driver assistance system while towing a trailer or when using the trailer hitch, e.g., for a rear bicycle rack.

Warning

The system can steer the vehicle over or onto curbs. There is a risk of injury and risk of property damage. Watch surrounding traffic closely and actively intervene where appropriate

Functional requirements



The following functional requirements apply for the Back-up Assistant:

- Drive forward without interruption to store the distance covered.
- To store the distance covered, do not drive faster than 22 mph/35 km/h.
- No trailer towing.



- Reversing Assistant Professional: sufficiently bright light conditions on the saved route.
- Reversing Assistant Professional: the cameras on the vehicle must be clean and clear.
- Reversing Assistant Professional: The one-off calibration of the camera after vehicle delivery must be complete. Drive a few kilometers in daylight to do so.

Driving in reverse with automated steering

1. To reverse with automatic steering, switch on drive-ready state.
2.  When your vehicle is stopped, press the Park Assist key on the switch cluster or engage reverse gear.
The parking assistance systems view is displayed.
3. On the bottom toolbar, select the following function: "Back-up Assistant".
The length of the saved distance is displayed on the Interaction Unit.
Follow the instructions on the Interaction Unit as necessary.
4. Take your hands off the steering wheel and carefully drive in reverse with the accelerator pedal and the brake.
 The status symbol for the Back-up Assistant illuminates green. The system takes over the steering.
When driving in reverse, observe the vehicle's surroundings.
In case of obstacles, stop immediately and take over control of the vehicle. Follow the instructions for Park Distance Control.
5. Right before the end of the stored distance covered, a signal tone will sound and a message is displayed.

Stop no later than when normal road traffic is reached and take control of the vehicle such as by shifting to forward gear.

Canceling the Back-up Assistant manually

The assisted reversing by the Back-up Assistant can be canceled manually:

- On the bottom toolbar, select the following function: "Cancel".
-  Press the Park Assist key on the switch cluster.

Canceling the Back-up Assistant automatically

The Reversing Assistant is canceled automatically in situations such as the following:

- When the driver grasps the steering wheel or takes over steering.
- When shifting from reverse gear to another selector lever position.
- During activation or intervention by driver assistance systems.
- When exiting the stored lane when reversing, for instance with maximum steering-wheel angle.
- When overlaying messages on the Interaction Unit display.
- In case of a slippery surface.
- When the vehicle is rolling such as on a slope.
- In case of changed ambient conditions.
- When the trailer power socket is occupied or when trailer towing is activated.
- If the vehicle speed exceeds approx. 6 mph/10 km/h.
- Reversing Assistant Professional: if sensor functionality is limited beyond approx. 164 ft/50 m.

System limits

Speed threshold

The maximum speed when reversing is limited to approx. 6 mph/10 km/h.

A warning is issued at a speed of approx. 4 mph/7 km/h.

If the maximum speed is exceeded, the function is interrupted.

Functional limitations

Different influences can lead to side deviations when driving the stored distance covered in reverse. For example, this includes the following factors:

- Steering movements when the vehicle is stationary while storing the distance covered.
- The speed is not adapted to the distance covered.
- Certain road characteristics such as gradients, inclines or slippery road surface.
- Greatly deviating conditions when storing and driving the route, for instance other tires or changed ambient conditions like weather.
- Light conditions changed for Reversing Assistant Professional.

Also follow the information on system limits in the "Parking assistance systems" chapter.



Driving comfort

Vehicle features and options

This chapter describes model-specific equipment, systems, and functions that are currently available, or may become available in the future, even if they are not present in the vehicle.

Additional information:

Vehicle equipment, refer to page 8.

MINI Sound

Depending on vehicle equipment and national-market version, the vehicle drive sound can be adjusted using MINI Sound.

1. To configure MINI Sound, go through the menu as follows: Apps menu / "Vehicle" / "Driving settings" / "Drivetrain and chassis" / "MINI Sound".
2. Select the desired setting.

Climate control

Vehicle features and options

This chapter describes model-specific equipment, systems, and functions that are currently available, or may become available in the future, even if they are not present in the vehicle.

Additional information:







Vehicle equipment, refer to page 8.







Climate control

Overview

Functions in the Climate menu

Some climate control functions, e.g., seat heating or air flow, can be configured using the Climate Control menu on the Interaction Unit.

Icon	Function
	Turn the climate control system on/off.
	Automatic program.
	Temperature.
	Air flow.
	Air distribution.
	Air conditioning.

Icon	Function
	Maximum cooling.
	Air recirculation mode.
	Automatic recirculated-air control.
	Fresh air.
	SYNC program.
	Seat heating.
	Steering wheel heating.

Buttons, automatic climate control



The defrost and rear window heating functions can be turned on/off using the switch cluster.



Icon	Function
	Defrost function.
	Rear window defroster.

Calling up climate control functions

Access the Climate menu via the Interaction Unit:



Select the Climate menu icon on the menu bar.

Or:

Go through the menu as follows: Apps menu / "Vehicle" / "Climate control".

Turning the air conditioning system on/off

The climate control system can be turned on/off using the Interaction Unit.



1. Select the Climate menu icon on the menu bar.



2. Tap the power button.

The entire climate control system is turned on or off with the last settings applied.

When the air conditioning system is turned on, individual climate control functions can be turned off.

Settings

Individual settings for climate control functions, e.g., seat heating intensity, can be configured using the Interaction Unit.

1. To configure the climate control functions individually, select the icon for the Climate Control menu on the menu bar.
2. Tap the settings button.
3. Select the desired setting.

Automatic program

Principle

The automatic program ensures a comfortable climate, which can be modified with the desired temperature and individual settings.

The AUTO program cools, ventilates, and heats the vehicle interior automatically.

Depending on the equipment, the automatic program provides the best possible settings for climate control functions depending on the outside temperature, interior temperature, sunlight, seat occupancy and the desired temperature setting:

- Air flow.
- Air distribution.
- Temperature.
- Seat heating.
- Steering wheel heating.

General information

The automatic program takes seat occupancy into account, regulating the climate in an energy-efficient manner that is tailored to the occupants.

At the same time, a condensation sensor controls the automatic program in order to prevent window condensation to the extent possible.



Overview



- 1 Temperature
Seat heating
Steering wheel heating
- 2 Air flow intensity
- 3 Climate control functions bar
- 4 Settings

Turning the automatic program on/off



The AUTO program can be turned on/off using the Interaction Unit.

1.  Select the Climate menu icon on the menu bar.
2.  Tap the automatic program button.

Setting the intensity

When the automatic program is activated, the intensity of individual climate control

functions, e.g., seat heating, is adjusted individually.

1.  Select the Climate menu icon on the menu bar.
2.  Tap the settings button.
3. Select the desired setting.

Each level has a specific control range of the intensity.

Based on the stored data models, the intensities are dynamically adjusted while driving. It is not necessary to manually change the desired intensity to lower or higher levels while driving.

Custom settings for climate control functions are saved and applied automatically, e.g., after the vehicle is started.

Display

The indicator on the temperature display provides information about the temperature difference between the set desired temperature and the current interior temperature.

- The flashing red or blue bar next to the temperature display indicates that the interior temperature is being adjusted.
- Once the bar stops flashing, the desired interior temperature has been reached.

Temperature

Principle

The automatic climate control cools or heats to the configured temperature and then keeps the temperature constant.

Setting the temperature

The driver and front passenger can each adjust the temperature as they prefer.

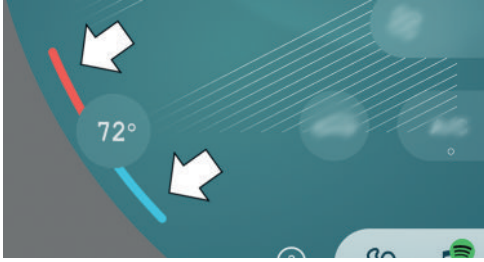

1. Tap the button with temperature display.
2. Set the desired temperature.

Do not rapidly switch between different temperature settings. Otherwise, the automatic climate control will not have sufficient time to adjust the set temperature.

Air flow



Principle

The air flow generated by the blower can be adjusted as needed.

The air flow may be reduced to preserve the vehicle battery.

Adjusting the air flow

The air flow can be configured using the Interaction Unit:

1.  Select the Climate menu icon on the menu bar.
2. Select the desired setting.
 -  Tap the large air flow icon to increase the air flow.
 -  Tap the small air flow icon to reduce the air flow.

Air distribution settings

Principle

The air distribution can be adjusted as required in manual mode.

Adjusting the air distribution

The air distribution can be adjusted via the Interaction Unit:

1.  Select the Climate menu icon on the menu bar.
2. Select the desired setting:
 - Aim the air flow into the footwell, arrow 1.
 - Aim the air flow toward the upper body area, arrow 2.
 - Aim the air flow at the windshield, arrow 3.

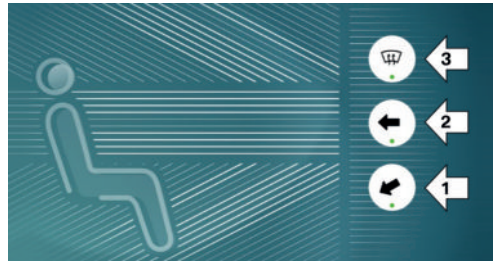

The selected air distribution is displayed.

Air conditioning

Principle



With the climate control function, the air inside the vehicle is cooled and dehumidified, then warmed again depending on the temperature settings.

Functional requirement

The climate control function can be used with standby or drive-ready state.

Switching the cooling function on/off

The air conditioning can be turned on/off using the Interaction Unit:

1.  Select the Climate menu icon on the menu bar.
2.  Tap the climate control function button.

In recirculated-air mode, the air conditioning is automatically turned on to dry the air and avoid window condensation.

Depending on the weather, the windshield and the side windows may fog up briefly when drive-ready state is switched on.

When using the cooling mode, condensation that will exit below the vehicle.

Maximum cooling

Principle

Maximum cooling is used to cool the vehicle interior quickly and effectively.



The lowest temperature and the maximum air flow are set automatically.

Functional requirement

Maximum cooling can be used when the outside temperature exceeds approx. 32 °F/0 °C and when drive-ready state or standby is on.

Turning maximum cooling on/off

Maximum cooling can be turned on/off using the Interaction Unit:

1.  Select the Climate menu icon on the menu bar.
2.  Tap the maximum cooling button.
The air vents open. Air flows out of the air vents to the upper body area.

Air recirculation mode

Principle

With air recirculation, if unpleasant odors or pollutants are detected in the outside air, the outside air supply can be temporarily stopped. The system then recirculates the interior air.

With automatic air recirculation, outside air is fed in, or the interior air is recirculated, depending on the outside air quality.

When air recirculation is off, outside air is channeled into the interior.

The interior filter cleans the incoming fresh air or the circulated interior air in recirculation mode.





General information

If there is window condensation, turn off the air recirculation.



Turning air recirculation on/off

Air recirculation can be turned on/off using the Interaction Unit:

-  Select the Climate menu icon on the menu bar.
- The current operating mode is displayed on the climate control functions bar. Tap the button and select the desired operating mode.
 -  Recirculating air.
 -  Fresh air.
 -  Automatic recirculated-air control.

Depending on vehicle equipment, the air recirculation turns off automatically after some time based on the ambient conditions in order to prevent condensation.

SYNC program

Principle

If the SYNC program is activated, the temperature settings for the driver's side are transferred to the passenger's side.



For improved comfort, when the SYNC program is deactivated, the following settings are adjusted automatically in the automatic program depending on seat occupancy:

If the front passenger seat is unoccupied, the settings for the driver's side are applied to the front passenger side.

When the seat is occupied again, the most recent settings are reapplied.

Turning the SYNC program on/off

The SYNC program can be turned on/off using the Interaction Unit:

-  Select the Climate menu icon on the menu bar.
-  Tap the SYNC program button.

If the temperature settings for the front passenger's side are changed, the SYNC program turns off automatically.

Defrost function

Principle

With the defrost function, ice and condensation are quickly removed from the windshield and the front side windows.

The air flow and air temperature are automatically optimized for the removal of ice and condensation.

The air distribution is directed toward the windshield and front side windows.

If there is window condensation, turn on the automatic program to take advantage of the condensation sensor.

Turning the defrost function on/off

-  To turn the defrost function on/off, press the defrost button on the switch cluster.

The LED of the button is illuminated when the system is switched on.

Make sure that air is able to flow to the windshield and front side windows.

Rear window defroster

Principle

With the rear window defroster, ice and condensation are quickly removed from the rear window.

Functional requirement

The rear window heating can be used when standby or drive-ready state is on.

Turning the rear window defroster on/off



To turn the rear window heating on/off, press the rear window heating button on the switch cluster.

The LED illuminates when the rear window heating is turned on.

The rear window defroster switches off automatically after a certain period of time.

If pre-conditioning is turned on, the rear window defroster is activated as needed.

Seat heating

Principle

When the seat heating is used, seats are heated depending on the outside temperature and the interior temperature.

The intensity can be stored using the automatic program. This function can be adjusted as necessary.

General information

If the trip is continued within approx. 15 minutes after an intermediate stop, the functions are turned on automatically with the temperature that was last set.

Adjusting seat heating

Automatic program

When the automatic program is activated, the intensity of seat heating can be adjusted: As you drive, the heater output is automatically adjusted according to your set intensity.

Adjusting seat heating manually

The heater output level can be adjusted manually:

1. Tap the button with temperature display.



2. Press the seat heating button repeatedly until the desired level is selected, arrow.

If a consumption-optimized drive mode is selected, the heater output is reduced.

Steering wheel heating

Principle

When the steering wheel heating is used, the steering wheel is heated depending on the outside temperature and the interior temperature.

The intensity can be stored using the automatic program. This function can be adjusted as necessary.

Adjusting steering wheel heating

Automatic program

When the automatic program is activated, the intensity of steering wheel heating can be adjusted. As you drive, the heater output is automatically adjusted according to your set intensity.

Adjusting steering wheel heating manually

The heater output level can be adjusted manually:

1. Tap the button with temperature display.



2. Press the steering wheel heating button repeatedly until the desired level is selected, arrow.

If a consumption-optimized drive mode is selected, the heater output is reduced.

Ventilation

Principle

The ventilation system has different options for direct or indirect ventilation to optimize air flow in the vehicle.

The air flow heats or cools noticeably, depending on the set desired temperature.

Front ventilation



- To adjust the air flow direction, push the button in the desired direction.
- To adjust the air flow, turn the knob to open and close the vents variably.

Ventilation in the rear

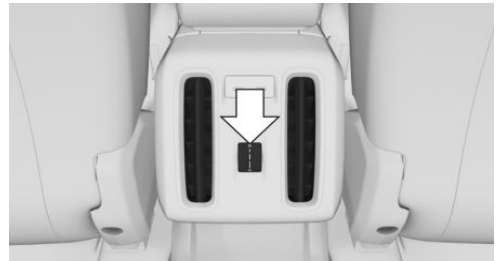

To adjust the air flow, turn the knurled wheel to open and close the vents variably.

Setting the ventilation

Depending on the desired ventilation, align the air flow directly or indirectly toward the passengers.

Open the air vents and position them to ensure effective air conditioning.

Air quality

General information

The following components improve the air quality inside the vehicle:

- Emissions-tested vehicle interior.
- Interior filter.
- Air conditioning system to control the temperature, air flow, and air recirculation.
- Pre-conditioning.

Interior filter

The interior filter cleans the incoming fresh air or the circulated interior air in recirculation mode.

Depending on the equipment:

- Dust and pollen is filtered out from the inflowing air.
- Nano-particle emissions are reduced.
- Gaseous pollutants are filtered.
- Microbial particles, viruses and allergens are filtered.

The manufacturer of the vehicle recommends having the interior filter changed during vehicle maintenance.

Pre-conditioning

Principle

Pre-conditioning cools or heats the vehicle interior to a comfortable temperature prior to departure, depending on the inside/outside temperature. This function makes it easier to remove snow and ice.

The pre-conditioning can be switched on and off directly or via a preset departure time.

Pre-conditioning turns off automatically after approx. 30 minutes or when drive-ready state is activated.

Preconditioning the vehicle while it charges, makes it easier for the climate control system to regulate the temperature while driving. This extends the range.

Functional requirements



The following functional requirements apply for pre-conditioning:

- The vehicle is in idle state or standby state.
- The high-voltage battery is sufficiently charged or the charging process is ongoing.
- If the high-voltage battery is deeply discharged, it may take some time for the pre-conditioning to be ready after the charging process is started.
- Time and date are set correctly.
- The ventilation air vents are open.

Turning on/turning off the pre-conditioning

Turning operating tips on/off via the Interaction Unit

Pre-conditioning can be turned on/off using the Interaction Unit:

1.  Select the Climate menu icon on the menu bar.
2.  Tap the settings button.
3. "Pre-conditioning"
4. Select the desired setting.

Turning on via vehicle key

Pre-conditioning can be turned on using the vehicle key.

1.  Press the lock button on the vehicle key three times within 1 second.
After using the vehicle key, it takes approx. 3 seconds until pre-conditioning turns on.



Automatic switch-off

To ensure the vehicle's minimum range, the preconditioning may turn off automatically, e.g., after repeated activation or because the high-voltage battery has insufficient charge. Charge the high-voltage battery if it turns off due to insufficient charge. The pre-conditioning is then available again.

Air conditioning for departure time

Principle

Departure times can be set with time and day of the week.

The switch-on point is determined automatically based on the temperature.

Pre-conditioning will turn on in time before the set departure time on the desired days.

The departure time is preselected in two steps:



- Set the departure time.
- Activate departure times.

Allow for at least 10 minutes between setting and activating the departure time and departing at the planned time. This gives the air conditioning sufficient time to prepare the vehicle interior.

Pre-conditioning will be turned off automatically a few minutes after the set departure time.

Setting the departure time

The departure time can be set on the Interaction Unit:



1.  Select the Climate menu icon on the menu bar.
2.  Tap the settings button.
3. "Pre-conditioning"
4. "Departure plan"

5. Set the desired departure time.
6. Select the day of the week, as necessary.

Activating the departure time

To turn on the pre-conditioning prior to a departure time, the respective departure time must be activated beforehand.

The departure time can be activated on the Interaction Unit:

1.  Select the Climate menu icon on the menu bar.
2.  Tap the settings button.
3. "Pre-conditioning"
4. "Pre-conditioning for departure"

Activating with the MINI app

Depending on vehicle equipment, the MINI app with remote functionality can be used to turn on pre-conditioning at a preset departure time or immediately.

Interior equipment

Vehicle features and options

This chapter describes model-specific equipment, systems, and functions that are currently available, or may become available in the future, even if they are not present in the vehicle.

Additional information:

Vehicle equipment, refer to page 8.

Sun visor

Glare shield

To prevent glare, fold the sun visor up or down.

Glare shield from the side

Folding the sun visor out

To prevent glare from the side window, proceed as follows:

1. Fold down the sun visor.
2. Detach the sun visor from its mount and swing it toward the side window.

Folding the sun visor in

Proceed in the reverse order to close the sun visor.

Vanity mirror

A vanity mirror is located in the sun visor behind a cover.

Sockets

Principle

The socket can be used for electronic devices when the standby or drive-ready state is switched on.

General information

The total load of all sockets must not exceed 140 watts at 12 volts.

Do not damage the socket by using unsuitable connectors.

Safety information

Warning

Devices and cables in the unfolding area of the airbags such as portable navigation devices can hinder the unfolding of the airbag or be thrown around in the car's interior while unfolding. There is a risk of injury and risk of property damage. Make sure that devices and cables are not in the airbag's area of unfolding.

NOTICE

Battery chargers that charge the vehicle battery via sockets or cigarette lighters in the vehicle may overload or damage the 12 V electrical system. There is a risk of property damage. If the vehicle battery has discharged, contact an authorized service center or another qualified service center or repair shop.

Warning

If metal objects fall or are plugged into electronic interfaces, e.g., sockets or USB ports, these objects can cause a short circuit and destroy the interface. There is a risk of injury and risk of property damage. Make sure to prevent metal objects from falling or being plugged into electronic interfaces. Insert the cigarette lighter or socket cover again after using the socket.

Front center console

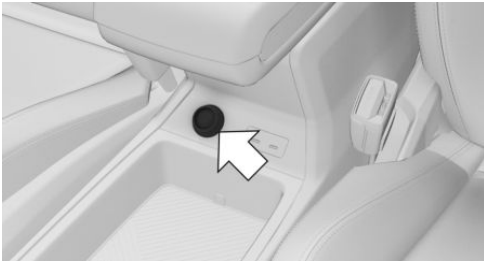

A socket is provided on the center console under a cover. Pull off the cover before using the socket.

In the cargo area



A socket is provided on the right side of the cargo area under a cover. Open the cover before using the socket.

USB port

Principle

Mobile devices can be charged via USB cable using the USB port.

Safety information

Warning

If metal objects fall or are plugged into electronic interfaces, e.g., sockets or USB ports, these objects can cause a short circuit and destroy the interface. There is a risk of injury and risk of property damage. Make sure to prevent metal objects from falling or being plugged into electronic interfaces. Insert the cigarette lighter or socket cover again after using the socket.

Front center console

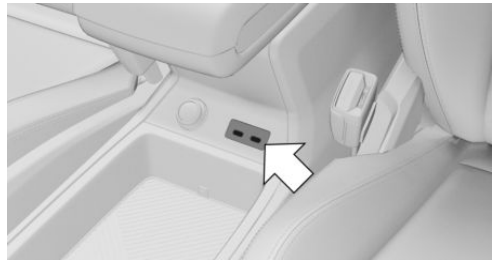

Two USB ports are located on the front center console.

Properties:

- USB port Type C.
- For charging mobile devices.
- Charge current: maximum 3 A per port.

Rear center console

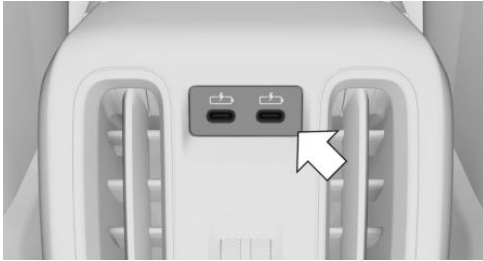

Two USB ports are located in the rear center console.

Properties:

- USB port Type C.
- For charging mobile devices.
- Charge current: maximum 3 A per port.

Wireless charging tray

Principle

The wireless charging tray is used to wirelessly charge Qi-certified smartphones.

General information

Quick charging functions are supported depending on the smartphone.

The integrated fan cools the smartphone being charged.

When inserting the smartphone to be charged, make sure that there is nothing between the smartphone to be charged and the wireless charging tray.

⚡ The charging process is shown by the charge indicator on the Interaction Unit.

Safety information

Warning

When charging a Qi-compatible device in the wireless charging tray, any metal objects on the tray together with the device can become very hot. Storage media or electronic cards, e.g., chip cards, cards with magnetic strips, or cards for transmitting signals, may not function correctly when placed together on the tray with the device. There is a risk of injury and risk of property damage. When charging mobile devices, make sure there are no objects on the tray together with the device.

Overview

The wireless charging tray is located in the center console.

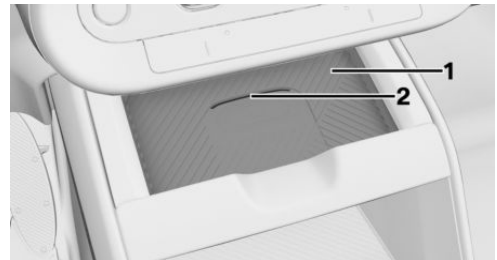

- 1 Storage area
- 2 Fan

Functional requirements

The following functional requirements apply for the wireless charging tray:

- The smartphone to be charged must be Qi-certified.
- Standby state is switched on.
- The charging function is on.



- The smartphone cannot exceed maximum dimensions of approx. 6.69 x 3.34 x 0.7 in/170 x 85 x 18 mm.
- Protective sleeves and covers must be suitable for wireless charging.
- The smartphone to be charged is located in the center of the tray. The smartphone display is facing up.

Activating/deactivating charging

To activate/deactivate charging, go through the menu as follows: Apps menu / "Vehicle" / "System settings" / "Wireless charging tray" / "Wireless charging".

Inserting a smartphone

Place the smartphone in the middle of the tray, with the display facing up.

Forgotten warning

General information

A warning may be issued if a Qi-certified smartphone was forgotten in the wireless charging tray when leaving the vehicle.

The Forgotten Warning is displayed on the Interaction Unit.

Enable/Disable Forgotten Warning

To activate/deactivate the Forgotten Warning, go through the menu as follows: Apps menu / "Vehicle" / "System settings" / "Wireless charging tray" / "Mobile phone reminder".

System limits

The charge current may be reduced or charging may be temporarily interrupted in the wireless charging tray in the following situations:

- Due to excessive temperatures on the tray and smartphone.
- If there are objects between the smartphone and wireless charging tray.
- If storage media or electronic cards, e.g., chip cards, cards with magnetic strips, or cards for signal transmission, are located between the smartphone and wireless charging tray.
- Due to protective sleeves and covers that exceed a thickness of 0.07 in/2 mm
- Due to protective sleeves and covers made of unsuitable material, e.g., with magnetic parts.
- Due to add-on parts for the smartphone, e.g., holders.
- By configuring the smartphone settings, e.g., for charging. Follow the instructions given on the Interaction Unit and smartphone, where applicable.

Interior camera

Principle

The interior camera can be used to record the vehicle interior.

Prior to the first use of the interior camera, the recording function and, if necessary, data transfer must be activated. To do so, confirm on the Interaction Unit. Additional activation may be required for some system functions.

Two infrared light sources next to the camera lens illuminate while the interior camera is active. Infrared light sources may be visible, depending on lighting conditions.

The interior camera can provide the following functions:

- Interior camera.

- Media can be recorded, saved, and played.
- Remote Inside View.
The vehicle interior can be recorded using the MINI app.
- Anti-theft recorder.
If the alarm system is triggered, the vehicle interior is automatically recorded. Recordings can be shown using the MINI app.

Follow applicable legal requirements when using this system.

Data protection

General information

The permissibility of making and evaluating recordings for the interior camera depends on the applicable regulations of the country in which the system is to be used. The user is responsible for the use of the system and compliance with the respective regulations.

The vehicle manufacturer recommends that you verify there are no statutory or regulatory restrictions on using the system in your region or country prior to initial use. In addition, the laws with respect to use of the system should be verified in regular intervals, especially when borders are frequently crossed.

Other users and occupants of the vehicle must be informed about the system. In addition, information about the system is required when handing off the vehicle.

Data transfer and data storage

Whether recording data will be sent or stored depends on the recording function.

The following applies for the interior camera function:

- Data is sent to a mobile device. It must be possible to connect to the vehicle over Wi-Fi.
- Data is saved to the vehicle and assigned to the MINI ID or driver profile.

The following applies for Remote Inside View:

- Data is sent to a mobile device via the MINI app. The MINI app must be linked to the MINI Connected account.
- Data is saved to the MINI app and, after data is sent, to the mobile device.

The following applies for the Anti-Theft Recorder:

- Data is sent to a mobile device via the MINI app. The MINI app must be linked to the MINI Connected account.
- Data is saved to the vehicle and, after data is sent, to the mobile device.

More information on the scope and content of data processing is available online in the MINI Connected privacy notices or service descriptions.

Occupying the seats

The interior camera is also used to detect occupied seats.

The interior camera turns on automatically at regular intervals when all doors are closed. This system analyzes the vehicle interior to detect which seats are occupied. No media recordings are made in the process.

Overview

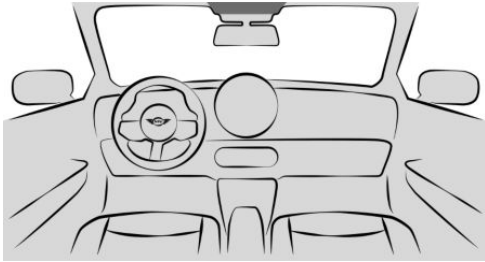

The interior camera is located in the headliner.

Additional information:

Around the headliner, refer to page 39.

Functional requirements

The following functional requirements apply for the interior camera function:

- The Privacy Policy has been accepted.
- The camera is activated.

When sending recordings to mobile devices, the following functional requirements apply:

- Data transfer is activated.
- A mobile device is connected to the vehicle via Wi-Fi.

The following functional requirements apply for the Remote Inside View and Anti-Theft Recorder functions:

- The Privacy Policy has been accepted.
- The MINI app is installed on the mobile device.
- The MINI app is linked to the MINI Connected account.
- The vehicle is parked and locked.
- The Anti-Theft Recorder can only be used if vehicle is equipped with an alarm system.

Ensure that the faces of occupants are visible and are not partially or completely covered, for instance by face masks.

Additional information:

Data protection, refer to page 66.

Activating/deactivating interior camera

The interior camera can record and send data when activated, then be deactivated.

1. Go through the menu as follows: Apps menu / "All" / "Interior camera" / "Settings".
2. Select the desired setting.

Interior camera

Recording mode

Recording mode	Function
"Single photo"	Shortly after triggering, a photo will be taken.
"Smile"	When the system detects a smile, a picture will be taken.
"Self-timer (3 sec.)"	After the timer has expired, a photo will be taken.
"Burst mode"	Shortly after triggering, a series of pictures will be taken.

Take picture

A photo can be taken as follows:

1. Go through the menu as follows: Apps menu / "All" / "Interior camera" / "Camera".
2. Select the desired recording mode.
3. Trigger a photo.

Depending on the recording mode selected, photos are taken shortly after being triggered, when a smile is detected, or when the timer elapses.

For burst shots, the series of pictures will be displayed as a preview.

Recording video

Videos can be recorded as follows:

1. Go through the menu as follows: Apps menu / "All" / "Interior camera" / "Camera".
2. Select the recording mode for video recording.
3. Start the video recording.
You can only record video for a certain time.

Displaying and managing recordings

Saved recordings can be played, sent, and deleted in the vehicle.

In some national-market versions, recordings are only shown on the Interaction Unit for up to approx. 2 mph/3 km/h for safety purposes.

1. Go through the menu as follows: Apps menu / "All" / "Interior camera" / "Gallery".
2. Select the desired recording.
3. Select the desired setting.

Scan the QR code shown on the Interaction Unit to send recordings to a mobile device. The recording is transferred when the pop-up on the mobile device is opened. The mobile device must be connected to the vehicle via WLAN.

Settings

1. To configure the settings for the interior camera, go through the menu as follows: Apps menu / "All" / "Interior camera" / "Settings".
2. Select the desired setting.

Remote Inside View

With Remote Inside View, recordings of the vehicle interior can be played on a mobile device using the MINI app. The vehicle interior can be checked, e.g., for forgotten items.

The function is not suitable for monitoring people or animals left behind.

Anti-theft recorder

The Anti-Theft Recorder automatically records the vehicle interior when the alarm system is triggered. The MINI app sends a notification when a recording is being taken. The recording can be shown on a mobile device.

Up to three media recordings can be saved to the vehicle and synchronized with the MINI app. If the vehicle is reset to factory settings, recordings saved to the vehicle are deleted.

Storage compartments

Vehicle features and options

This chapter describes model-specific equipment, systems, and functions that are currently available, or may become available in the future, even if they are not present in the vehicle.

Additional information:

Vehicle equipment, refer to page 8.

Storage compartments

Principle

The vehicle has various options for storing or stowing objects, e.g., the glove compartment or door storage compartments.

Safety information

Warning

When driving, loose items or devices connected to the vehicle with a cable, i.e., mobile phones, may be thrown around the vehicle, e.g., in the event of an accident or when braking or performing evasive maneuvers. There is a risk of injury and risk of property damage. Secure loose objects or devices that are connected to the vehicle via a cable.

Warning

Open flaps of the storage compartments, e.g., glove compartment or center armrest, protrude into the interior when folded open and may be in the way of an airbag that deploys. In addition, objects in the open storage compartment can be thrown

into the vehicle interior during the trip, for instance, in the event of an accident or when braking or making an evasive maneuver. There is a risk of injury. Always close storage compartments immediately after use.

Warning

Anti-slip pads such as anti-slip mats can damage the dashboard. Attached objects could come loose. There is a risk of injury and risk of property damage. Do not use anti-slip pads.

Glove compartment

Overview

The glove compartment is located at the bottom of the instrument panel on the front passenger's side.

Opening the glove compartment



Pull the handle on the glove compartment.

Closing the glove compartment

To close the glove compartment, press the glove compartment lid down until it engages.

Locking the glove compartment

The glove compartment can be locked with an integrated key. This prevents access to the glove compartment.

After the glove compartment has been locked, the vehicle key can be given to someone without the integrated key, for example, when the car is being parked by a parking attendant.

Additional information:

Integrated key, refer to page [74](#).

Storage compartments in the doors

Safety information

Warning

Breakable objects such as glass bottles or glasses can break in the event of an accident, braking or an evasive maneuver. Broken glass can be scattered in the car's interior. There is a risk of injury and risk of property damage. Do not use any breakable objects while driving. Only stow breakable objects in closed storage compartments.

Overview

The storage compartments are located in the doors.

Storage tray in center console

Overview

The storage compartments are located in the center console.

Additional information:

Wireless charging tray, refer to page [295](#).

Opening the storage compartment

To open the storage compartment, proceed as follows:

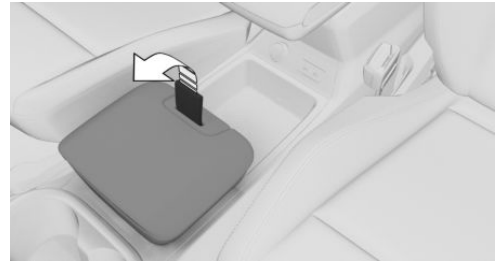

Use the loop on the storage compartment to open the lid, arrow.

Closing the storage compartment

To close the storage compartment, press the lid down until it engages.

Front cup holder

Safety information

Warning

Unsuitable containers in the cup holders may damage the cup holders or be thrown about the car's interior in the event of an accident, an evasive maneuver, or forceful braking. Spilled liquids can distract from the surrounding traffic conditions, lead to an accident and damage vehicle components. Hot drinks can damage the

cup holder or lead to scalding. There is a risk of injury and risk of property damage. Do not force objects into the cup holder. Make sure that drink containers are secured firmly in the cup holder. Use lightweight, shatterproof, and sealable containers. Clean up spilled liquids immediately. Do not transport hot beverages.

Overview

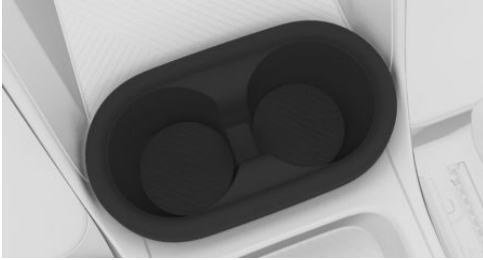

The center console includes two cup holders.

Rear cup holder

Safety information

Warning

Unsuitable containers in the cup holders may damage the cup holders or be thrown about the car's interior in the event of an accident, an evasive maneuver, or forceful braking. Spilled liquids can distract from the surrounding traffic conditions, lead to an accident and damage vehicle components. Hot drinks can damage the cup holder or lead to scalding. There is a risk of injury and risk of property damage. Do not force objects into the cup holder. Make sure that drink containers are secured firmly in the cup holder. Use lightweight, shatterproof, and sealable contain-

ers. Clean up spilled liquids immediately. Do not transport hot beverages.

Overview

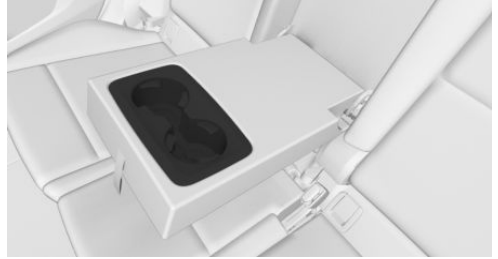

Two cup holders are provided in the rear center armrest.

Coat hooks

Safety information

Warning

Clothing articles on the coat hooks can obstruct the view while driving. There is a risk of accident, injury, and property damage. When suspending clothing articles from the coat hooks, ensure that they will not obstruct the driver's view.

Warning

Improper use of the coat hooks can lead to a risk of objects flying about during braking and evasive maneuvers. There is a risk of injury and risk of property damage. Only hang lightweight objects, for instance clothing articles, from the coat hooks.



Overview

The coat hooks are located on the rear grab handles in the headliner.



Cargo area

Vehicle features and options

This chapter describes model-specific equipment, systems, and functions that are currently available, or may become available in the future, even if they are not present in the vehicle.

Additional information:

Vehicle equipment, refer to page 8.

Loading

Principle

When loading the vehicle, items and cargo must be stowed and secured properly. Do not exceed the permissible weights and loads.

Safety information

Warning

High gross vehicle weight can overheat the tires, damage them internally and cause a sudden tire pressure loss. Driving characteristics may be negatively impacted, reducing directional stability, lengthening the braking distances and changing the steering response. There is a risk of accident, injury, and property damage. Pay attention to the permitted load-carrying capacity of the tires and never exceed the permitted gross vehicle weight.

Warning

When driving, loose items or devices connected to the vehicle with a cable, i.e., mobile phones, may be thrown around the vehicle, e.g., in the event of an accident or when braking or performing evasive maneuvers. There is a risk of injury and risk of property damage. Secure loose objects or devices that are connected to the vehicle via a cable.

Warning

Improperly stowed objects can slip and be thrown into the car's interior, for instance in the event of an accident, braking or an evasive maneuver. Vehicle occupants can be hit and injured. There is a risk of injury and risk of property damage. Stow and secure objects and cargo properly.

NOTICE

Fluids in the cargo area can cause damage. There is a risk of property damage. Make sure that no fluids leak in the cargo area.

Steps for determining correct load limit

1. Locate the statement “The combined weight of occupants and cargo should never exceed XXX kg or XXX lbs” on the vehicle’s placard.
2. Determine the combined weight of the driver and passengers that will be riding in the vehicle.

3. Subtract the combined weight of the driver and passengers from XXX kg or XXX lbs.
 4. The resulting figure equals the available amount of cargo and luggage load capacity. For example, if the “XXX” amount equals 1,400 lbs and there will be five 150 lbs passengers in the vehicle, the amount of available cargo and luggage load capacity is 650 lbs (1,400 - 750 (5 x 150) = 650 lbs).
 5. Determine the combined weight of luggage and cargo being loaded on the vehicle. That weight may not safely exceed the available cargo and luggage load capacity calculated in Step 4.
 6. If the vehicle will be towing a trailer, load from your trailer will be transferred to the vehicle. Consult this manual to determine how this reduces the available cargo and luggage load capacity of the vehicle.
- Cover sharp edges and corners on the cargo.
 - Do not stack cargo above the upper edge of the backrests.
 - If stowing sufficiently large items in the cargo area, fold down the rear seat backrests completely.
 - Fasten straps, etc. for securing the load to the lashing eyes in the cargo area.
 - Small, light-weight cargo: Secure with tensioning/draw straps or with a cargo net.
 - Larger, heavy cargo: Secure with cargo straps.
 - Stow particularly heavy cargo as far forward as possible, directly behind and below the rear seat backrests. When the rear seat is not occupied, secure each of the outer seat belts in the opposite buckle.

Payload

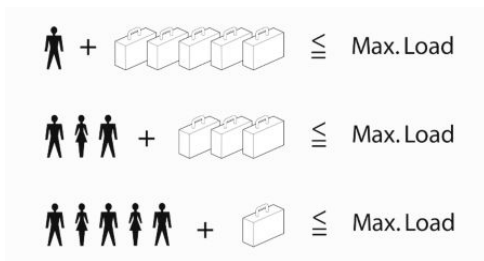

The maximum permissible payload is the sum of the weight of all occupants and the cargo.

The greater the weight of the occupants, the less cargo that can be transported.

Stowing and securing cargo

To stow and secure cargo, note the following:

Lashing eyes in the cargo area

Principle

Lashing eyes are devices used to secure loads. Depending on vehicle equipment, two lashing eyes are provided in the cargo area.

General information

To secure cargo, attach suitable devices, e.g., lashing straps, tensioning straps, draw straps, or cargo nets, to the lashing eyes.



Overview



The lashing eyes are located on the side panels in the cargo area.

Multifunction hook

Principle

Light-weight objects can be hung on the multifunction hooks in the cargo area.

Safety information

Warning

Improper use of the multifunction hooks can lead to a risk of objects flying about, e.g., during braking and evasive maneuvers. There is a risk of injury and risk of property damage. Only hang lightweight objects from the multifunction hooks. Heavy luggage in the cargo area must be properly secured.

Overview

Depending on vehicle equipment, multifunction hooks are provided on the left and right side of the cargo area.

Net

Depending on vehicle equipment, there is a net on the left side of the cargo area.

Smaller items can be stored in the net. To transport larger objects, slide the net down.

Storage compartment on the right side

There is a storage compartment on the right side of the cargo area.

Cargo floor panel

Principle

To stow cargo, a storage compartment is provided under the cargo area floor. The cargo area floor can be folded up and removed.

Safety information

Warning

Improper use of the cargo area floor can lead to a risk of objects flying about during braking and evasive maneuvers, for example. There is a risk of injury and risk of property damage.

- Do not use the cargo area floor to separate the cargo area and vehicle interior in the sense of a luggage net.
- Only use the cargo area floor in the folded-up position when the rear seat backrests are folded up and locked.

- Fold down the cargo area floor before driving off.
- Always secure cargo against slipping, using straps, belts and lashing eyes, for instance.

NOTICE

The storage space under the cargo area floor is only suitable for soft objects. Hard objects may result in damage to the vehicle electrical system in the event of an accident. There is a risk of property damage. Only stow soft objects under the cargo area floor.

Opening the storage compartment

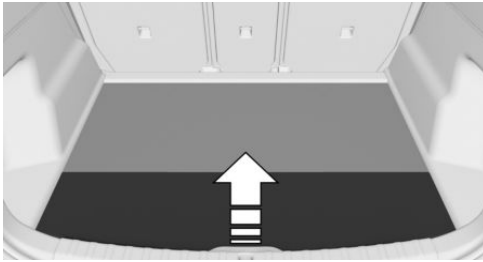

To open the storage compartment, grip the rear edge of the cargo area floor and fold it forward.

Fold up the cargo area floor

The cargo area floor can be folded up as follows:

1. Fold the rear part of the cargo area floor forward.
2. Fold up the cargo area floor if it has been folded forward.



Removing the cargo floor panel

The cargo area floor can be removed as follows:

1. Fold the rear part of the cargo floor panel forward.
2. Slightly raise the cargo area floor.
3. Pull the cargo area floor backward, out of the mounts, then remove.

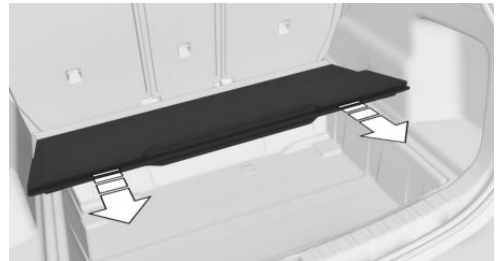



Inserting the cargo floor panel

Proceed in reverse order to insert the cargo area floor:

1. Place the folded cargo area floor flat against the mounts.
2. Push the cargo area floor forward into the mounts. The cargo area floor engages noticeably.

Enlarging the cargo area

Principle

Depending on vehicle equipment version, the cargo area can be enlarged as follows:

- The rear seat backrests can be moved into an upright loading position using the cargo setting.
- The rear seat backrests can be folded down.

General information

The rear seat backrest is divided at a ratio of 40–20–40. The side rear seat backrests and the center section can be folded down separately.

The rear seat backrests can be folded down from the rear.

Safety information

Warning

There is a danger of jamming with folding down the rear seat backrests. There is a risk of injury and risk of property damage. Make sure that the area of movement of the rear seat backrest and the of the head restraint is clear prior to folding down.

Warning

If a rear seat backrest is not locked, unsecured cargo can be thrown about the car's interior; for instance, in the event of an accident, braking or an evasive maneuver. There is a risk of injury. Make sure that the rear seat backrest is locked after folding it back.

Warning

The stability of the child restraint system is limited or compromised with incorrect seat setting or improper installation of the child seat. There is a risk of injury or danger to life. Make sure that the child restraint system fits securely against the backrest. If possible, adjust the backrest tilt for all affected backrests and correctly adjust the seats. Make sure that seats and backrests are securely engaged or locked. If possible and necessary, adjust the height of the head restraints or remove them.

Cargo position

Principle

The rear seat backrests can be moved into an upright loading position individually. An adjustment in several tilt stages is possible as needed.

Adjusting

To adjust the loading position of the rear seat backrests, proceed as follows:

1. Pull the loop on the side of the seat.



2. Set the loading position of the rear seat backrest as required.
3. Engage the rear seat backrest.

Folding down the rear seat backrest

To fold in the rear seat backrests, proceed as follows:



Pull the loop on the side of the seat and fold the rear seat backrest forward.

Folding back the backrest

To fold back the rear seat backrests, proceed as follows:

1. Fold the rear seat backrest down. The rear seat backrest first engages in the loading position.
2. Pull the loop on the side of the seat.

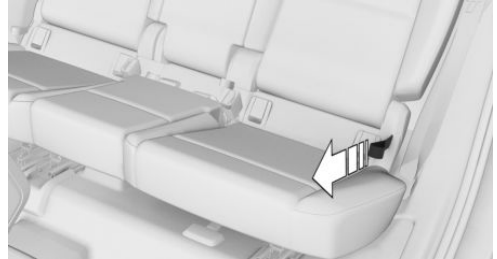

3. Return the rear seat backrest to the seat position and engage it.

Cargo cover

Principle

The cargo cover separates the cargo area from the seat rows and is used to secure cargo. The cargo cover can be removed.

Safety information

Warning

When driving, loose items or devices connected to the vehicle with a cable, i.e., mobile phones, may be thrown around the vehicle, e.g., in the event of an accident or when braking or performing evasive maneuvers. There is a risk of injury and risk of property damage. Secure loose objects or devices that are connected to the vehicle via a cable.

⚠ Warning

An incorrectly inserted cargo cover can be thrown about the car's interior such as in the event of an accident or a braking or evasive maneuver. There is a risk of injury and risk of property damage. Make sure the cargo cover is securely engaged in the brackets.

⚠ Warning

Body parts can become trapped when the folding cargo cover is operated. There is a risk of injury. When operating the folding cargo cover, make sure that the travel path of the cover is clear.

Removing the cargo cover

The cover can be removed to load bulky luggage.

1. Detach the retaining straps on the tailgate.
2. Grasp the cover with both hands on the rear edge and lift slightly, arrow 1.

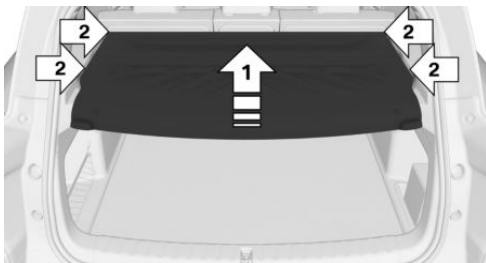

3. Firmly pull the cover backward out of the brackets, arrows 2.

Inserting the cargo cover

Install the cargo cover in reverse order. Make sure that the cargo cover is positioned correctly in the brackets and that it is engaged.



Things to remember when driving

Vehicle features and options

This chapter describes model-specific equipment, systems, and functions that are currently available, or may become available in the future, even if they are not present in the vehicle.

Additional information:

Vehicle equipment, refer to page 8.

Break-in procedures

General information

Moving parts need to work together smoothly.

The following break-in procedures will help the vehicle achieve a long service life and good efficiency.

During break-in, do not use the Launch Control.

Safety information

Warning

Due to new parts and components, safety and driver assistance systems can react with a delay. There is a risk of accident, injury, and property damage. After installing new parts or with a new vehicle, drive conservatively and intervene early if necessary. Observe the break-in procedures of the respective parts and components.

Drive system

Drive restrained for the first 300 miles/500 km and avoid full load.

Tires

Tire traction is not optimal due to manufacturing circumstances when tires are brand new.

Drive conservatively for the first 200 miles/300 km.

Brake system

Brake disks and brake pads must be broken in to avoid the conditions that can lead to brake noise. Drive carefully for the first approx. 300 miles/500 km.

Following part replacement

Observe the break-in procedures again if components mentioned above are replaced.

General driving notes

Closing the tailgate

Safety information

Warning

An open tailgate protrudes from the vehicle and can endanger occupants and other road users or damage the vehicle in the event of an accident, braking or evasive maneuvers. In addition, water may enter the vehicle interior. There is a risk of injury and risk of property damage. Do not drive with the tailgate open.

Driving with the tailgate open

If the vehicle still needs to be driven with the tailgate open:

- Close all windows and the glass sunroof.
- Greatly increase the blower output.
- Drive moderately.
- Secure the tailgate, e.g., with a tensioning belt.

Ground clearance

⚠ NOTICE

If the ground clearance is insufficient, e.g., underground garage entrances, speed bumps, or curbs, the ground may come into contact with vehicle parts, e.g., spoiler, and the underbody. There is a risk of property damage. Ensure that there is sufficient ground clearance available. Adjust your driving style to the respective conditions.

Driving at high speeds

⚠ Warning

Damage to vehicle components can negatively impact handling at high speeds. This includes, among other things, tires, underbody and parts for improving aerodynamics. There is a risk of accident, injury, and property damage. Have damage corrected by an authorized service center or another qualified service center or repair shop. Do not drive at high speeds until the damage is corrected.

Mobile communications in the vehicle

⚠ Warning

Vehicle electronics and mobile communication devices can influence one another. There is radiation due to the transmission operations of mobile communication devices.

There is a risk of injury and risk of property damage. If possible, only use mobile communication devices, e.g., mobile phones, when connected directly to an external antenna or Personal eSIM in order to prevent mutual interference and to deflect radiation from the vehicle interior.

Aquaplaning

On wet or slushy roads, a wedge of water can form between the tires and road surface.

This phenomenon is referred to as aquaplaning. It is characterized by a partial or complete loss of contact between the tires and the road surface, ultimately undermining your ability to steer and brake the vehicle.

Driving through water

General information

When driving through water, note the following:

- Drive through calm water only.
- Drive through water only up to a maximum height of 9.8 inches/25 cm.
- Drive through water at walking speed, max. 3 mph/5 km/h.

Safety information

⚠ NOTICE

When driving too quickly through deep water, the water can penetrate under the hood, into the electrical system or into the transmission. There is a risk of property damage. When driving through water, do not exceed the maximum indicated water level and the maximum speed for driving through water.

Braking safely

General information

The vehicle is equipped with an Antilock Braking System as a standard feature.

Perform full braking when appropriate. To achieve the best possible braking assistance, do not reduce the pressure on the brake pedal during full braking.

Steering is still responsive. You can still avoid any obstacles with a minimum of steering movement.

Sounds from the hydraulic circuits indicate that the Antilock Braking System is regulating.

Objects in the travel path of the pedals

Warning

Objects in the driver's footwell can limit the pedal travel or block a depressed pedal. There is a risk of accident, injury, and property damage. Stow objects in the vehicle such that they are secured and cannot enter into the driver's footwell. Use floor mats that are suitable for the vehicle and can be safely attached to the floor. Do not use loose floor mats and do not layer several floor mats. Make sure that there is sufficient clearance for the pedals. Ensure that the floor mats are securely fastened again after they were removed, for instance for cleaning.

Pedal feel when driving off

After turning on drive-ready state from idle state, the pedal may feel unusual, e.g., the pedal travel path may feel short or long. After the brake pedal has been fully released, the pedal will feel as usual again.

Driving in wet conditions

In case of wet roads, exposure to road salt or in heavy rain, gently depress the brake pedal every few kilometers. Ensure that this action does not endanger other road users.

The heat generated while braking dries brake disks and brake pads and protects them against corrosion.

In this way the brake power will be available when you need it.

Hills

General information

The braking effect of the drive system can be influenced by the energy recovery process.

Safety information

Warning

Light but constant pressure on the brake pedal can lead to high temperatures, brake wear, and even failure of the brake system. There is a risk of accident, injury, and property damage. Avoid placing excessive stress on the brake system.

Warning

In Neutral or with drive-ready state switched off, safety functions, for instance engine braking effect, braking assistance and steering assistance, may be restricted or not available. There is a risk of accident, injury, and property damage. Do not attempt to drive in Neutral or with drive-ready state switched off.

Brake disk corrosion

Corrosion on the brake disks and contamination on the brake pads are increased by the following circumstances:

- Low mileage.
- Extended stationary periods.
- Low load.
- Aggressive, acidic, or alkaline cleaning agents.

Corrosion buildup on the brake disks will cause a pulsating effect on the brakes when braking slowly - generally this cannot be corrected.

Condensation water under the parked vehicle

When using the automatic climate control, condensation water develops and collects underneath the vehicle.

Driving on poor roads

Principle

Because of its greater ground clearance, the vehicle can be driven on a variety of road types and qualities.

All-wheel drive can help improve drive power.

Safety information

NOTICE

Objects in unpaved areas, for instance stones or branches, can damage the vehicle. There is a risk of property damage. Do not drive on unpaved terrain.

When driving on poor roads

For your own safety and the safety of passengers as well as your vehicle, when driving on poor-quality roads, note the following:

- Familiarize yourself with the vehicle before driving off.
- Do not take risks when driving.
- Adjust the speed to the road surface conditions. The steeper and more uneven the road, the slower your speed should be.
- For steep downhill driving, use Hill Descent Control.
- Do not allow the vehicle body or underbody to come into contact with the ground.
- To ensure the best possible traction when driving off, activate driving off support as necessary.

Additional information:

- Hill Descent Control, refer to page [219](#).
- Drive-off support, refer to page [219](#).

After a trip on poor roads

To ensure driving safety, check the wheels and tires for damage after driving on poor-quality roads. Clear heavy soiling from the body.

If the vehicle body or floor has come into contact with the ground, have the vehicle checked by an authorized service center or another qualified service center or repair shop.

Driving on racetracks

Warning

The vehicle is not designed for use in M Sport or motorsport-like competition. There is a risk of accident, injury, and property damage. Do not use the vehicle for M Sport or motorsport-like competitions.

Higher mechanical and thermal loads during racetrack operation lead to increased wear. Use of the vehicle in M Sport or motor sport type competition is an improper use of the vehicle and may affect your warranty coverage. Please consult the New Vehicle Limited Warranty Booklet for further information on warranty matters.

The vehicle manufacturer recommends using special sport tires, e.g., high-performance tires. Sports tires are matched to the special requirements of a sporty driving style. For more information on sport tires, contact an authorized service center or another qualified service center or repair shop.

Before and after driving on a racetrack, have the vehicle checked by an authorized service center or another qualified service center or repair shop.

Roof bars

Principle

Roof bars are devices that are mounted on the vehicle to facilitate the transport of luggage. When driving with a roof bar, various specifications, e.g., correct load, must be followed.

General information

The roof bar can only be installed if the vehicle has a roof rail.

Roof racks are available as optional accessories.

Safety information

Warning

When driving with a roof load, e.g., roof bars, the vehicle's center of gravity is higher. This increases the risk of the vehicle tipping in critical driving situations. There is a risk of accident, injury, and property damage. Drive with roof load only with activated Dynamic Stability Control.

Installation

Follow the installation instructions for roof bars when installing.

Be sure that adequate clearance is maintained for tilting and opening the glass sunroof.

Loading

Because roof racks raise the vehicle's center of gravity when loaded, they have a significant effect on vehicle handling and steering. When loading and driving, note the following:

- Do not exceed the permissible roof load, axle load, and gross vehicle weight.
- Distribute the roof load evenly.
- The roof load should not extend past the vehicle sides.
- Always place the heaviest pieces on the bottom.
- Secure roof luggage firmly, for instance using tie-down straps.

- Do not let objects project into the swiveling range of the tailgate.
- Drive carefully. Do not drive off or brake suddenly or take corners at speed.

Trailer and rear carrier

Vehicle features and options

This chapter describes model-specific equipment, systems, and functions that are currently available, or may become available in the future, even if they are not present in the vehicle.

Additional information:

Vehicle equipment, refer to page [8](#).

Using trailers and rear carriers

Principle

The trailer and rear carrier, e.g., rear bicycle rack, can be connected to the vehicle. When driving with a trailer or rear carrier, you must follow certain values and specifications for drawbar nose weight, load, tire pressure, exterior mirrors, and electrical consumption.

General information

The permissible trailer loads, the axle loads, the drawbar nose weights, and the permissible gross vehicle weight are specified in the technical data.

Drawbar nose weight

The maximum payload of the towing vehicle is reduced by the weight of the trailer hitch and the drawbar nose weight. The drawbar nose weight increases the vehicle weight. Do not exceed the approved gross vehicle weight of the towing vehicle.

Loading

To load the trailer, distribute the cargo as evenly as possible over the loading surface.

Stow the cargo as low and close to the trailer axle as possible. A low center of gravity in the trailer increases the driving safety of the entire trailer.

Do not exceed the approved gross vehicle weight of the trailer and the permissible trailer load of the vehicle. The smaller value applies in each case.

Tire pressure

When towing a trailer, follow the tire pressure specifications for the vehicle and trailer.

For the vehicle, the tire inflation pressure for higher loads applies.

For the trailer, the specifications of the manufacturer apply.

After correcting the tire pressure or connecting or disconnecting a trailer, reinitialize the Flat Tire Monitor or reset the Tire Pressure Monitor.

Additional information:

- Tire pressure specifications, refer to page [347](#).
- Flat tire monitor, refer to page [366](#).
- Tire pressure monitor, refer to page [359](#).

Exterior mirrors

Exterior mirrors, which bring both rear edges of the trailer into the driver's field of vision, are available as optional accessories from an authorized service center or another qualified service center or repair shop.

Electrical consumption

General information

To preserve the vehicle battery and reduce electrical consumption, keep the switch-on times of power consumers short during camper operation.

Trailer lighting

Before starting a drive, make sure that the trailer lighting is working properly.

The output of the trailer lighting should not exceed:

- Turn signals/brake lights: 54 watts per side.
- Tail lights: 100 watts total.
- Reversing lights: 54 watts in total.

Care for trailer hitch mount

Depending on vehicle equipment, keep the trailer hitch mount clean.

Regularly treat the bearing points and sliding surfaces with resin-free grease or oil.

Before using steam/high-pressure cleaners on the vehicle, remove the ball head and insert the cover into the mount.

Mount for trailer hitch

Principle

The trailer hitch mount is located at the rear of the vehicle and is used to mount a trailer hitch.

General information

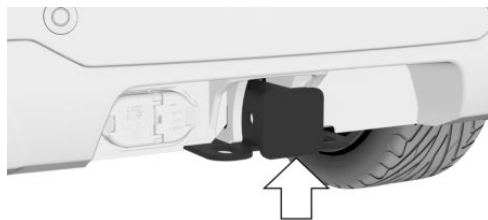

The mount for the trailer hitch is located on the rear of the vehicle, see arrow.

Information on suitable trailer hitches is provided on the underside of the mount cross member.

Follow the instructions for maintaining the trailer hitch mount.

Additional information:

Caring for special components, refer to page 395.

Safety information

Warning

When driving, high temperatures can occur underneath the vehicle body, e.g., due to the exhaust system, brakes or radiator. Contact with the hot components can cause burns. There is a risk of injury. Do not touch hot components. Do not perform work in the vicinity of hot components until after they have cooled down.

Removing the cover

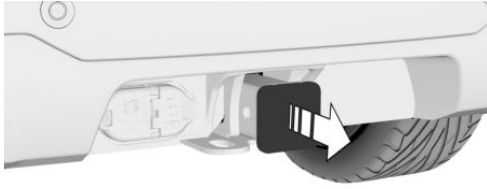

Pull the cover to the rear out of the mount and stow it in your vehicle.

Trailer power socket

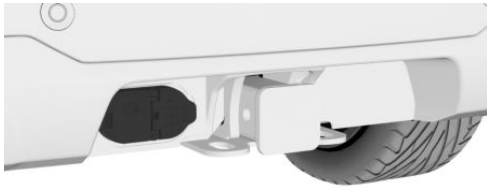

The trailer power socket is located to the left of the trailer hitch mount.

Loops for trailer safety chain

General information

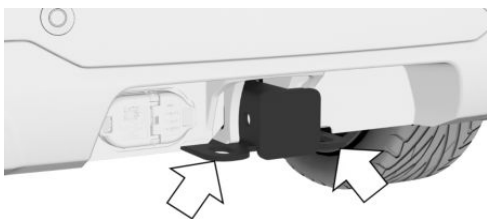

Two eyes can be found on the mount for the trailer hitch for attaching the trailer safety chain.

Safety information

Warning

If the trailer safety line or the trailer safety chain is not fastened correctly, the trailer may unintentionally come loose. There is a risk of accident. Before driving with a trailer, correctly couple the trailer safety line or the trailer safety chain to the eye of the trailer hitch.

Warning

If the trailer safety line or the trailer safety chain is not fastened correctly, the safety line or safety chain may get caught and cause damage to the vehicle or trailer. There is a risk of accident. Before driving with a trailer, correctly couple the trailer safety line or the trailer safety chain to the eye of the trailer hitch. Ensure that the safety line or safety chain can move freely and is not dragging on the ground.

Driving with trailers or rear carriers

Principle

To drive with a trailer or rear carrier, your vehicle must meet certain requirements, e.g., trailer towing is activated. In certain driving situations, you must follow given instructions for correct handling of your trailer or rear carrier, e.g., when driving up-hill or downhill.

When driving with a trailer or rear carrier, some driver assistance systems may be restricted or not available. A Check Control message is displayed where applicable. The driving stability control systems, e.g., Anti-lock Braking System, are still available.

Additional information:

- Driver assistance systems, refer to page 221.
- Driving stability control systems, refer to page 216.

Safety information

Warning

If a trailer hitch is faulty, a trailer cannot be sufficiently secured. There is a risk of accident, injury, and property damage. Do not continue driving with a faulty trailer hitch.

Warning

Depending on the design and loading of trailers, they may begin swinging at speeds exceeding approx. 50 mph/80 km/h. There is a risk of accidents and risk of property damage.

Adapt your speed when driving with a trailer. Immediately brake in the case of swinging. Apply necessary steering corrections as carefully as possible.

Warning

The tire inflation pressure must be adjusted to the increased axle weight in trailer towing. Driving with too low tire inflation pressure can damage the tires. There is a risk of accidents and risk of property damage. Do not exceed a speed of 60 mph/100 km/h. Increase the tire pressure of the towing vehicle by 0.2 bar/3 psi. Note the maximum possible tire inflation pressure indicated on the tire.

Using a trailer or rear carrier

General information

When the trailer power socket is occupied, a drop-down menu appears on the Interaction Unit. The menu can be used to specify whether the vehicle is being driven with a trailer or rear carrier.

Some driver assistance systems may have limited functionality or may malfunction when driving with a trailer or rear carrier, e.g., rear bicycle rack, and an unoccupied trailer power socket. To avoid malfunctions, activate use of the trailer or rear carrier manually.

When the trailer socket is occupied or trailer towing is activated, some driver assistance systems may be restricted or not available. A Check Control message is displayed where applicable.

Safety information

Warning

If the Interaction Unit is configured incorrectly, some driver assistance systems may have limited functionality or malfunction completely. There is a risk of accident. Make sure that the corresponding setting is enabled when using the trailer or rear carrier.

Activating/deactivating trailer towing manually

Trailer towing can be activated or deactivated manually.

1. Go through the menu as follows: Apps menu / "Vehicle" / "Driving settings" / "Driver Assistance" / "Trailer mode" / "Type".
2. Select whether you are driving with or without a trailer/rear carrier.

Maximum speed

The maximum permitted speed for the vehicle-trailer combination can be set when towing a trailer. Depending on vehicle equipment, this setting is considered by speed limit systems.

1. Go through the menu as follows: Apps menu / "Vehicle" / "Driving settings" / "Driver Assistance" / "Trailer mode" / "Max. speed".
2. Select the desired speed.

Additional information:

- Speed Limit Info, refer to page 221.
- Speed Limit Assistant, refer to page 245.

Uphill grades

Permissible gradients

Trailer towing is permitted up to gradients of 12 %.

If higher trailer loads are approved at a later point in time, the permitted gradient limit is 8 %.

Driving off on uphill grades

When driving off on gradients with a vehicle-trailer combination, use the parking brake to prevent the vehicle-trailer combination from rolling backwards.

1.  On the switch cluster, press and release the parking brake button shortly before driving off.
The parking brake is set.
2. Step on the accelerator pedal sufficiently to drive off.
The parking brake is automatically released when the accelerator pedal is activated.

Hills

Vehicle-trailer combinations tend to sway more on hills.

Before going downhill, shift to selector lever position B and drive downhill slowly.

Trailer Assistant

Principle

The Trailer Assistant helps when reversing with a trailer.

With the Trailer Assistant, the steering wheel is not used to steer the vehicle-trailer combination when reversing. The vehicle-trailer combination is steered by continuously entering and correcting the articulation angle on the Interaction Unit or using the buttons for adjusting the exterior mirrors. The articulation angle is the angle between the vehicle and trailer. This angle is thus the desired direction of travel for the vehicle-trailer combination in reverse.

When reversing, the system takes control of steering the front wheels. The driver must control the speed using the accelerator and brake pedals.

Vehicle features and options

This system may not be available in the owned vehicle, e.g. due to the selected optional equipment, the national-market version or the option for later enabling and software updates. This also applies to individual functions of the system.

For information on whether a function is currently available in the vehicle or when the function can be installed in the vehicle, contact an authorized service center or another qualified service center or repair shop.

Additional information:

Vehicle equipment, refer to page 8.

General information

Follow the information in the "Parking assistance systems" chapter.

Additional information:

Parking assistance systems, refer to page 249.

Safety information

Warning

The system cannot serve as a substitute for the driver's personal judgment in assessing the traffic situation. Based on the limits of the system, it cannot independently react to all traffic situations. There is a risk of accident, injury, and property damage. Adjust driving style to traffic conditions. Watch the surrounding traffic situation closely, be ready to take over steering and braking at any time, and actively intervene where appropriate.

Warning

The system can steer the vehicle over or onto curbs. There is a risk of injury and risk of property damage. Watch surrounding traffic closely and actively intervene where appropriate

Functional requirements

The following functional requirements apply for the Trailer Assistant:

- A trailer is attached and connected.
- The system is taught for the trailer to be used.
- Depending on vehicle equipment and national-market version, trailer towing is activated.

- The rearview camera is clean and clear.
- Vehicles with removable trailer hitch: Only use suitable accessories approved by the vehicle manufacturer.

Teaching the Trailer Assistant

Whenever you hitch a trailer, the Trailer Assistant must be taught again.

A message on the Interaction Unit prompts the driver to drive forward at low speed while steering actively.

Turning operating tips on/off

The Trailer Assistant operating tips provide specific information for operating the system properly. The operating tips can be turned on/off.

1. Select a MINI ID or driver profile on the Interaction Unit.
2. Go through the menu as follows: Apps menu / "Vehicle" / "Driving settings" / "Driver Assistance" / "Parking" / "Operating tips for Trailer Assistant".

Reversing with the Trailer Assistant

The Trailer Assistant can be used for reversing with a trailer.

1. Attach and connect a trailer to the vehicle.
2. Teach the Trailer Assistant.
3. Depending on vehicle equipment and national-market version, activate trailer towing on the Interaction Unit.

4.  When your vehicle is stopped, press the Park Assist key on the switch cluster or engage reverse gear. The parking assistance systems view is displayed.

5. On the bottom toolbar, select the following function: "Trailer Assistant".
The rearview camera display appears with a view of the tow bar and a stylized view of the vehicle with trailer.
6. Confirm or turn off operating tips as necessary.
7. If necessary, shift into reverse.
8. Set the desired articulation angle.
Follow the instructions on the Interaction Unit.
9. Take your hands off the steering wheel and carefully drive off using the accelerator pedal and the brake.
 The status symbol for the Trailer Assistant illuminates green. The system takes over the steering.
When driving in reverse, observe the vehicle's surroundings.
In case of obstacles, stop immediately and take over steering.
10. If necessary, adjust the kink angle while driving to correct the direction.
11. Engage selector lever position P when you are finished maneuvering.

Canceling the Trailer Assistant manually

Maneuvering of the car-trailer combination can be aborted manually:

On the bottom toolbar, select the following function: "Cancel".

Canceling the Trailer Assistant automatically

The Trailer Assistant is canceled automatically in situations such as the following:

- When the driver grasps the steering wheel or takes over steering.
- When shifting from reverse gear to selector lever position D, the Trailer Assistant switches to standby mode.
If reverse gear is engaged again after a short distance, the function is active again.
- During activation or intervention by driver assistance systems.
- When overlaying messages on the Interaction Unit display.
- In case of a slippery surface.
- When the vehicle is rolling such as on a slope.
- In case of changed ambient conditions.
- If the vehicle speed exceeds approx. 6 mph/10 km/h.

Activating/deactivating the trailer brake

The trailer brake intervention system helps prevent the vehicle-trailer combination from rolling away in an uncontrolled way. Whenever the Trailer Assistant is canceled, the trailer protection brake is applied and the vehicle is secured at a standstill. The trailer brake can be activated/deactivated on the Interaction Unit.

Go through the menu as follows: Apps menu / "Vehicle" / "Driving settings" / "Driver Assistance" / "Parking" / "Trailer protection braking".

System limits

Speed threshold

The maximum speed is limited to approx. 6 mph/10 km/h.

If the maximum speed is exceeded, the function is interrupted.

A warning is given at a speed of approx. 4 mph/7 km/h.

Functional limitations

The Trailer Assistant may be restricted in the following situations:

- Trailers with fifthwheel steering are not supported.
- Accessories on tow bar, e.g., a rear bicycle rack.
- Tow bars and trailers with unusual shapes.
- Unsuitable removable trailer hitches.
- Rearview camera is dirty or covered.

Additional information:

Cameras, refer to page 40.

Trailer stabilization control

Principle

Trailer stabilization control helps by absorbing the swinging movements of the trailer.

The system detects swinging and automatically brakes the vehicle quickly in order to leave the critical speed range and stabilize the trailer.

General information

If the trailer power socket is occupied but a trailer has not been hitched, the system can also become active in extreme driving situations, e.g., when using a bicycle rack with lighting.

Functional requirement

To use trailer stabilization control, the following functional requirements must be met:

- A trailer is attached.
- The trailer power socket is occupied.
- Vehicle speed must be more than approx. 40 mph/65 km/h.

System limits

The system cannot intervene or not intervene in time in the following situations, for instance:

- If a trailer jackknifes suddenly, for instance on slippery roads or loose surfaces.
- If a trailer with a high center of gravity tilts, before swinging is detected.
- If Dynamic Stability Control is deactivated or has malfunctioned.
- When the power consumption of a trailer is too low, for instance due to tail lights with LED technology, to be detected by the system.

Brake Controller

Trailer brakes only work if a brake controller is installed.

Trailer brakes will not work without the brake controller.

The vehicle manufacturer recommends having the brake controller installed by an authorized service center or another qualified service center or repair shop. Incorrect installation or pinning of the connector can cause the trailer lights and brake system to fail.

For information on installing a brake controller, contact an authorized service center or another qualified service center or repair shop.

Rear carriers

Principle

Rear carriers, e.g., rear bicycle racks, are devices that are mounted on the vehicle in order to help transport cargo.

When driving with a rear carrier, you must follow various specifications, e.g., correct load.

General information

Rear carriers recommended by the manufacturer of the vehicle are available as optional accessories.

Rear bicycle racks for a maximum of three bicycles can be used.

Only use rear carriers that are mounted directly on the mount for the trailer hitch.

Installation

Follow the assembly instructions for the rear carrier when installing.

Loading

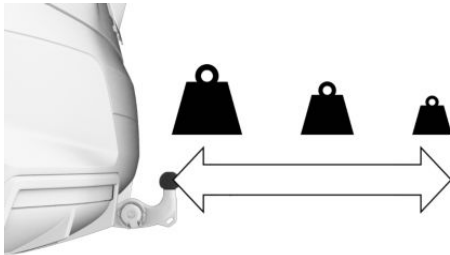

The permissible gross weight of the loaded rear carrier depends on how far its center of gravity is from the ball head.

- If the center of gravity is up to 11.8 inches/30 cm from the ball head, the gross

weight of the rear carrier must not exceed 165 lbs/75 kg.

- If the center of gravity is 23.5 inches/60 cm from the ball head, the gross weight of the rear carrier must not exceed 77 lbs/35 kg.
- Stow heavy cargo as close as possible to the ball head.
- Fasten cargo securely to the rear carrier, making sure it will not slip.

Before driving

Before starting your trip, make sure that the tail lights on the rear carrier are working.

The maximum output of the rear carrier tail lights should not exceed that of the trailer lighting.

Activate trailer towing when necessary to prevent functional limitations and malfunctions of driver assistance systems.

Additional information:

- Electrical consumption, refer to page 319.
- Driving with trailer or rear carrier, refer to page 320.

Driving with a rear carrier

When loaded, rear carriers move the vehicle's center of gravity, which affects how the vehicle handles and steers.

Therefore, note the following when loading and driving:

- Do not exceed the gross axle weight rating and permissible gross vehicle weight.
- Drive cautiously and avoid driving off and braking with jerky movements or fast cornering.

Increasing range

Vehicle features and options

This chapter describes model-specific equipment, systems, and functions that are currently available, or may become available in the future, even if they are not present in the vehicle.

Additional information:

Vehicle equipment, refer to page 8.

Increasing the range

Principle

The vehicle features numerous technologies that reduce energy consumption and maximize range.

There are some actions you can take to increase your range:

- Remove unnecessary cargo from the vehicle.
- Remove add-on parts, e.g., a rear carrier, after use.
- Close the windows and glass sunroof while driving.
- Check the tire pressure regularly and increase it as necessary.
- Use pre-conditioning before driving.
- Anticipatory driving and letting the vehicle coast more often.
- Deactivate functions that are not required, e.g., rear window heating.
- Have the vehicle serviced regularly.

Additional information:

Range, refer to page 153.

Adaptive recuperation

Principle

Adaptive recuperation supports an anticipatory and comfort-oriented driving style.

The system decides based on the situation if and how much the energy is recovered through recuperation or if the vehicle coasts. Depending on the strength of the recuperation, the vehicle is decelerated differently while coasting.

General information

Various sensors analyze the current driving situation, e.g., the distance to the vehicle in front.

Adaptive recuperation is available depending on the equipment and national-market version.

Functional requirements

The system active under the following conditions:

- Selector lever position D is engaged.
- The brake has not been applied.
- The accelerator pedal has not been pressed.
- Dynamic Stability Control is activated.

Activating/deactivating adaptive recuperation

Adaptive recuperation activates when all functional requirements have been met.

Adaptive recuperation can be deactivated and activated manually on the MINI Interaction Unit.

1. To activate/deactivate adaptive recuperation, go through the menu as follows:

Apps menu "All" / "Driving settings" / "Drivetrain and chassis" / "Energy recovery in D".

2. Select the desired setting.

Configuring the recuperation level

The recuperation level can be adjusted.

Additional information:

Driving in detail, refer to page [131](#).

Display

Adaptive recuperation can be displayed on the Interaction Unit.

Additional information:

Power gauge, refer to page [151](#).

System limits

Adaptive recuperation cannot be used, or can only be used to a limited extent, in the following situations:

- When Active Cruise Control is on.
- If driver assistance system sensors are defective, dirty, or covered.

Coasting

Principle

The electric drivetrain makes it possible to roll without consuming energy. This driving condition is referred to as coasting.

General information

An anticipatory driving style helps the driver to coast often and enhances the energy-saving effect of coasting.

Coasting is automatically adapted to the respective driving situation.

Exemplary driving situations

If you can travel a certain distance without any foreseeable need to brake, it is beneficial to coast.

The following example driving situations may be suitable for coasting:

- Coasting on a straight downhill gradient with no obstacles.
- Coasting on a distance without obstacles.

Avoid late or strong braking.

Functional requirements

Note the following functional requirements when coasting:

- Selector lever position D is engaged.
- The brake has not been applied.
- The accelerator pedal has not been pressed.
- Dynamic Stability Control is activated.

System limits

In the following situations, coasting cannot be used at all or only to a limited extent:

- When Active Cruise Control is on.
- If driver assistance system sensors are defective, dirty, or covered.

Green Mode

Principle

Green Mode helps promote an efficient driving style.

In addition, the Efficiency Coach provides instructions, depending on the situation, to ensure an energy-efficient driving style.

Overview

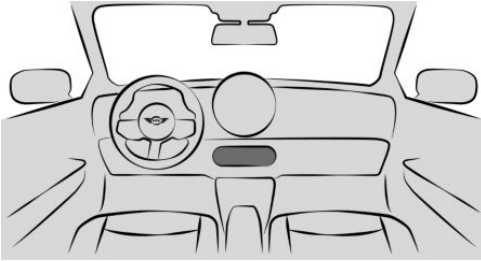

The MINI Modes switch is located on the switch cluster and labeled EXPERIENCE.

Selecting the driving mode





On the switch cluster, select Green Mode using the MINI Modes switch.

Configuring Green Mode



General information

To configure Green Mode, proceed as follows:

-  On the switch cluster, select Green Mode using the MINI Modes switch.
-  Tap the Settings icon on the Interaction Unit.
- Select the desired setting.

Resetting the settings

To reset the settings, proceed as follows:

-  On the switch cluster, select Green Mode using the MINI Modes switch.
-  Tap the Settings icon on the Interaction Unit.
- "Reset settings".

Efficiency trainer

Principle

The Efficiency Coach supports an anticipatory and comfort-oriented driving style. To do so, map and sensor data is used to analyze the current driving situation, e.g., preceding vehicles. Based on this information, the driver receives notices for an efficient driving style early on.

General information

The system has different displays to support the driver with an efficient driving style.

Functional requirements

Note the following functional requirements when using the Efficiency Coach:

- Selector lever position D or B is engaged.
- It may be necessary to activate Experience View in the MINI Modes settings.

Display

General information

When Green Mode is enabled, the view on the Interaction Unit switches to the specific Green Mode view.

In addition, full-screen view and minimal-view contain visualizations for the Efficiency Coach.

Some system information can also be displayed in the Head-up display.



The efficient range of the power gauge is colored green. Additionally, the bonus range will be displayed.

The bonus range and animal symbols for efficient driving styles are displayed, depending on the driving situation.

If the power gauge moves within the green range, the current driving style is efficient. If the driving style is inefficient, the display changes to red and the animal symbol changes.

Additional information:

Power gauge, refer to page 151.

Bonus range

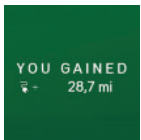

A modified driving style helps you extend your driving range. The extended range is displayed as a bonus range on the Interaction Unit.

The increase/decrease in the bonus range is symbolized by the arrow to the left of the bonus range, providing an indication of the current driving style.

The intervals for resetting the bonus range depend on the settings of the trip data.

Display in case of inefficient driving style



An arrow appears on the Interaction Unit when the vehicle is driven beyond its efficient range.

For instance, this is displayed in the following situations:

- Excessive acceleration.
- Excessive speed.

In addition, information on the reason for the delay can be displayed.

System limits

This function may not be available in the following situations, for example:

- When Active Cruise Control is on.
- With trailer towing.
- When the transmission Sport program is activated.

Max Range

Principle

Depending on the national-market version, the Max Range mode enables the range to be increased through the following measures:

- The maximum speed is limited to 60 mph/90 km/h.
- The drive power will be reduced.
- The comfort functions are restricted, e.g., air conditioning or seat heating are deactivated.

This can increase the maximum range by up to 20 %.

Vehicle features and options

This system may not be available in the owned vehicle, e.g. due to the selected op-

tional equipment, the national-market version or the option for later enabling and software updates. This also applies to individual functions of the system.

For information on whether a function is currently available in the vehicle or when the function can be installed in the vehicle, contact an authorized service center or another qualified service center or repair shop.

Additional information:

Vehicle equipment, refer to page 8.

Functional requirements

To use Max Range mode, the following functional requirements must be met:

- The accelerator pedal is not depressed fully.
- The defrost function is deactivated.

Activating/deactivating Max Range

To activate/deactivate Max Range, proceed as follows:

-  On the switch cluster, select Green Mode using the MINI Modes switch.
- "Max Range".
- "Activate maximum range" or "Deactivate maximum range".
- Configure desired settings as necessary.

System limits

- The achievable additional range depends on the driving style and environmental conditions.
- If visibility is limited, e.g., due to condensation on the windshield, it may be necessary to disable Max Range mode

in order to use the climate control functions.

Charging the vehicle

Vehicle features and options

This chapter describes model-specific equipment, systems, and functions that are currently available, or may become available in the future, even if they are not present in the vehicle.

Additional information:

Vehicle equipment, refer to page 8.

General information

The vehicle can be charged using various charging cables at charging stations, domestic socket outlets or industrial sockets.

Control and monitoring of the charging process are handled fully automatically.

When charging with AC, the charge current can be adjusted using the Interaction Unit.

Safety information

Warning

Working with electrical current improperly can lead to electric shock due to high voltages or high currents. There is a risk of fire, danger to life, and a risk of property damage. Observe the general safety regulations when working with electrical current.

Warning

A faulty or incorrectly designed charging device at the charging location can cause damage to the vehicle and overload the power supply at the charging location. There is a risk of fire, injury, and property damage.

The manufacturer of the vehicle recommends that, prior to your first use of a charging location, you have the compatibility of the following components confirmed:

- Charging cable.
- Charging station.
- Domestic socket outlet and connected circuits.

Warning

Damaged or worn charging equipment, e.g., worn contacts, can become hot. There is a risk of fire, injury, and property damage. Only use chargers that are in good condition.

Warning

Even when it is indicated that the high-voltage battery is discharged, the high-voltage system is always still under high voltage. There is a risk of fire or a risk of injury. Do not touch or change live parts, e.g., orange high-voltage cables, even when the batteries are discharged.

⚠ Warning

Contact with live components can lead to an electric shock. High voltage is present at the charging connection. There is a risk of injury or danger to life.

It is recommended that work on the charging connection, for example cleaning, is performed by an authorized service center or another qualified service center or repair shop.

⚠ NOTICE

The charging cable connected to the vehicle and the charging cable connections may be damaged due to mechanical load. There is a risk of damage to property. Do not apply mechanical loads to the charging cable and the charging cable connections. Route the charging cable to the vehicle freely and avoid stress due to pulling or bending.

Charging the high-voltage battery

The high-voltage battery is an energy storage device. The high-voltage battery can be charged via energy recovery when driving or from the power grid.

Charge the vehicle at a suitable charging device.

Charge the high-voltage battery regularly to ensure that it functions at optimal levels.

When charging via the power grid, you can choose between the following variants:

- Domestic socket outlet.
- Industrial socket.

- AC charging station.
- DC charging station.

To make the best use of electricity from the power grid, we recommended charging at a charging station, e.g., MINI Wallbox.

The power grid and charging station should enable a charging capacity of at least 11 kW.

It will take more time to charge if the charging power is low.

Ensure that the charging station is installed according to the technical requirements of the power grid, e.g. by a qualified electrician.

Charge current

General information

The charge current strength is indicated in amperes.

The maximum permissible charging current varies depending on the respective power grid.

Before charging, set a suitable current limit for the charging current.

When charging at charging stations, the permissible charging current is automatically detected and a current limit is set.

The current limit can be set as needed to charge at a domestic socket outlet.

Safety information

⚠ Warning

If the charge current strength is adjusted incorrectly, the power grid of the domestic socket outlet can be overloaded and overheat. There is a risk of fire, injury, and property damage. Adjust the charge current strength to the power grid prior to charging on domestic socket outlets. With

unknown power networks, set on the lowest level.

Charging on a domestic socket outlet

The permitted charge current strength must be determined, for instance by a qualified electrician, before first charging with your own domestic socket outlet or when charging with third-party domestic socket outlets.

Current limit

General information

The current limit for charging with the Mode 2 charging cable and the Mode 3 charging cable can be set via the Interaction Unit.

When charging at domestic sockets on another power grid, the set charging current again may need to be checked again. The permissible charging current must be determined, e.g., by a qualified electrician, before charging with a domestic socket outlet.

If the approved charging current strength is unknown, set the current limit to the lowest level.

Activating/deactivating current limit

To activate/deactivate the current limit, go through the menu as follows: Apps menu / "Charging" / "AC limit".

Setting the current limit

To set a current limit, go through the menu as follows: Apps menu / "Charging" / "AC limit".

Settings are stored. When the charging location changes, it may be necessary to change the charging settings.

Charging cable

General information

Use a Mode 2 charging cable, Mode 3 charging cable, or the permanently installed charging cable of a charging station to charge the vehicle.

Depending on national-market version, different charging cables are required and are included in the vehicle's scope of delivery.

Safety information

Warning

Incompatible charging cables, adapters, or unsuitable charging stations can heat up, cause damage to the vehicle, or lead to an electric shock. There is a risk of injury, danger to life, and risk of property damage. Use only charging cables, adapters, or charging stations that are recommended for the respective vehicle type.

An authorized service center will be glad to provide information about suitable charging cables and adapters.

Warning

Improper use of the charging cable can prevent charging and lead to damage, for instance cable fire. There is a risk of fire and an injury hazard. Use the charging cable only for charging the vehicle, and do not extend it using cables or adapters.

Warning

Damaged charging cables can become hot or cause electric shock. There is a risk of fire or an injury hazard. Use undamaged charging cables only.

⚠ Warning

An incorrectly connected charging cable can lead to damage, for instance cable fire. There is a risk of injury and risk of damage to property. Make sure that the charging cable connector is completely inserted in the charging socket.

AC charging cable

Mode 2 charging cable

Mode 2 charging cables can be used to charge the vehicle from grounded domestic socket outlets. Charging at domestic socket outlet electrical connections is performed with alternating current.

When a Mode 2 charging cable is used, the efficiency values may differ from those stated on the energy label.

The Mode 2 charging cable is also referred to as standard charging cable.

Flexible Fast Charger, Mode 2

The Flexible Fast Charger is a special mode 2 charging cable.

The interchangeable mains plugs of the Flexible Fast Charger allow you to charge flexibly using domestic socket outlets or industrial sockets with protective conductors.

Mode 3 charging cable

The Mode 3 charging cable makes it possible to quickly recharge at sockets of designated AC charging stations using a special connector. Charging is performed with alternating current at designated AC charging stations. The charging process can be completed faster than at domestic socket outlets.

Depending on vehicle equipment and national-market version, a maximum charge current level of 16 A to 32 A is possible.

The charging cable may be permanently installed at the charging station.

The Mode 3 charging cable is also referred to as AC quick charging cable.

DC charging cable

DC charging stations provide the DC charging cable. The vehicle is charged with direct current at the designated DC charging stations. When using the DC charging station's power outlet with the higher rating, the charging time is normally significantly lower than when using a domestic socket outlet or AC charging station.

When charging at a DC charging station, a notice will appear on the Interaction Unit.

Charge the vehicle only with a DC charging cable with a length of less than 98 ft/30 m.

The DC charging cable is also referred to as Mode 4 charging cable.

Storage

For the outbound delivery, the charging cable is stowed in the cargo area, for instance under the cargo area floor or in a bag.

After using the charging cable, stow it in the same place.

If the charging cable is stowed in a bag, attach the bag to an open lashing eye in the cargo area.

Roll up the charging cable loosely and make sure that it is not damaged when stowed, e.g., cable becomes bent.

To prevent moisture from accumulating on the charging cable connector, store the charging cable with the attached connector cover as necessary.

Connecting the charging cable

General information

Before connecting, if necessary clean the charging cable plug and the area between

the charging socket flap and charging socket, e.g., remove snow.

Functional requirements

To connect the charging cable, the following functional requirements must be met:

- The selector lever position P is engaged.
- Drive-ready state is switched off.
- The vehicle is unlocked.
- The parking brake is set.

Charging socket flap



The charging socket flap is located in the rear on the right side of the vehicle.

Keep charging socket clean and unobstructed.

If the charging socket is not being used, open the charging socket flap and, if necessary, keep the charging socket lid closed.

Connecting the charging cable

To charge, connect the charging cable to the domestic socket outlet or to the AC charging station and to the vehicle.

When charging at a charging station, follow the instructions on the charging station.

1. To open the charging socket flap, press on the rear edge, arrow.

The charging socket flap opens.



2. Open the desired charging socket cover.
3. If necessary, remove the cover of the charging cable connector.
4. Connect the Mode 2 charging cable to the domestic socket outlet, or connect the Mode 3 charging cable to the AC charging station socket as needed.
5. Insert the charging cable connector into the charging socket and push it in until it engages.
6. Hold the charging cable until it locks correctly.

Removing the charging cable

General information

AC charging: The charging cable is locked when charging while the vehicle is locked. Unlock the vehicle before removing.

Direct current charging: during the charging process, the charging cable is locked. The charging cable releases when the charging process is complete.

Before disconnecting, clean the area between the charging socket flap and charging socket as necessary, e.g., remove snow.

Removing the charging cable

To stop the charging process, disconnect the charging cable from the vehicle and

then from the domestic socket outlet or AC charging station.

1. Release the charging cable using the charging cable release button on the charging socket or via the Interaction Unit.

AC charging: Charging stops when the vehicle is unlocked.

DC charging: Charging stops when the charging cable is released via the Interaction Unit or the charging station directly.

2. Press the release button on the handle, arrow 1, and grasp the charging cable on the gripping areas.

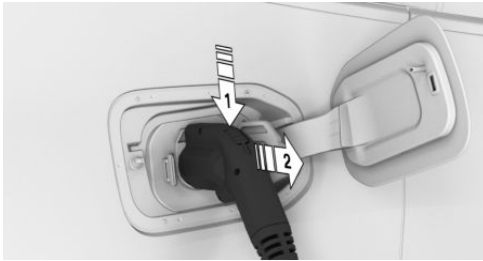

3. Disconnect the charging cable from the charging socket, arrow 2.
4. Close the charging socket cover until it engages.
5. Press the charging socket flap closed until it engages.
6. If necessary, attach the charging cable connector cover.
7. Disconnect the Mode 2 charging cable from the domestic socket outlet, or disconnect the Mode 3 charging cable from the AC charging station socket as needed.
8. If necessary, stow the charging cable. Plug in the charging cable provided at the charging station at the designated location.

Unlocking the charging cable

Principle

Depending on charging socket, when the vehicle is unlocked, the charging cable can be released using the charging cable release button on the charging socket.

DC charging cable: The charging cable is released by, e.g., using the Interaction Unit or stopping the charging process at the charging station.

In addition, all charging cables can be released via the Interaction Unit.

Releasing the charging cable using the key



The charging cable release key is located next to the charging socket.

Releasing the charging cable via the Interaction Unit



"Unlock cable": To release the charging cable, tap the icon on the charging screen.

Additional settings for unlocking

The Interaction Unit can be used to adjust additional settings for unlocking.

1. Go through the menu as follows: Apps menu / "Charging" / "Settings".
2. Select the desired setting:

- "Unlock AC charging cable at end of charging": The AC charging cables unlock automatically as soon as the charging process is finished.
- "Unlock charging socket flap permanently": The charging socket flap can be kept unlocked so that it can be opened even when the vehicle is locked.

Charging process

Principle

The charging process can be adapted to given constraints, e.g., electricity costs, available power sources, or low ambient temperature. The vehicle controls the charging process in such a way that the charging process is completed if possible at the departure time. A departure time must be set for this purpose.

General information

High/low outside temperatures can cause charging to take longer.

When charging the vehicle, a charge target can be set, thereby shortening the charging duration.

Charging may stop if the Mode 2 charging cable is exposed to high temperatures and direct sunlight. The charging process will continue automatically.

A charging procedure is canceled or not started due to the installation of a Remote Software Upgrade. The charging procedure may not continue automatically after the successful installation.

Safety information

NOTICE

The charging socket flap and charging socket cover may be damaged by strain. There is a risk of property damage. Do not strain the charging socket flap and charging socket cover, e.g., by dropping the charging cable.

Plug & Charge

Principle

With Plug & Charge, data from multiple charging contracts with different charging providers can be saved to the vehicle. At compatible charging stations, the vehicle automatically sends saved data to the charging station. This makes it easier to charge at public charging stations that are settled by charging contract. Once the charging cable is connected, charging can begin immediately.

General information

A contract with a charging service provider is usually required for public charging stations. To log in at the charging station, enter your contract information into the charging station, e.g., by using a charging card. With Plug & Charge, there is no need to manually log in at the charging station any more.

For more information on Plug & Charge, see the My MINI App.

Functional requirements

Contract information is sent to the charging station under the following conditions:

- The charging contract must contain Plug & Charge and include the respective vehicle.
- The charging station must support Plug & Charge.
- Plug & Charge must be activated in the vehicle.

Saving contract information to the vehicle

To save contract information to the vehicle, proceed as follows:

1. Go through the menu as follows: Apps menu / "Charging" / "Settings" / "Plug & Charge".
2. Select the desired setting.

Saved charging contracts are listed.

Activating/deactivating Plug & Charge

To activate/deactivate Plug & Charge, proceed as follows:

1. Go through the menu as follows: Apps menu / "Charging" / "Settings" / "Plug & Charge".
2. Select the desired setting.

Using Plug & Charge

1. Before connecting the charging cable, make sure that Plug & Charge is activated in the vehicle and that the desired charging contract is selected.
2. Connect the charging cable.

Charging can be started immediately or will begin automatically. Follow any instructions given at the charging station.

Preparing the high-voltage battery

Principle

Charging at the optimal high-voltage battery temperature increases the charging power and decreases the charging time.

The battery heat management system prepares the high-voltage battery for charging at DC charging stations. The high-voltage battery temperature is adjusted during this process.

General information

Various factors, e.g., the remaining range, are taken into account for preheating/precooling.

Battery thermal management can reduce range and increase energy consumption.

Automatic activation

The best possible way to preheat/precool the high-voltage battery upon reaching a given destination is to start route guidance to a DC charging station.

1. Go through the menu as follows: Apps menu / "Charging" / "Settings" / "Precondition battery" / "Automatic".
2. Select the desired setting.

Additional information:

Destination input, see Owner's Manual for Navigation, Entertainment, Communication;

Activating/deactivating manually

The high-voltage battery preheating/precooling can be activated and deactivated manually.

1. Go through the menu as follows: Apps menu / "Charging" / "Settings" / "Precondition battery".
2. Select the desired setting.

The availability of this function is affected by certain factors. Manual activation is not possible in the following situations, for example:

- The remaining range is too low.
- The high-voltage battery's charge is too high.
- Automatic preparation of the high-voltage battery is on.
- The vehicle is charging.
- Max Range mode is on.

A time display indicates how long it will take for the high-voltage battery to reach the target temperature. Depending on current energy requirements, the time shown may differ from the actual time.

At low outside temperatures, preheating the high-voltage battery can take considerably longer.

Depending on vehicle equipment, the system can also be operated with the MINI app on a smartphone.

Additional information:

Max Range, refer to page 330.

Status display

The control display can show information on the temperature of the high-voltage battery and whether it is ready for DC charging.

Go through the menu as follows: Apps menu / "Vehicle" / "Vehicle status" / "Battery temperature".

Additional information:

Vehicle status, refer to page 156.

Starting the charging process

The charging process can be started when the vehicle is stationary.

1. Engage selector lever position P. Apply the parking brake, if necessary.
2. Set the charging mode or schedule charging.
Scheduling charging, see Charging time windows, refer to page 341.
3. Switch off drive-ready state.
4. Connect the Mode 2 charging cable to the domestic socket outlet, or connect the Mode 3 charging cable to the AC charging station socket as needed.
5. Connect the charging cable to the vehicle.
Connecting the charging cable, refer to page 335.
6. Lock vehicle if it is unlocked.

Once the charging cable connector is plugged into the high-voltage charging socket, the charging cable is locked automatically.

Charging status display

Indicator light on the charging socket

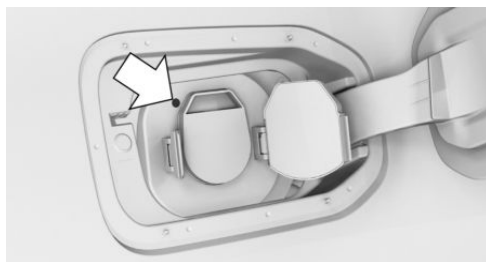

The charging status is indicated on the indicator light on the charging socket.

Charging status

Light	Meaning
White	The charging cable can be connected.
Orange	The charging cable is locked.
Flashing orange	The charging process is being prepared.
Yellow	The charging process is paused.
Flashing yellow	The charging process is active.
Flashing red	Fault in the charging process.
Green	The charging process is complete.

When the vehicle is locked, the indicator light goes out after some time.

When the vehicle is unlocked, the yellow indicator light flashes continuously. The other indicator lights turn off after some time.



To check the charge level, press the button on the vehicle key. The charge level is shown by the indicator light. In some cases the vehicle is locked.

Additional messages about the charge level can be shown on the Interaction Unit or on the mobile device via the MINI app.

Setting the charging mode

There are a number of charging mode settings you can change.

1. Go through the menu as follows: Apps menu / "Charging" / "Charging mode".
2. Select the desired settings:

- "Immediately": the charging process starts as soon as the charging cable is connected.
- "Time slot": If a departure time is set, a time frame for charging can be set, e.g., to charge using a cheap electricity rate.

Charging time windows

General information

A time frame can be set for the charging process, e.g., to charge with a cheap electricity rate.

The vehicle can also start the charging process before the selected time frame begins or end it after the selected time frame finishes. The start time for charging is adjusted so that, by the departure time, the vehicle battery is charged as much as possible and the climate control can run as necessary.

Functional requirement

A departure time must be specified to charge during a time window.

Setting a time frame for charging

Charging can be done within a desired time window.

1. Go through the menu as follows: Apps menu / "Charging" / "Charging mode" / "Time slot".
2. Select the desired setting.

Charge target

Principle

The high-voltage battery can be set to charge to specific target values in percent.

Charging takes less time when low charging targets are used.

General information

A target value of 80 % is recommended for fast charging and optimal service life of the high-voltage battery.

Target values below 20 % cannot be set.

Set charge target

The charging target can be set by percentage.

1. Go through the menu as follows: Apps menu / "Charging" / "Charge up to".
2. Set the round segment display on the Interaction Unit to the desired value.

Permissible volume of DC charging

The noise emitted when charging at DC charging stations can be limited, e.g., to comply with local regulations on volume. Charging may take more time if there are noise restrictions.

1. Go through the menu as follows: Apps menu / "Charging" / "Settings" / "Fan loudness".
2. Select the desired setting.

Stopping the charging process

The charging process can be stopped at any time by removing the charging cable and continued at a later time by connecting the charging cable. For example, so that other people can use the electrical connection in the meantime, or in order to avoid excessive strain on the electrical connection.

Additional information:

Detach, refer to page 336.

Continuing the charging process

If the charging process is interrupted, e.g., due to a temporary power failure, it continues automatically once the interruption is over.

When the vehicle is charged at a public charging station, the charging process may not continue automatically after an interruption.

Ending the charging process

To stop the charging process, proceed as follows:

1. Disconnect the charging cable from the vehicle.
Detach, refer to page 336.
2. If necessary, stow the charging cable.
3. Press the charging socket flap closed until it engages.
4. Lock vehicle if it is unlocked.

Goodbye screen on the Interaction Unit











When drive-ready state is turned off, the Interaction Unit displays a menu that can be used, for example, to configure some charging settings via the Interaction Unit.



Display

If standby state is on, the charge state indicator on the Interaction Unit shows the high-voltage battery's charge.

Information regarding the charging process is shown on the charging screen.

Display	Meaning
AC	Charging the vehicle with a Mode 2 charging cable or Mode 3 charging cable.
DC	Charging the vehicle with a DC charging cable.

Display	Meaning
	Current charging capacity. + Icon indicates that the vehicle has reached its maximum charging power.
	Maximum charging current or current limit set.
	Charging cable locked.
	Release the charging cable.
	A charging target has been set.
	A departure time has been set.
	A one-time departure time has been set.
	Air conditioning is activated for the departure time.
	Flashing: Pre-conditioning is turned on.
	Blue icon: Reduced charging power due to low temperature of high-voltage battery.
	White icon: Reduced charging power due to high temperature of high-voltage battery.

Display	Meaning
	The temperature of the high-voltage battery is adjusted for an upcoming charging process. Preparing the high-voltage battery, refer to page 339
	The charging capacity of the charging station may be restricted or not available.

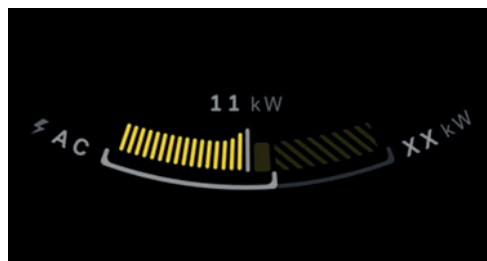

The shaded area indicates a limitation in the charging capacity that can occur, for instance due to the connected charging infrastructure.

Additional information:

- Charge state indicator, refer to page 155
- Charging screen, refer to page 156.

Departure time

Principle

For optimum range and air conditioning, the departure time can be set before parking the vehicle.

General information

To precondition the vehicle for the set departure time, configure the air conditioning system.

The following settings are possible for departure time:

- Running air conditioning for a departure time.
- Scheduling up to three regular departure times.
- Scheduling a one-time departure time.

Air conditioning for departure time

To configure the air conditioning for a specific departure time, go through the menu as follows: Apps menu / "Charging" / "Departure plan" / "Pre-conditioning for departure".

Setting the departure time

Departure times can be set.

1. Go through the menu as follows: Apps menu / "Charging" / "Departure plan".
2. Select the desired departure time.
3. Set the time and day of the week.

Activating the departure time

A set departure time can be activated.

1. Go through the menu as follows: Apps menu / "Charging" / "Departure plan".
2. Activate the desired departure time.

The set departure time will be deactivated if the departure time was ignored three times in a row.

Climate control

The following settings for vehicle air conditioning can be configured:

- Activate pre-conditioning immediately.
The range will be reduced if pre-conditioning is activated without a charging cable connected.
- Planned air conditioning at the set departure time.

Additional information:

Pre-conditioning, refer to page [291](#).

Location-based charging settings

Principle

Various settings can be selected for charging at charging stations.

To simplify recharging at known charging locations, some changed settings such as charging mode can be saved based on location.

General information

When the location-based charging settings function is on, some settings are saved automatically as soon as charging is complete and the charging cable is disconnected.

These settings are saved with the GPS coordinates of the charging location.

Saved settings are enabled as soon as the vehicle approaches a known charging location again.

Before charging, ensure that the settings enabled match the desired charging station, e.g., charging mode.

When the vehicle leaves a known charging location, the settings are automatically set to factory settings.

Functional requirement

To use the location-based charging settings, your vehicle must be able to receive GPS signals.

Activate/deactivate the function

To enable/disable location-based charging settings, go through the menu as follows: Apps menu / "Charging" / "Settings" /

"Location-based charging settings" / "Save based on location".

If this function is disabled, no location-based settings are saved and saved settings are not enabled.

Depending on vehicle equipment, the system can also be operated with the MINI app on a smartphone.

Interaction Unit view

The Location-based Charging Settings menu provides a list of the charging settings associated with this function.

Saving active charging settings for other charging locations

The charging settings currently set in the menu can be saved as default settings for other charging locations.

To save charging settings, go through the menu as follows: Apps menu / "Charging" / "Settings" / "Location-based charging settings" / "Apply current settings for new locations".

Deleting location-based charging settings

To delete location-based charging settings, go through the menu as follows: Apps menu / "Charging" / "Settings" / "Location-based charging settings" / "Delete all location-based charging settings".

Discharged high-voltage and vehicle battery

To operate its on-board electronics, the vehicle has a 12V battery in addition to its high-voltage battery.

With a discharged vehicle battery, no operation of the vehicle is possible.

Service life of high-voltage battery

General information

The performance of the high-voltage battery, and thus the vehicle's range, decreases over its service life. When used correctly, an optimal service life of the high-voltage battery can be achieved.

Charging instructions

Charging habits have a significant effect on the high-voltage battery's service life:

- If the vehicle is stationary for long periods of time with a battery charge of over 80 %, this may negatively affect the battery's usable energy, charging time, and charging power during DC charging.
- Frequent DC charging with a charging power greater than 100 kW may negatively affect the battery's usable energy, charging time, and charging power during DC charging.
- If the vehicle has been charged several times in a row with DC, this system may temporarily reduce the charging power to protect the high-voltage battery. If reduced, the charging power is reset after a few hours. DC charging again can extend this time.

Optimization of high-voltage battery service life

When used correctly, an optimal service life of the high-voltage battery can be achieved.

- Charge high-voltage batteries with low charging power using an AC charging station or Wallbox.
- For daily use, operate the vehicle with a charge level between 10 % and 80 %. A charging target of 80 % can be set for this.

Charge target, refer to page [341](#).

- Recharge the high-voltage battery as close to a planned departure as possible. A time frame can be set for charging. Charging time windows, refer to page [341](#).
- Reduce the load on the high-voltage battery by using an efficient, anticipatory driving style. Increasing the range, refer to page [327](#).
- Avoid direct sunlight at high outside temperatures.

Long stationary periods, vehicle shutdown

If planning to leave the vehicle stationary for long periods of time, note the following:

- If the vehicle is to be stationary for more than 6 months, park the vehicle with a battery charge between 50 % and 80 %. Check the battery charge every 6 months.
- If the vehicle is stationary for less than 6 months, park the vehicle with a charge level between 30 % and 50 %.
- Do not park the vehicle for longer than 14 days if the electric range is depleted.
- Do not leave the charging cable connected.

Maintenance

The high-voltage battery is maintenance-free.

End of high-voltage battery service life

If unrestricted driving can no longer be ensured because the high-voltage battery is exhibiting very advanced aging, Check Control messages appear to indicate power and range restrictions.

The vehicle must be inspected by an authorized service center or another qualified service center or repair shop. If, in this case, no inspection is performed, it may no longer be possible to put the vehicle into operation.



A system error appears before it becomes impossible to put the vehicle into operation.

It is not necessary to interrupt the current trip, which can be ended as planned.

However, it will no longer be possible to continue driving the next time the vehicle is started.

Additional information:

- Check Control, refer to page [144](#).
- Indicator lights and warning lights, refer to page [145](#).

Wheels and tires

Vehicle features and options

This chapter describes model-specific equipment, systems, and functions that are currently available, or may become available in the future, even if they are not present in the vehicle.

Additional information:

Vehicle equipment, refer to page 8.

Tire pressure

General information

The tire condition and tire pressure influence the following:

- Tire service life.
- Driving safety.
- Driving comfort.
- Electrical consumption.

Safety information

Warning

A tire with too little or no tire inflation pressure may heat up significantly and sustain damage. This will have a negative impact on aspects of handling such as steering and braking response. There is a risk of accident, injury, and property damage. Regularly check the tire inflation pressure, and correct it as needed, for instance twice a month and before a long trip.

Tire pressure specifications

In the tire pressure table

The tire pressure table contains all tire inflation pressure specifications for given tire sizes at ambient temperature. The tire inflation pressure specifications apply to the tire sizes approved by the vehicle manufacturer for the corresponding vehicle types.

To identify the correct tire inflation pressure, please note the following:

- Tire sizes of the vehicle.
- Maximum speed for driving.

On the Interaction Unit

Current tire pressures and nominal tire pressures for fitted tires can be displayed on the Interaction Unit.

To ensure that they are displayed correctly, the tire sizes must be stored in the system and must have been set for the mounted tires.

The current tire inflation pressure value is located on each tire.

The reference tire pressure is shown at the bottom of the Interaction Unit.

Checking the tire pressure

General information

The tires heat up while driving. The tire pressure increases with the tire temperature.

Check the tire pressure regularly and correct as necessary.

Tires have a natural, consistent tire pressure loss. The displays of inflation devices may under-read by up to 0.1 bar/2 psi.



Functional requirements

Only check the tire pressure when the tires are cold, i.e.:

- A distance traveled of max. 1.25 miles/2 km has not been exceeded.
- If the vehicle has not moved again for at least two hours after a trip.

Checking via tire pressure specifications in tire pressure table

To check the tire pressure using the tire pressure specifications in the tire pressure table, proceed as follows:

1. Determine the nominal tire pressure for your tires using the information on the door pillar in the driver's door.
2. Check the tire inflation pressure in all four tires, using a pressure gage, for example.
3. Correct the tire inflation pressure if the actual tire inflation pressure deviates from the intended tire inflation pressure.
4. Make sure that all valve caps are screwed onto the tire valves.

The tire pressures specified in the tire pressure table only correspond to cold tires or tires at ambient temperature.

If vehicle is equipped with an emergency wheel: Check the tire pressure of the emergency wheel in the cargo area regularly and correct as necessary.

Tire inflation pressures up to 100 mph/160 km/h

For speeds of up to 100 mph/160 km/h and for optimum driving comfort, follow the tire inflation pressure specifications in the tire pressure table and adjust as necessary.

Checking tire pressure specifications on Interaction Unit

To check the tire pressure using the tire pressure information on the Interaction Unit, proceed as follows:

1. Go through the menu as follows: Apps menu / "Vehicle" / "Vehicle status" / "Tire Pressure Monitor".
2. Check whether the current tire inflation pressure levels deviate from the intended tire pressure value.
3. Correct the tire inflation pressure if the actual tire inflation pressure deviates from the intended tire inflation pressure.

The Interaction Unit may not be able to display current tire pressures when the vehicle is stationary. The tire pressure will update after a short drive.

After correcting the tire pressure

If your vehicle is equipped with a Tire Pressure Monitor, the corrected tire pressures are applied automatically. Make sure that the tire settings are correct. When using tires not listed in the tire inflation pressure specifications on the Interaction Unit, reset the Tire Pressure Monitor.

If your vehicle is equipped with the Flat Tire Monitor, reinitialize it.



Do not exceed a speed of 100 mph/160 km/h.

The tire inflation pressure specifications can also be found on the tire pressure label on the driver's door pillar.

Tire pressure values up to 100 mph/160 km/h

SE ALL4

The tire inflation pressure specifications in the tire pressure table correspond to cold tires and full load.

Tire size	Front wheel Tire pressure specifications in bar/PSI	Rear wheel Tire pressure specifications in bar/PSI
225/55 R 18 102 H XL A/S	2.5 / 36	3.0 / 44
245/45 R 19 102 H XL A/S		
225/55 R 18 102 Y XL		
245/45 R 19 102 Y XL		
225/55 R 18 102 H XL M+S		
245/45 R 19 102 H XL M+S		

Tire pressures over 100 mph/160 km/h

Warning

When driving at speeds greater than 100 mph/160 km/h, incorrect tire pressures can negatively affect vehicle handling, e.g., safety or comfort while driving. The tires can become damaged, which

may cause an accident. There is a risk of accident, injury, and property damage. To drive at maximum speeds, note the specified tire pressure for driving above 100 mph/160 km/h in the tire inflation pressure table, and adjust as necessary.

Tire pressure values over 100 mph/160 km/h

SE ALL4

The tire inflation pressure specifications in the tire pressure table correspond to cold tires and full load.

Tire size	Front wheel Tire pressure specifications in bar/PSI	Rear wheel Tire pressure specifications in bar/PSI
225/55 R 18 102 H XL A/S	2.7 / 39	3.3 / 48
245/45 R 19 102 H XL A/S		
225/55 R 18 102 Y XL		
245/45 R 19 102 Y XL		
225/55 R 18 102 H XL M+S		
245/45 R 19 102 H XL M+S		

Tire marking

Tire size

245/45 R 18 96 Y

245: nominal width in mm

45: cross-sectional relationship in %

R: radial tire code

18: rim diameter in inches

96: load index

Y: speed code letter

ZR tires: reinforced radial tire for speeds exceeding 150 mph/240 km/h

Maximum tire load

Maximum tire load is the maximum permissible weight for which the tire is approved.

Locate the maximum tire load on the tire sidewall and the Gross Axle Weight Rating – GAWR – on the certification label on the driver door B-pillar. Divide the tire load by 1.1. It must be greater than one-half of the vehicle's Gross Axle Weight Rating – GAWR. Note, front vs. rear GAWR and tire loads, respectively.

Speed letter

Designation	Maximum speed
Q	up to 100 mph/160 km/h
R	up to 106 mph/170 km/h
S	up to 112 mph/180 km/h
T	up to 118 mph/190 km/h
H	up to 131 mph/210 km/h
V	up to 150 mph/240 km/h
W	up to 167 mph/270 km/h
Y	up to 186 mph/300 km/h
(Y)	above 186 mph/300 km/h

Tire Identification Number

DOT code: DOT xxxx xxx 1924

xxxx: manufacturer code for the tire brand

xxx: tire size and tire design

1924: tire age

Tires with DOT codes meet the guidelines of the U.S. Department of Transportation.

Tire age

Recommendation

Regardless of the tire tread depth, replace tires at least every 6 years.

Production date

You can find the tire production date on the tire sidewall.

Designation	Production date
DOT ... 1924	19th week of 2024

Uniform Tire Quality Grading

Quality grades can be found where applicable on the tire sidewall between tread shoulder and maximum section width.

E.g.: Treadwear 200; Traction AA; Temperature A

DOT Quality Grades

Treadwear

Traction AA A B C

Temperature A B C

All passenger vehicle tires must conform to Federal Safety Requirements in addition to these grades.

Treadwear

The treadwear grade is a comparative rating based on the wear rate of the tire when tested under controlled conditions on a specified government test course. E.g., a tire graded 150 would wear one and one-half, 1 g, times as well on the government course as a tire graded 100. The relative performance of tires depends upon the actual conditions of their use, however, and may depart significantly from the norm due to variations in driving habits, service practices and differences in road characteristics and climate.

Traction

The traction grades, from highest to lowest, are AA, A, B, and C.

Those grades represent the tire's ability to stop on wet pavement as measured under controlled conditions on specified government test surfaces of asphalt and concrete. A tire marked C may have poor traction performance.

The traction grade assigned to this tire is based on straight-ahead braking traction tests, and does not include acceleration, cornering, hydroplaning, or peak traction characteristics.

Temperature

The temperature grades are A, the highest, B, and C, representing the tire's resistance to the generation of heat and its ability to dissipate heat when tested under controlled conditions on a specified indoor laboratory test wheel. Sustained high temperature can cause the material of the tire to degenerate and reduce tire life, and excessive temperature can lead to sudden tire failure. The grade C corresponds to a level of performance which all passenger car tires must meet under the Federal Motor Vehicle Safety Standard No. 109. Grades Band A represent higher levels of performance on the laboratory test wheel than the minimum required by law.

Warning

The temperature grade for this tire is established for a tire that is properly inflated and not overloaded. Excessive speed, underinflation, or excessive loading, either separately or in combination, can cause heat buildup and possible tire failure. There is a risk of accident, injury, and property damage.

M+S

Winter tires, as well as all-season tires with better winter performance than summer tires, can be identified by the M+S marking on the tire side wall.

Tire tread depth

Safety information

Warning

If the tire tread depth is too low, driving safety may be impaired in critical situations such as aquaplaning or slush on the road. There is a risk of accident, injury, and property damage. The tire tread depth may not fall below 0.12 in/3 mm for summer tires and 0.16 in/4 mm for winter and all-season tires, or observe the statutory regulations on minimum tread depth.

Minimum tread depth

You can check the minimum tread depth on your tires using the wear indicators.

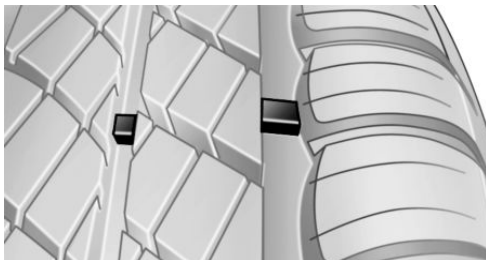

The tire manufacturer's wear indicators are distributed over the tire circumference. These indicators have a height of min. 0.06 in/1.6 mm and serve as an indicator for tire tread wear.

The positions of the wear indicators are marked on the tire sidewall with TWI, Tread Wear Indicator.

Tire damage

General information

Check your tires regularly for damage, foreign objects lodged in the tread, and tread wear.

The following abnormalities may indicate tire damage or a malfunction on the vehicle:

- Unusual vibrations.
- Unusual tire or running noises.
- Unusual vehicle handling such as a strong tendency to pull to the left or right.
- Uneven wear pattern, e.g., increased wear near tire shoulder.

Tire damage can be caused by situations such as the following:

- Driving over curbs.
- Road damage.
- Tire pressure too low.
- Vehicle overloading.
- Incorrect tire storage.

Safety information

Warning

Damaged tires can lose tire inflation pressure, which can lead to loss of vehicle control. There is a risk of accident, injury, and property damage. If tire damage is suspected while driving, immediately reduce speed and stop. Have wheels and tires checked. To do so, drive carefully to an authorized service center or another qualified service center or repair shop. Have the vehicle towed or transported as

needed. Do not repair damaged tires, but have them replaced.

Warning

The wheels, tires and chassis components can become damaged when driving over curbs, road damage, or other obstacles. Larger wheels have a smaller tire cross-section. The smaller the tire cross-section, the higher the risk of tire damage. There is a risk of accident, injury, and property damage. If possible, avoid driving over curbs, road damage or other obstacles, or drive over them slowly and carefully.

Exchanging wheels and tires

Mounting and wheel balancing

Have the wheel mounted and balanced by an authorized service center or another qualified service center or repair shop.

Suitable wheels and tires

General information

Only certain wheel/tire combinations are suitable depending on vehicle and equipment. The vehicle manufacturer determines wheel/tire combinations on the basis of the following criteria:

- Tire size, e.g., tire width, aspect ratio.
- Wheel size, e.g., rim diameter, offset.

For more information on wheel/tire combinations and special equipment, contact an authorized service center or another qualified service center or repair shop.

Safety information

Warning

Wheels and tires that are not suitable for the vehicle can damage parts of the vehicle. There is a risk of accident, injury, and property damage. The vehicle manufacturer recommends that you use only wheels and tires that have been recommended for the vehicle type.

Warning

Wheel/tire combinations that are not suitable for the vehicle can affect vehicle handling and a number of system functions, e.g., the Antilock Braking System or Dynamic Stability Control. There is a risk of accident, injury, and property damage. The manufacturer of the vehicle recommends that you use wheels and tires that have been recommended by the vehicle manufacturer for the vehicle type. Following tire damage, have the original wheel/tire combination remounted on the vehicle as soon as possible.

Recommended tire brands



Tire types are developed for each vehicle and optimized specifically for the individual requirements of that vehicle, e.g.:

- Handling.
- Comfort.
- Noise characteristics.

Specially developed tires are marked with a star on the tire sidewall. After replacing wheels and tires, the vehicle manufacturer recommends using star-marked tires again. The vehicle manufacturer recommends that you use tires of the same make and tread design.

New tires

Tire traction is not optimal due to manufacturing circumstances when tires are brand new.

Drive conservatively for the first 200 miles/300 km.

Retreaded tires

Warning

Retreaded tires can have different tire casing structures. With advanced age the service life can be limited. There is a risk of accident, injury, and property damage. The manufacturer of the vehicle does not recommend the use of retreaded tires.

Maximum speed

Safety information

Warning

If the maximum permissible speed of your mounted tires is exceeded, the tires may be damaged. There is a risk of accident, injury, and property damage. Do not exceed the maximum permissible speed of the tires.

Maximum speed of winter tires

If the maximum speed of the vehicle is higher than the permissible speed of the winter tires, the maximum permissible speed must be indicated with a sign placed in the field of vision. The info label is available from an authorized service center or another qualified service center or repair shop.

Winter tires



Winter tires are recommended for operating on winter roads.

Winter tires can be identified by the mountain/snowflake icon and the letters M+S on the tire sidewall.

So-called all-season tires with the M+S designation but no mountain/snowflake icon perform better in winter than summer tires. As a rule, all-season tires do not perform the same as winter tires.

Wheel change between axles

Different tread wear patterns can occur on the front and rear axles depending on individual driving conditions. The tires can be rotated in pairs between the axles to achieve even abrasion. For more information, contact an authorized service center or another qualified service center or repair shop. After changing a wheel, check the tire pressure and correct as necessary.

Storing tires

Do not exceed the maximum tire pressure specified on the tire sidewall, also when storing tires.

When storing tires, note the following:

- Store wheels and tires in a cool, dry and dark place.
- Protect tires from coming into contact with oil, grease, and solvents.
- Do not leave the tires in plastic bags.
- Remove dirt from wheels or tires.

Repairing a flat tire

If you get a flat tire, take the following safety precautions:

- Park the vehicle on solid and non-slip ground at a safe distance from road traffic.
- Switch on the hazard warning lights.
- Engage the parking brake.
- Turn the steering wheel until the front wheels are in the straight-ahead position and engage the steering wheel lock.
- As soon as permitted by the traffic flow, have all vehicle occupants get out and make sure that they remain outside the hazardous area such as behind a guard-rail.
- If necessary, set up the hazard triangle or hazard warning lights at a suitable distance.

Repair the flat tire, e.g., using a tire repair set or by changing the wheel.

Tire repair set

Principle

The tire repair set is used to temporarily seal minor tire damage so that it is possible to continue driving.

The filled in tire sealant closes the damage from the inside when it hardens.

The compressor can be used to check the tire inflation pressure.

The tire repair set may be insufficient if the tire damage measures more than approx. 0.16 in/4 mm.

General information

- Follow the instructions for using the tire repair set, which are provided on the compressor and sealant bottle.
- Do not remove foreign objects that have penetrated the tire. Remove foreign objects only when they are visibly protruding from the tire.

Overview

Storage

Depending on vehicle equipment, the tire repair set is stored as follows:

- In the cargo area under the cargo area floor.
- In the cargo area on the left or right side.
- In the cargo area behind a side trim panel.

Sealant bottle and filler hose

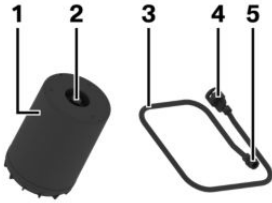

- 1 Sealant bottle
- 2 Sealant bottle outlet
- 3 Filler hose
- 4 Sealant bottle connection
- 5 Wheel valve connection

- Engage the parking brake.
- Turn the steering wheel until the front wheels are in the straight-ahead position and engage the steering wheel lock.
- As soon as permitted by the traffic flow, have all vehicle occupants get out and make sure that they remain outside the hazardous area such as behind a guard-rail.
- If necessary, set up the hazard triangle or hazard warning lights at a suitable distance.
- Remove the warning label for the maximum permissible speed from the sealant bottle and attach it in the visible area in the vehicle interior.

Compressor

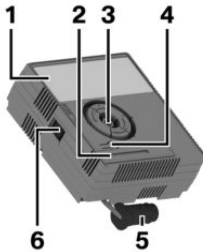

- 1 Compressor
- 2 Tire pressure display
- 3 Sealant bottle mount
- 4 Pressure reducing valve button
- 5 Connector for socket
- 6 Power switch

Preparing the tire repair set

1. To prepare the tire repair set, place the sealant bottle into the holder on the compressor housing.



2. Turn the sealant bottle clockwise by 90° to the stop.

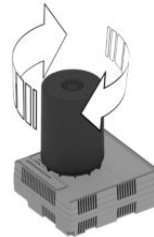

Safety precautions

When using the tire repair set, take the following safety precautions:

- Park the vehicle as far away as possible from passing traffic and on solid ground.
- Switch on the hazard warning lights.

3. Connect the filler hose to the outlet of the sealant bottle and turn clockwise by 90° to the stop.



4. Unscrew the valve cap from the wheel and screw the connecting piece of the filler hose onto the valve.

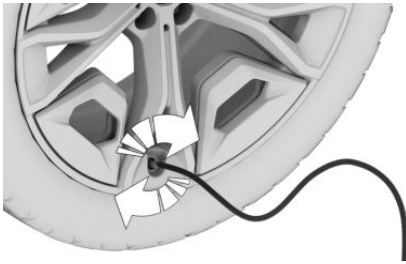

5. With the compressor switched off, insert the connector into the power socket in the vehicle interior.

Filling the tire with sealing compound

Safety information

NOTICE

The compressor can overheat during extended operation. There is a risk of property damage. Do not run the compressor for more than 10 minutes.

Filling the tire with sealing compound

To fill in tire sealant, let the compressor run for max. 10 minutes until a tire pressure of 2.5 bar/36 psi is reached.

1. With standby state or drive-ready state switched on, switch on the compressor. When adding sealant, the Tire Pressure Monitor may briefly rise up to approx. 6 bar/87 psi before it shows the actual tire pressure again. Do not turn off the compressor at this stage.
2. Switch off the compressor when you reach a tire pressure of 2.5 bar/36 psi.

Checking the tire pressure

To check the tire pressure, read the tire pressure gauge on the compressor. The tire pressure must be at least 2.5 bar/36 psi.

Tire pressure too high

If the tire pressure is too high, reduce the tire pressure with the pressure reducing valve on the compressor.

Minimum tire pressure not reached

Do not continue driving unless a minimum tire pressure of 2.5 bar/36 psi is reached. Contact an authorized service center or another qualified service center or repair shop.

Minimum tire pressure reached

When the tire pressure is at least 2.5 bar/36 psi, proceed as follows:

1. Pull the connector out of the socket in the vehicle interior.
2. Disconnect the hose from the sealant bottle and from the valve on the wheel.
3. Screw the valve cap onto the valve.

4. Stow the tire repair set in the cargo area.
5. Immediately drive 6 miles/10 km to ensure that the tire sealant is evenly distributed in the tire.

Do not exceed the speed limit of 50 mph/80 km/h.

If possible, do not drive at speeds less than 12 mph/20 km/h.

Tire sealant may spray from the damaged area when you rotate the wheel initially.

Adjusting the tire pressure

To adjust the tire pressure after using the tire repair set, proceed as follows:

1. Stop at a suitable location.
2. Connect the hose directly to the compressor and turn clockwise by 90° until it audibly engages.
3. Unscrew the valve cap on the wheel and screw the connecting piece of the hose onto the valve.

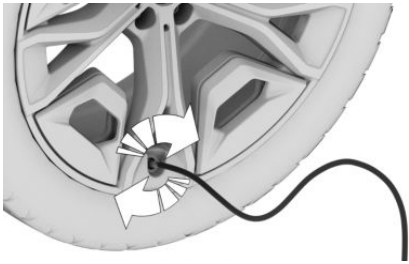

4. Insert the connector into the socket in the vehicle interior.
 5. Read the tire pressure on the tire pressure display of the compressor.
- Do not continue driving unless a minimum tire pressure of 1.3 bar/19 psi is displayed. Contact an authorized service

center or another qualified service center or repair shop.

6. Correct the tire pressure to 2.5 bar/36 psi.
 - To increase the tire pressure when standby or drive-ready state is on: Turn on the compressor and let it run for max. 10 minutes.
 - To decrease the tire pressure: Press the pressure reducing valve button on the compressor.

Removing and stowing the tire repair set

To remove and stow the tire repair set, proceed as follows:

1. Switch off the compressor.
2. Pull the connector out of the socket in the vehicle interior.
3. Disconnect the hose from the compressor and the valve on the wheel.
4. Screw the valve cap onto the valve.
5. Stow the tire repair set together with the hose in the cargo area.

Continuing the trip

Continue driving immediately once finished with the tire repair set.

Re-initialize the Flat Tire Monitor or reset the Tire Pressure Monitor.

Do not exceed the speed limit of 50 mph/80 km/h.

Do not exceed the maximum travel distance of 125 miles/200 km.

Replace the faulty tire and the sealant bottle from the tire repair set as soon as possible.

Additional information:

- Flat tire monitor, refer to page [366](#).
- Tire pressure monitor, refer to page [359](#).

System limits

If the tire cannot be made drivable, contact an authorized service center or another qualified service center or repair shop.

If vehicle is equipped with Tire Pressure Monitor, note: Using tire sealant can damage the tire pressure sensor. In this case, have the air pressure sensor replaced at the next opportunity.

Snow chains

General information

Certain wheels and tires are recommended by the manufacturer of the vehicle for operation on the vehicle. Mounting of snow chains on these wheels and tires is not permitted.

Safety information

Warning

Mounting snow chains on unsuitable tires can cause the snow chains to come into contact with vehicle parts. There is a risk of accidents and risk of property damage. Do not mount snow chains.

Tire pressure monitor

Principle

The Tire Pressure Monitor monitors the tire pressure and issues a warning if the tire pressure has dropped.

The sensors in the tire valves measure the tire pressure and tire temperature.

Depending on the tires detected or entered, the system displays the specified nominal

pressures on the Interaction Unit and compares these with the current tire pressures.

General information

When using tires not found in the tire inflation pressure specifications on the vehicle, e.g., tires with special approval, the Tire Pressure Monitor must be actively reset. The system will then take over the actual tire inflation pressures as the target pressures.

When operating the system, also note the information found in the Tire inflation pressure chapter.

Additional information:

Tire inflation pressure, refer to page [347](#).

Safety information

Warning

The display of the target pressures is not a substitute for the tire inflation pressure details on the vehicle. Incorrect entries in the tire settings can lead to incorrect target tire inflation pressure values. In this case, it cannot be guaranteed that the notification of a tire pressure loss will be reliable. There is a risk of injury and risk of property damage. Make sure that the sizes of your mounted tires are displayed correctly and match the information on the tires and the tire inflation pressure specifications on the vehicle.

Functional requirements

If the following requirements are not met for the Tire Pressure Monitor, tire pressure losses may not be reported reliably:

- Whenever a tire or wheel is changed, this system detects and updates the mounted tires, displaying them on the



Interaction Unit after driving for a short time.

Enter the information about the mounted tires in the tire settings when the system does not automatically detect the tires.

- The Tire Pressure Monitor does not activate until after driving for a few minutes:
 - After a tire or wheel change.
 - After a reset, when using tires with special approval.
 - After changing tire settings.
- When using tires with special approval, note the following:
 - After a tire or wheel change, a reset was performed with the correct tire inflation pressure.
 - After the tire inflation pressure was adjusted to a new value, a reset was performed.
- Wheels with tire pressure sensors are mounted.

Tire settings

General information

You can enter information on your mounted tires in the tire settings if the tires are not automatically detected by the system.

The tire sizes of the mounted tires can be gathered from the tire inflation pressure details on the vehicle or directly on the tires.

The tire details do not need to be re-entered when the tire pressure is corrected.

For summer and winter tires, the tire details entered last are stored. After a tire or wheel change, the settings of the tire sets used last can be selected.

Configuring the tire settings

To enter information on equipped tires in the tire settings, proceed as follows:

1. Go through the menu as follows:
Apps menu / "Vehicle" / "Vehicle status" / "Tire Pressure Monitor" / "Tire settings" / "Tire selection" / "Manual" / "Tire type".
2. Select the tire size for the rear axle.
When using tires with special approval:
"Other tires"
Follow the instructions given in the "Performing a reset" section.
3. Select the maximum speed to be driven.
4. "Save tire settings"

The measurement of the current tire inflation pressure is started. The measurement progress is displayed.

Status display

Current status

The status of the Tire Pressure Monitor, e.g., whether this system is active, can be shown on the Interaction Unit.

Go through the menu as follows: Apps menu / "Vehicle" / "Vehicle status" / "Tire Pressure Monitor".

The current status is displayed.

Current tire pressure

The current tire pressure is displayed for each tire.

The current tire inflation pressures may change while driving or depending on the outside temperature.

Nominal pressure

The nominal pressure for the tires on the front and rear axles is displayed.

The specified nominal pressures take the influence of driving and outside temperature on the tire temperature into account. The appropriate nominal pressure is always displayed, independent of the weather situation, tire temperatures and travel times.

The displayed nominal pressure may change and may differ from the tire inflation pressure details on the door pillar of the driver's door. The tire inflation pressure can thus be corrected to the value of the displayed target pressures.

The nominal pressure is immediately adjusted if the vehicle load state is changed in the tire settings.

Tire conditions

General information

The tire condition and system status are indicated by the wheel color and text on the Tire Pressure Monitor on the Interaction Unit.

Any existing messages may not be deleted if the nominal pressure is not reached after the tire inflation pressure is corrected.

All wheels green

On the Interaction Unit, each wheel illuminates green in the Tire Pressure Monitor when the system is active.

- This system bases any warnings on target pressures.
- When using tires with special approval, this system bases any warnings on the last tire pressures saved at the reset.

One to four yellow wheels

In the Tire Pressure Monitor on the Interaction Unit, one to four wheels illuminate if one of the tires shown is flat or has lost a large amount of pressure.

Gray wheels

The wheels illuminate gray on the Interaction Unit if it is not possible to detect a loss of tire pressure.

Possible causes are:

- The system may not be operational.
- After confirming the tire settings, the tire pressure is measured automatically.
- When using tires with special approval: The system is being reset.

For tires with special approval: performing a reset

When using tires with special approval, proceed as follows to reset:

1. Go through the menu as follows: Apps menu / "Vehicle" / "Vehicle status" / "Tire Pressure Monitor".
2. Make sure that the tire settings are correct.
3. Turn on drive-ready state but do not drive off.
4. "Perform reset"
5. Drive off.

The wheels are shown in gray and the tire pressure is reset.

After a travel time of several minutes, the set tire inflation pressures are accepted as the predefined tire inflation pressures. The reset is completed automatically while driving.

After resetting, the wheels are shown in green on the Interaction Unit and a message appears.

You may interrupt this trip at any time. When you continue driving the reset resumes automatically.

Additional information:

Tire settings, refer to page 360.

Messages: for tires without special approval

General information

When using tires without special approval, the Tire Pressure Monitor may display a message.

When a flat tire is indicated, the Dynamic Stability Control may be turned on.

Safety information

Warning

A damaged regular tire with low or no tire inflation pressure impacts handling such as steering and braking response. There is a risk of accident, injury, and property damage. Do not continue driving. Repair the flat tire or replace the wheel.

If a tire inflation pressure check is required

Message

When using tires without special approval, the Tire Pressure Monitor displays a message if it is necessary for you to check the tire pressure.

An icon with a Check Control message appears on the Interaction Unit.

Icon	Possible cause
	Leak detected on the tire. Inflation was not carried out according to specifications, for instance when the tire has not been sufficiently inflated or in the case of a natural steady tire pressure loss.

Measure

Check the tire pressure and correct as needed.

If the tire inflation pressure is too low

Message

When using tires without special approval, the Tire Pressure Monitor displays a message if the tire pressure is too low.



A yellow warning light illuminates on the Interaction Unit.

In addition, an icon with a Check Control message appears on the Interaction Unit.

Icon	Possible cause
	There is a tire pressure loss.

Measure

1. Reduce the vehicle speed. Do not continue to exceed a speed of 80 mph/130 km/h.
2. At the next opportunity, for instance at a filling station, check the tire inflation pressure in all four tires and correct if necessary.

If there is a significant tire pressure loss

Message

When using tires without special approval, the Tire Pressure Monitor displays a message if a tire loses a significant amount of pressure.



A yellow warning light illuminates on the Interaction Unit.

In addition, an icon with the corresponding tire appears in a Check Control message on the Interaction Unit.

Icon	Possible cause
	There is a flat tire or a major tire pressure loss.

Measure

1. Reduce your speed and come to a stop carefully. Avoid sudden braking and steering maneuvers.
2. Follow the instructions for what to do in case of a flat tire.

Messages: for tires with special approval

General information

When using tires with special approval, the Tire Pressure Monitor may display a message.

When a flat tire is indicated, the Dynamic Stability Control may be turned on.

Safety information

Warning

A damaged regular tire with low or no tire inflation pressure impacts handling such as steering and braking response. There is a risk of accident, injury, and property damage. Do not continue driving. Repair the flat tire or replace the wheel.

If a tire inflation pressure check is required

Message

When using tires with special approval, the Tire Pressure Monitor displays a message if it is necessary for you to check the tire pressure.

An icon with a Check Control message appears on the Interaction Unit.

Icon	Possible cause
	<p>Inflation was not carried out according to specifications, e.g., the tire has not been sufficiently inflated.</p> <p>The system has detected a wheel change, but no reset was done.</p> <p>The tire inflation pressure has fallen below the level of the last reset.</p> <p>No reset was performed for the system. The system issues a warning based on the tire inflation pressures stored during the last reset.</p>

Measure

1. Check the tire pressure and correct as needed.
2. Perform a system reset.

If the tire inflation pressure is too low

Message

When using tires with special approval, the Tire Pressure Monitor displays a message if the tire pressure is too low.



A yellow warning light illuminates on the Interaction Unit.

In addition, an icon with a Check Control message appears on the Interaction Unit.

Icon	Possible cause
	<p>There is a tire pressure loss.</p> <p>No reset was performed for the system. The system issues a warning based on the tire inflation pressures stored during the last reset.</p>

Measure

1. Reduce the vehicle speed. Do not continue to exceed a speed of 80 mph/130 km/h.
2. At the next opportunity, for instance at a filling station, check the tire inflation pressure in all four tires and correct if necessary.
3. Perform a system reset.

If there is a significant tire pressure loss

Message

When using tires with special approval, the Tire Pressure Monitor displays a message if a tire loses a significant amount of pressure.



A yellow warning light illuminates on the Interaction Unit.

In addition, an icon with the corresponding tire appears in a Check Control message on the Interaction Unit.

Icon	Possible cause
	<p>There is a flat tire or a major tire pressure loss.</p> <p>No reset was performed for the system. The system issues a warning based on the tire inflation pressures stored during the last reset.</p>

Measure

1. Reduce your speed and come to a stop carefully. Avoid sudden braking and steering maneuvers.
2. Follow the instructions for what to do in case of a flat tire.

Actions in the event of a flat tire

1. In the event of a flat tire, identify the damaged tire.
2. Check the tire pressure in all four tires, for instance using the tire pressure display of a flat tire kit.

For tires with special approval: when the tire pressure in all four tires is correct, the Tire Pressure Monitor may not have been reset. Then perform the reset.

If no tire damage can be identified, contact an authorized service center or another qualified service center or repair shop.

3. Repair the flat tire, e.g., using a tire repair set or by changing the wheel.

The use of sealant, e.g., from the tire repair set, may damage the wheel electronics. Have the electronics replaced at the next opportunity.

System limits

Temperature

The tire inflation pressure depends on the tire's temperature.

Driving or exposure to the sun will increase the tire temperature, thus increasing the tire inflation pressure.

The tire inflation pressure is reduced when the tire temperature falls again.

These circumstances may cause a warning when temperatures fall very sharply.

Following a temperature-related warning, the nominal pressures are shown on the In-

teraction Unit again after driving for a short time.

Sudden tire pressure loss

The system is not able to indicate sudden and serious tire damage and the resulting loss of tire pressure caused by external circumstances.

Failure performing a reset

When using tires with special approval, the system will not function correctly if it has not been reset. For example, a flat tire may be indicated although the tire pressures are correct.

Malfuction

Message

The Tire Pressure Monitor displays a message if the system is not operational.



The yellow warning light flashes and is then illuminated continuously. A Check Control message is displayed.

It may not be possible to identify tire pressure losses.

Measure

If the Tire Pressure Monitor system is not operational, proceed as follows:

- If a wheel without air pressure sensor is mounted, have the wheels checked as necessary.
- Fault due to systems or devices with same transmission frequency: The system reactivates automatically upon leaving the interference zone.
- The system was unable to completely reset when using tires with special approval. Perform a system reset again.
- If the Tire Pressure Monitor has failed: Have the vehicle checked by an author-

ized service center or another qualified service center or repair shop.

Declaration according to NHTSA/ FMVSS 138 Tire Pressure Monitoring System

Each tire, including the spare (if provided) should be checked monthly when cold and inflated to the inflation pressure recommended by the vehicle manufacturer on the vehicle placard or tire inflation pressure label. (If the vehicle has tires of a different size than the size indicated on the vehicle placard or tire inflation pressure label, you should determine the proper tire inflation pressure for those tires.) As an added safety feature, the vehicle has been equipped with a tire pressure monitoring system (TPMS) that illuminates a low tire pressure telltale when one or more of your tires is significantly under-inflated. Accordingly, when the low tire pressure telltale illuminates, you should stop and check your tires as soon as possible, and inflate them to the proper pressure. Driving on a significantly under-inflated tire causes the tire to over-heat and can lead to tire failure. Under-inflation also reduces fuel efficiency and tire tread life, and may affect the vehicle's handling and stopping ability. Please note that the TPMS is not a substitute for proper tire maintenance, and it is the driver's responsibility to maintain correct tire pressure, even if under-inflation has not reached the level to trigger illumination of the TPMS low tire pressure telltale. The vehicle has also been equipped with a TPMS malfunction indicator to indicate when the system is not operating properly. The TPMS malfunction indicator is combined with the low tire pressure telltale. When the system detects a malfunction, the telltale will flash for approximately one minute and then remain continuously illuminated. This sequence will continue upon subsequent vehicle start-ups as long as the malfunction exists. When the mal-

function indicator is illuminated, the system may not be able to detect or signal low tire pressure as intended. TPMS malfunctions may occur for a variety of reasons, including the installation of replacement or alternate tires or wheels on the vehicle that prevent the TPMS from functioning properly. Always check the TPMS malfunction telltale after replacing one or more tires or wheels on the vehicle to ensure that the replacement or alternate tires and wheels allow the TPMS to continue to function properly.

Flat tire monitor

Principle

The flat tire monitor detects a tire pressure loss while driving and issues a warning if the tire pressure has dropped.

The system does not measure the actual inflation pressure in the tires.

The system detects tire pressure loss on the basis of rotation speed differences between the individual wheels while driving.

If a tire loses pressure, the diameter and thus the rotational speed of the corresponding wheel changes. The difference will be detected and reported as a flat tire.

Functional requirements

If the following requirements are not met for the Flat Tire Monitor, a loss in tire pressure may not be reliably reported:

- After a tire or wheel change, an initialization was carried out at the correct tire pressure.
- After the tire pressure was adjusted to a new value, an initialization was performed.

Status display

The current status of the Flat Tire Monitor can be displayed on the Interaction Unit, e.g., to check whether the Flat Tire Monitor is active.

Go through the menu as follows: Apps menu / "Vehicle" / "Vehicle status" / "Flat Tire Monitor".

The status is displayed.

Initialization required

The Flat Tire Monitor must be initialized in the following situations:

- After the tire inflation pressure has been adjusted.
- After a tire or wheel change.

Performing initialization

When initializing, the set tire inflation pressures serve as reference values in order to detect a flat tire. Initialization is started by confirming the tire inflation pressures.

Do not initialize the system when driving with snow chains.

To initialize the Flat Tire Monitor, proceed as follows:

1. Go through the menu as follows: Apps menu / "Vehicle" / "Vehicle status" / "Flat Tire Monitor".
2. Turn on drive-ready state but do not drive off.
3. "Perform reset".
4. Drive off.

The initialization is completed while driving, which can be interrupted at any time.

The initialization automatically continues when driving continues.

Messages

General information

The Tire Pressure Monitor displays a message when a tire is flat.

When a flat tire is indicated, the Dynamic Stability Control (DSC) is turned on, if needed.

Safety information

Warning

A damaged regular tire with low or no tire inflation pressure impacts handling such as steering and braking response. There is a risk of accident, injury, and property damage. Do not continue driving. Repair the flat tire or replace the wheel.

Indication of a flat tire

The Flat Tire Monitor displays a message when a tire is flat.



A yellow warning light illuminates on the Interaction Unit.

In addition, an icon with a Check Control message appears on the Interaction Unit.

Icon	Possible cause
	There is a flat tire or a major tire pressure loss.

Measure

1. Reduce your speed and come to a stop carefully. Avoid sudden braking and steering maneuvers.
2. Follow the instructions for what to do in case of a flat tire.

Actions in the event of a flat tire

1. In the event of a flat tire, identify the damaged tire.
2. To do this, check the tire pressure in all four tires, for instance using the tire pressure display of a flat tire kit.
When the tire inflation pressure in all four tires is correct, the flat tire monitor may not have been initialized. Then initialize the system.
If tire damage cannot be identified, contact an authorized service center or another qualified service center or repair shop.
3. Repair the flat tire, e.g., using a tire repair set or by changing the wheel.

System limits

The Flat Tire Monitor may react with a delay or malfunction in the following situations:

- A natural, even tire pressure loss in all four tires will not be recognized. Therefore, check the tire inflation pressure regularly.
- Sudden and serious tire damage caused by external circumstances cannot be recognized in advance.
- The system has not been initialized.
- When driving on a snow-covered or slippery road.
- For sporty driving, e.g., due to slippage on the drive wheels or high lateral acceleration.
- When driving with snow chains.

Changing wheels/tires

General information

When a flat tire kit is used, an immediate wheel change when there is a tire pressure loss in the event of a breakdown is not always necessary.

If necessary, a suitable wheel change tool, e.g., a jack, is available as an accessory from an authorized service center or another qualified service center or repair shop.

Safety information

Warning

The jack is only provided for short-term lifting of the vehicle for wheel changes. Even if all safety precautions are observed, there is a risk of the raised vehicle falling if the jack tips over. There is a risk of injury or danger to life. When the vehicle is raised with the jack, do not lie under the vehicle and do not switch on the drive-ready state.

Warning

Placing supports, e.g., wooden blocks or similar, under the jack may reduce its ability to bear weight because of the limited height. The load-carrying capacity of the wooden blocks may be exceeded and the vehicle may tip over. There is a risk of injury or danger to life. Do not place supports under the jack.

Warning

The jack, issued by the vehicle manufacturer, is provided in order to perform a wheel change in the event of a breakdown. The jack is not designed for frequent use, e.g., changing from summer to winter

tires. Using the jack frequently may cause it to become jammed or damaged. There is a risk of injury and risk of property damage. Only use the jack to change an emergency or spare wheel in the event of a breakdown.

Warning

The jack may slip on soft, uneven, or slippery ground, e.g., snow, ice, tiles, etc. There is a risk of injury. If possible, change the wheel on a flat, solid, slip-resistant surface.

Warning

The jack is optimized for lifting the vehicle and for the jacking points on the vehicle only. There is a risk of injury. Do not lift any other vehicle or cargo using the jack.

Warning

When the jack is not inserted into the jacking point provided for this purpose, the vehicle may be damaged or the jack may slip when it is being cranked up. There is a risk of injury and risk of property damage. When cranking up the jack, ensure that it is inserted in the jacking point next to the wheel well.

Warning

A vehicle that is raised on a jack may fall off of the jack if lateral forces are exerted on it. There is a risk of injury and risk of property damage. While the vehicle is raised, do not exert lateral effort on the vehicle or pull abruptly on the vehicle. Have a stuck wheel removed by an authorized

service center or another qualified service center or repair shop.

Warning

Incorrect handling of the jack can damage the vehicle's underbody and expose high-voltage components. There is a risk of injury and risk of property damage. When cranking up the jack, ensure that it is inserted in the jacking point next to the wheel well. Make sure not to damage any of the underbody parts.

NOTICE

Using an impact wrench to loosen or tighten the wheel lock bolt can damage the wheel lock bolt. There is a risk of property damage. Only use a lug wrench to loosen and tighten the wheel lock bolt.

Securing the vehicle against rolling away

General information

The vehicle manufacturer recommends to additionally secure the vehicle against rolling away when changing a wheel.

On a level surface



Place chocks or other suitable objects in front and behind the wheel that is diagonal to the wheel being changed.

On a slight downhill gradient



If it is necessary to change a wheel on a slight downhill gradient, place chocks and other suitable objects, e.g., rocks, under the wheels of the front and rear axles, against the direction that the vehicle will move.

Lug bolt lock

Principle

The wheel bolt lock offers effective protection against wheel theft.

The wheel lug bolts have a special coding. The lug bolts can only be released with the adapter which matches the coding.

Overview

The lug bolt lock adapter is stored in a bag on the cargo area floor.

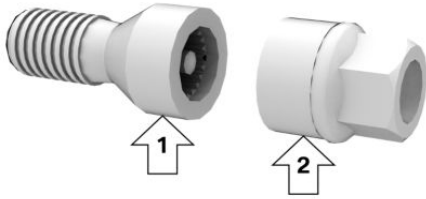

- Lug lock bolt, arrow 1.
- Adapter, arrow 2.

Unscrewing

1. To unscrew, place the adapter on the wheel lock bolt.
2. Unscrew the lug lock bolt.
3. Remove the adapter after unscrewing the lug bolt.

Screwing on

1. To screw on, place the adapter on the wheel lock bolt. Turn the adapter until it fits onto the wheel lock bolt.
2. Screw on the wheel lock bolt. The tightening torque is 101 lbs ft/140 Nm.
3. After screwing on, remove the adapter again.

Safety precautions

Take the following safety measures when changing a wheel:

- Park the vehicle on solid and non-slip ground at a safe distance from road traffic.
- Switch on the hazard warning lights.
- Engage the parking brake.
- Turn the steering wheel until the front wheels are in the straight-ahead position and engage the steering wheel lock.
- Engage a gear or selector lever position P.

- As soon as permitted by the traffic flow, have all vehicle occupants get out and make sure that they remain outside the hazardous area such as behind a guard-rail.
- If necessary, set up the hazard triangle or hazard warning lights at a suitable distance.
- Depending on vehicle equipment, remove the wheel change set and, if necessary, the emergency wheel from the vehicle.
- Secure the vehicle so that it does not roll away.
- Loosen the lug bolts a half turn.

Jacking points

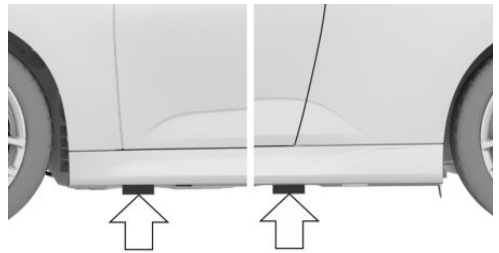

The jacking points are located at the indicated positions.

Jacking up the vehicle

Warning

Hands and fingers can be jammed when using the jack. There is a risk of injury. Comply with the described hand position and do not change this position while using the jack.

To raise the vehicle so that you can change a wheel, proceed as follows:

1. Hold the vehicle jack with one hand, arrow 1, and grasp the jack crank handle or lever with your other hand, arrow 2.

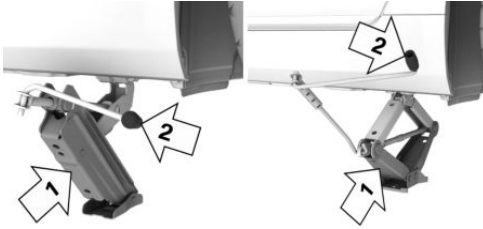

2. Insert the jack into the rectangular recess of the jacking point closest to the wheel to be changed.

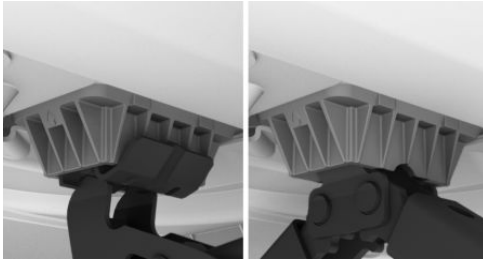

3. Extend the jack by turning the jack crank handle or lever clockwise.



4. Take your hand away from the jack as soon as the jack is under load and continue turning the jack crank handle or lever with one hand.

5. Make sure that the car jack foot extends vertically and is at a right angle beneath the jacking point.

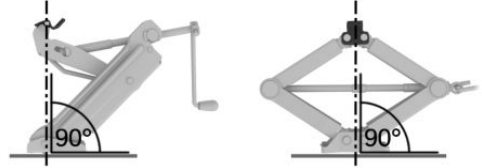

6. Crank the vehicle up until the vehicle jack has the entire surface on the ground and the relevant wheel is maximum 1.2 inches/3 cm above ground.

Mounting a wheel

Mount one emergency wheel only, as required.

To change a wheel, proceed as follows:

1. Unscrew the lug bolts.
2. Remove the wheel.
3. Put the new wheel or emergency wheel on and screw in at least two lug bolts in a crosswise pattern until hand-tight.

When non-original light-alloy wheels of the vehicle manufacturer are mounted, the accompanying lug bolts may have to be used as well.

4. Hand-tighten the remaining lug bolts and tighten all lug bolts well in a crosswise pattern.
5. Turn the jack crank handle counter-clockwise to retract the jack and lower the vehicle.
6. Remove the jack and stow it securely.



After the wheel change

After changing the wheel, do the following:

1. Tighten the lug bolts crosswise. The tightening torque is 101 lbs ft/140 Nm.
2. Stow the faulty wheel in the cargo area, if necessary.
3. Check the tire pressure at the next opportunity and correct as necessary.
4. Re-initialize the Flat Tire Monitor or re-set the Tire Pressure Monitor.
5. Check to make sure the lug bolts are tight with a calibrated torque wrench.
6. Drive to the nearest authorized service center or another qualified service center or repair shop, then have the damaged tire replaced.

Under the hood

Vehicle features and options

This chapter describes model-specific equipment, systems, and functions that are currently available, or may become available in the future, even if they are not present in the vehicle.

Additional information:

Vehicle equipment, refer to page 8.

Safety information

Warning

Improperly executed work under the hood can damage components and lead to a safety hazard. There is a risk of accident, injury, and property damage. The vehicle manufacturer recommends having work under the hood performed by an authorized service center or another qualified service center or repair shop.

Overview



1 Filler neck for washer fluid

2 Coolant reservoir

Hood

Safety information

Warning

An incorrectly locked hood can open while driving and restrict visibility. There is a risk of accident, injury, and property damage. Stop immediately and correctly close the hood.

Warning

Body parts can be jammed when opening and closing the hood. There is a risk of injury. Make sure that the area of movement of hood is clear while opening and closing.

Warning

Improperly executed work under the hood can damage components and lead to a safety hazard. There is a risk of accident, injury, and property damage. The vehicle manufacturer recommends having work under the hood performed by an authorized service center or another qualified service center or repair shop.

Warning

There are protruding parts, for instance locking hooks, on the inside of the hood. There is a risk of injury. If the hood is open, pay attention to protruding parts and keep clear of these areas.

Warning

There are moving components under the hood. Certain components under the hood can also move with the vehicle switched off, for instance the radiator fan. There is a risk of injury. Do not reach into the area of moving parts. Keep articles of clothing and hair away from moving parts.

NOTICE

Folded-out wipers can be jammed when the hood is opened. There is a risk of property damage. Make sure that the wipers with the wiper blades mounted are folded down onto the windshield before opening the hood.

NOTICE

When the hood is closed, it must engage on both sides. Pressing again can damage the hood. There is a risk of property damage. Open the hood again and then close it energetically. Avoid pressing again.

Opening hood

1. In the footwell, pull the lever to open the hood, arrow 1.

Hood is unlocked.



2. Release the lever and pull it again, arrow 2.

Hood can be opened.

3. Be careful of protruding parts on the hood.

Closing the hood

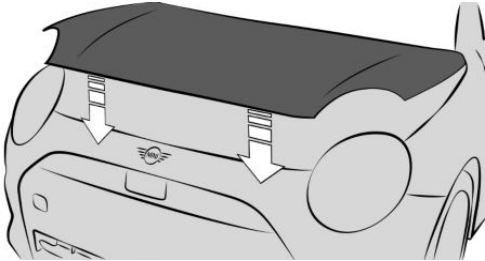

Energetically close the hood from approx. 20 in/50 cm.

The hood must engage on both sides.

Operating fluids

Vehicle features and options

This chapter describes model-specific equipment, systems, and functions that are currently available, or may become available in the future, even if they are not present in the vehicle.

Additional information:

Vehicle equipment, refer to page 8.

Coolant

General information

The cooling system is maintenance-free.

Have coolant topped up by an authorized service center or another qualified service center or repair shop.

Coolant level

A Check Control message appears on the Interaction Unit when the coolant level is low.

Washer fluid

Principle

Washer fluid is used to clean the windshields and sensors. All spray nozzles are supplied from one tank.

Use a mixture of tap water and windshield washer concentrate. If desired, a windshield washer concentrate containing antifreeze can be used.

Recommended minimum fill quantity:
0.4 US gal/2 liters.

Safety information

Warning

Some types of antifreeze can contain harmful substances and are flammable. There is a risk of fire and an injury hazard. Follow the instructions on the containers. Keep antifreeze away from ignition sources. Do not fill operating fluids into different bottles. Store operating fluids out of reach of children.

United States: the washer fluid mixture ratio is regulated by the U.S. EPA and many individual states; do not exceed the allowable washer fluid dilution ratio limits that apply. Follow the usage instructions on the washer fluid container.

Use of BMW's Windshield Washer Concentrate or the equivalent is recommended.

NOTICE

Silicon-containing additives in the washer fluid for the water-repelling effect on the windows can lead to damage to the car wash. There is a risk of property damage. Do not add silicon-containing additives to the washer fluid.

NOTICE

Mixing different windshield washer fluid concentrates or antifreeze can damage the washer system. There is a risk of property damage. Do not mix different windshield washer fluid concentrates or antifreeze. Follow the information and mixture ratios provided on the containers.

Overview



The washer fluid reservoir is located under the hood.

Malfunction

The use of undiluted windshield washer fluid concentrate or alcohol-based anti-freeze can lead to incorrect readings at temperatures below +5 °F/-15 °C.

Maintenance

Vehicle features and options

This chapter describes model-specific equipment, systems, and functions that are currently available, or may become available in the future, even if they are not present in the vehicle.

Additional information:

Vehicle equipment, refer to page [8](#).

Maintenance system

Principle

The maintenance system provides service notifications and thereby provides support in maintaining road safety and the operational reliability of the vehicle.

General information

In some cases, scopes and intervals of the maintenance system may vary according to the country version. Replacement work, spare parts, fuels and lubricants, and wear materials are calculated separately. Further information is available from an authorized service center or another qualified service center or repair shop.

Safety information

Warning

Improperly performed work, in particular maintenance and repair on the high-voltage system, can lead to electric shock. There is a risk of injury, fire and danger to life.

It is recommended that the work on the vehicle, in particular maintenance and repair, is performed by an authorized service center or another qualified service center or repair shop.

Condition Based Service

Principle

Condition Based Service determines the maintenance recommendation using sensors and special algorithms that take into account the operating conditions of the vehicle.

Information on service notifications can be displayed on the Interaction Unit.

Additional information:

Service notifications, refer to page [159](#).

Service data in the vehicle key

Information on the service notifications is continuously stored in the vehicle key. An authorized service center can read this data out and suggest a maintenance scope for the vehicle.

Therefore, hand the service advisor the vehicle key with which the vehicle was driven most recently.

Stationary periods

Stationary periods during which the vehicle battery was disconnected are taken into account.

Some maintenance measures are time-dependent, e.g., replacing operating fluids. Have this maintenance work updated by an authorized service center or another qualified service center or repair shop.

Maintenance Booklet for US Models

Please consult your Maintenance Booklet for additional information on the performance of service and maintenance work.

The manufacturer of the vehicle recommends that maintenance and repair be performed by an authorized service center or another qualified service center or repair shop. Records of regular maintenance and repair work should be retained.

Diagnostic socket

Principle

Using the diagnostic socket, the vehicle owner can also have data saved to the vehicle read out, for a fee as required, by an authorized service center or another qualified service center or repair shop.

General information

Disconnect devices from the diagnostic socket before locking the vehicle.

Additional information:

Indicator/warning lights, refer to page [145](#).

Safety information

NOTICE

The socket for Onboard Diagnosis is an intricate component intended to be used in conjunction with specialized equipment to check the vehicle's primary emissions system. Improper use of the socket for Onboard Diagnosis, or contact with the socket for Onboard Diagnosis for other than its intended purpose, can cause vehicle malfunctions and creates risks of personal and property damage. As such, it is

strongly recommended that access to the diagnostic socket be limited to an authorized service center or another qualified service center or repair shop, or other persons who have specialized training and equipment and who are able to use the diagnostic socket correctly.

Overview

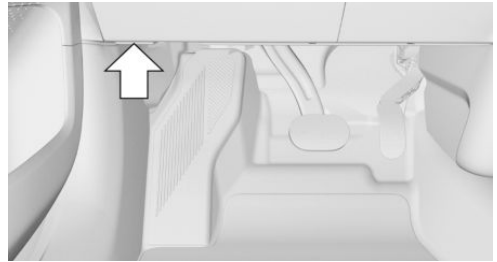

The diagnostic socket for reading out vehicle data is located on the driver's side.

Taking the vehicle out of service

When the vehicle is shut down for longer than three months, special measures must be taken. For more information, contact an authorized service center or another qualified service center or repair shop.

Additional information:

High-voltage battery service life, refer to page [345](#).

Replacing components

Vehicle features and options

This chapter describes model-specific equipment, systems, and functions that are currently available, or may become available in the future, even if they are not present in the vehicle.

Additional information:

Vehicle equipment, refer to page 8.

Onboard vehicle tool kit

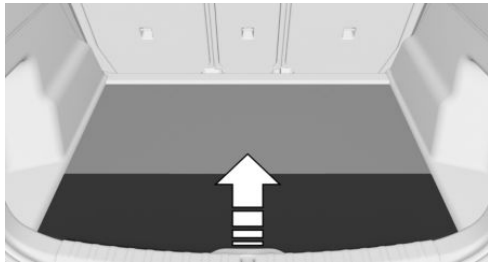

Depending on vehicle equipment, the onboard toolkit is located under the trunk floor or in a bag hanging on a free lashing eye in the trunk.

After use, stow the bag with onboard toolkit back under the trunk floor or on a lashing eye.

Wiper blades

Safety information

NOTICE

The window may sustain damage if the wiper falls onto it without the wiper blade installed. There is a risk of property damage. Hold the wiper firmly when changing the wiper blade. Do not fold in or switch on the wiper without a wiper blade installed.

NOTICE

Folded-out wipers can be jammed when the hood is opened. There is a risk of property damage. Make sure that the wipers with the wiper blades mounted are folded down onto the windshield before opening the hood.

Replacing the front wiper blades

To replace the front wiper blades, proceed as follows:

1. Move the wipers to the fold-out position.
2. Lift the wipers off the windshield and hold.



- Press the button on the wiper, arrow 1, turn the wiper blade clockwise slightly, then pull it forward and out, arrow 2.

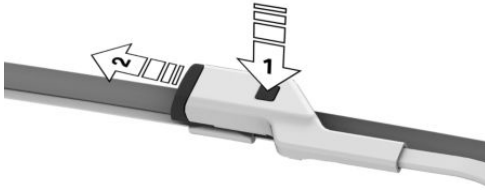

- Insert the new wiper blade by pressing it on until you hear it snap into the holder.
- Fold in the wipers.

Additional information:

Fold-out position of the wipers, refer to page 172.

Replacing the rear wiper blade

The rear wiper blade is engaged on the end of the wiper arm. To replace the wiper blade, proceed as follows:

- Push the lever on the wiper arm down, arrow 1, and pull off the wiper blade, arrow 2.



- Attach the new wiper blade. The wiper blade must engage audibly.

Lights and bulbs

Principle

The bulbs and lights contribute significantly to driving safety.

All headlights and lights are designed using LED technology at least.

In the event of a malfunction, the vehicle manufacturer recommends having any necessary work performed by an authorized service center or another qualified service center or repair shop.

Safety information

Warning

Intense brightness can irritate or damage the retina of the eye. There is a risk of injury. Do not look directly into the headlights or other light sources. Do not remove the LED covers.

Headlight glass

The inside of the headlight glass may fog up in cool or damp weather. Condensation will disappear after a short time when driving with the lights on. The headlight glass does not need to be changed.

If, despite driving with the headlights switched on, moisture such as water droplets increasingly forms in the light, have the headlights checked.

Vehicle battery

Principle

In addition to the high-voltage battery, the vehicle has a 12 volt vehicle battery. The vehicle battery supplies the onboard electronics with energy.

The vehicle battery is maintenance-free. More information on the vehicle battery can be requested from an authorized service center or another qualified service center or repair shop.

Safety information

DANGER

Contact with live components can lead to an electric shock. There is a risk of injury or danger to life. Do not touch any components that are under voltage.

Warning









Vehicle batteries that are not recommended can damage vehicle systems and impair vehicle functions. There is a risk of accident, injury, and property damage. Only use vehicle batteries recommended by the vehicle manufacturer. For information on suitable vehicle batteries, contact an authorized service center or another qualified service center or repair shop.

Registering the vehicle battery in the vehicle

The vehicle manufacturer recommends having an authorized service center or another qualified service center or repair shop register the vehicle battery to the vehicle after the battery has been changed. Once the battery has been registered again, all comfort features will be available without limitation and any Check Control messages displayed which relate to comfort features will disappear.

Hazard icons

The following hazard icons can be found on the vehicle battery:

Icon	Meaning
	No smoking, no open flames, no sparks.
	Wear safety goggles.
	Keep away from children.
	Risk of chemical burn: wear gloves, do not tilt battery.
	Flush acid splashes with water immediately. In the event of contact with the eyes or swallowing, seek a physician immediately.
	No direct daylight, no frost.
	Follow the operating instructions.
	Explosive gas mixture. Do not close any openings of the battery.

Charging the vehicle battery

A charger that is installed in the vehicle supplies the vehicle battery with power. The charger receives the necessary energy from the high-voltage battery.

Additional information:

Charge vehicle, refer to page 332.

Power interruption

After a power interruption, some equipment needs to be newly initialized or individual settings updated, for example:

- Initialize the parking brake.
- With memory function: Save the positions again.
- Update the time.
- Update the date.
- With glass sunroof: Initialize the system.

Additional information:

Initialize the parking brake after a power interruption, refer to page 139.

Disposing of old batteries



Have old batteries disposed of by an authorized service center or another qualified service center or repair shop, or take them to a collection point. Transport and store full vehicle batteries in an upright position. Secure the battery so that it does not tip over during transport.



Batteries contain harmful chemicals. It is prohibited by law to dispose of batteries together with household waste.

Fuses

General information

The fuses are located at different places in the vehicle.

Information on the fuse layout and the locations of fuse boxes is provided online: mini.com/fusecard.

Safety information

Warning

Incorrect and repaired fuses can overload electrical lines and components. There is a risk of fire, injury, and property damage. Never attempt to repair a blown fuse. Do not replace a nonworking fuse with a substitute of another color or amperage rating.

Replacing fuses

The vehicle manufacturer recommends having the fuses replaced by an authorized service center or another qualified service center or repair shop.

Breakdown Assistance

Vehicle features and options

This chapter describes model-specific equipment, systems, and functions that are currently available, or may become available in the future, even if they are not present in the vehicle.

Additional information:

Vehicle equipment, refer to page 8.

Hazard warning system



The button for the hazard warning system is located on the switch cluster.

The red light in the button flashes when the hazard warning system is turned on.

Warning triangle



The warning triangle is located in the tailgate.

Move the warning triangle sideways and remove it.

First-aid kit

Depending on the vehicle equipment and national-market version, the vehicle is equipped with a first-aid kit.

Storage for the first-aid kit is provided in the cargo area.

Some of the articles have a limited service life. Check the expiration dates for the contents regularly, replacing any expired items promptly.

MINI Assistance

Principle

MINI Assistance includes various services for the vehicle, e.g., customer support. The services help maintain mobility.

General information

The offering depends on the vehicle equipment and the national-market version.

For more information on possible services, the vehicle manufacturer recommends contacting an authorized service center or Customer Relations/Customer Support.

Starting services

1. To start MINI Assistance, go through the menu as follows: Apps menu / "All" / "MINI Assist".
2. Select the MINI Assistance option.

A voice connection to Customer Relations/customer support is being established.

MINI Roadside Assistance

Principle

MINI Roadside Assistance can be contacted if assistance is required following an accident.

General information

In the event of a breakdown, data on the vehicle's condition is sent to MINI Roadside Assistance.

There are various ways to contact MINI Roadside Assistance:

- Via additional text in the Check Control message.
- Via a call with a mobile phone.

Functional requirements

The following functional requirements must be met for MINI Roadside Assistance:

- An active MINI Connected contract, vehicle equipped with Intelligent Emergency Call or MINI Connected Services.
- Vehicle must have mobile network reception.
- Standby state is switched on.

Starting MINI Roadside Assistance manually

If the vehicle is equipped with Teleservices, support is first offered through Teleservice Diagnosis and, where applicable, then through Teleservice Help.

MINI Roadside Assistance can be started manually as follows:

1. Go through the menu as follows: Apps menu / "All" / "MINI Assist".
2. "MINI Roadside Assist." or select the desired service.

Note the views shown on the Interaction Unit. A voice connection is established as necessary.

Teleservice Diagnosis

Teleservice Diagnostics enables detailed vehicle data to be transmitted via mobile communications, which is necessary for vehicle diagnosis. This data is transmitted automatically. It may be necessary to approve this on the Interaction Unit.

Teleservice Help

Depending on the country, Teleservice Help enables an in-depth diagnosis of the vehicle by MINI Roadside Assistance via wireless transmission.

You can launch Teleservice Help by requesting it through MINI Roadside Assistance.

1. Park vehicle in a safe place.
2. Engage the parking brake.

3. Turn on the Interaction Unit.
4. Consent to Teleservice Help.

MINI Accident Assistance

Principle

MINI Accident Assistance can be contacted if assistance is required following an accident.

General information

If the vehicle sensors detect a minor to moderately severe accident in which the airbags did not deploy, a Check Control message is displayed on the Interaction Unit.

When MINI Accident Assistance is triggered, data on the vehicle's condition is sent to MINI.

Functional requirements

The following functional requirements must be met for MINI Accident Assistance:

- An active MINI Connected contract, vehicle equipped with Intelligent Emergency Call or MINI Connected Services.
- Vehicle must have mobile network reception.
- Standby state is switched on.

Starting MINI Accident Assistance

If an accident is detected automatically

Text for MINI Accident Assistance appears on the Interaction Unit.

The connection can be established directly: "Contact accident assistance"

The Check Control message for MINI Accident Assistance can also be brought up

from saved Check Control messages for a certain time.

Additional information:

Check Control, refer to page 144.

Starting MINI Accident Assistance manually

MINI Accident Assistance can also be contacted independently of the automatic accident detection function.

MINI Accident Assistance can be started manually as follows:

1. Go through the menu as follows: Apps menu / "All" / "MINI Assist".
2. "MINI Accident Assistance" or select the desired service.

Note the views shown on the Interaction Unit. A voice connection is established.

Emergency Call

Principle

In case of an emergency, an emergency call can be triggered automatically by the system or manually.

Intelligent emergency call

The vehicle features an Intelligent Emergency Call system, depending on vehicle equipment.

The Intelligent Assist system establishes a connection with the MINI Response Center.

Intelligent emergency calls are made using a SIM card that is integrated into the vehicle.

The MINI Response Center then makes contact with the vehicle occupants and initiates further action to help.

If an intelligent emergency call is made, the data used to determine necessary rescue

measures, e.g., the current location of the vehicle when it can be determined, is transmitted to the MINI Response Center.

Even if the driver is unable to respond, the MINI Response Center can, under certain circumstances, initiate steps to provide further assistance.

Even if the MINI Response Center can no longer be heard through the loudspeakers, the MINI Response Center may still be able to hear the vehicle occupants.

The MINI Response Center ends the emergency call.

General information

Only press the SOS button in the headliner in an emergency.

For technical reasons, the emergency call cannot be guaranteed under unfavorable conditions.

Overview



 The SOS button is located in the headliner.

Functional requirements

To use the emergency call, the following functional requirements must be met:

- Standby state is switched on.
- The Emergency Call system is functioning correctly.
- The integrated SIM card in the vehicle has been activated.

Automatic triggering

Under certain conditions, for example if the airbags are deployed, an emergency call is automatically triggered immediately after an accident of corresponding severity. Automatic Collision Notification is not affected by pressing the SOS button.

If an emergency call is placed, all other signal tones and audio sources such as the Park Distance Control are muted.

Manual triggering

To initiate an emergency call manually, proceed as follows:

1. Tap the cover flap.
 2. Press and hold the SOS button in the headliner until the LED near the button illuminates green.
- The LED is illuminated green when an Emergency Call has been initiated.

If a cancel prompt appears on the control display, the emergency call can be aborted.

If the situation allows, wait in the vehicle until the voice connection has been established.

- The LED flashes green when the connection to the MINI Response Center has been established.

Malfunction

The function of the emergency call may be impaired.

The LED near the SOS button flashes for approximately 30 seconds. A Check Control message is displayed.

Have the vehicle checked by an authorized service center or another qualified service center or repair shop.

What to do after an accident

General information

After an accident, take the following safety precautions for the high-voltage system:

- Apply the parking brake, then turn off drive-ready state and standby state.
- Secure the accident site.
- Lock the vehicle after exiting.
- Immediately inform the emergency responders, police, fire department, or towing service that the vehicle is equipped with high-voltage system.
- The vehicle must be recovered by an authorized service center or another qualified service center or repair shop.
- Do not inhale any gases escaping from the high-voltage battery; if needed, maintain a safe distance from the vehicle.

Safety information

DANGER

Contact with live components can lead to an electric shock. There is a risk of injury or danger to life. After an accident, do not touch any high-voltage components such as orange colored high-voltage cables or parts that are in contact with exposed high-voltage cables.

Warning

Fluids in the high-voltage battery are corrosive. There is a risk of injury. Do not touch fluids escaping from the high-voltage battery.

Jump-starting

Principle

Have only an authorized service center or another qualified service center or repair shop perform the jump-start.

Safety information

DANGER

Contact with live components can lead to an electric shock. There is a risk of injury or danger to life. Do not touch any components that are under voltage.

Towing

Safety information

Warning

When towing while safety systems or driver assistance systems are activated, the behavior of the individual systems may lead to an accident, e.g., due to automatic braking or acceleration. There is a risk of accident, injury, and property damage. Do not use the corresponding safety systems or driver assistance systems when towing.

Pushing the vehicle

To remove a broken-down vehicle from the hazard area, it can be pushed for distances of approx. 328 ft/100 m at a speed of max. 6 mph/10 km/h.

Additional information:

Rolling or pushing the vehicle, refer to page 130.

Transporting the vehicle

Principle

When towing the vehicle, make sure to tow it in the direction of traffic.

The vehicle must be transported by an authorized service center or another qualified service center or repair shop.

Safety information

NOTICE

The vehicle can be damaged when towing the vehicle while the front wheels are rolling. There is a risk of property damage. The front axle must be raised when the vehicle is towed, and the vehicle must be transported on a loading platform or using a tow dolly. Tow dollies must be used under the rear wheels only. Also make sure that no wheel is touching the ground.

Warning

The vehicle can become damaged when lifting and securing it. There is a risk of injury and risk of property damage.

- Only lift the vehicle using a suitable device.
- Do not lift or secure the vehicle on the towing eye, rims, body components, or chassis components.
- For transport, secure the vehicle by placing special tire straps over the tire tread surfaces in the vehicle's longitudinal direction.

Tow truck

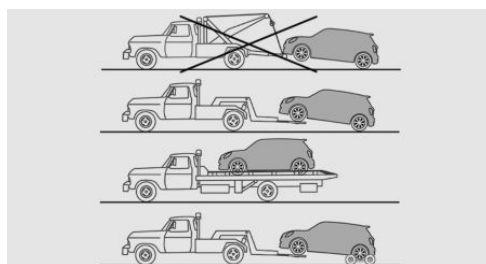

The vehicle should be transported with a tow truck with a so-called spectacle lift or on a loading platform.

When using a tow dolly, make sure that none of the wheels touch the ground. This method should be used for distances of 124 miles/200 km. Follow the instructions, as well as specified loads and speeds, given by the tow dolly manufacturer.

Towing other vehicles

Principle

Switch on the hazard warning system, depending on local regulations.

If the electrical system fails, mark the vehicle being towed clearly by placing a sign or warning triangle in the rear window.

Safety information

Warning

If the approved gross vehicle weight of the towing vehicle is lighter than the vehicle to be towed, the towing eye can tear off or it will not be possible to control vehicle handling. There is a risk of accident, injury, and property damage. Make sure that the gross vehicle weight of the towing vehicle is heavier than the vehicle to be towed.

Warning

Different levels of braking may occur when towing with adaptive recuperation. There is a risk of accident, injury, and property damage. Deactivate adaptive recuperation before towing.

NOTICE

If the tow bar or tow rope is attached incorrectly, damage to other vehicle parts can occur. There is a risk of property damage. Correctly attach the tow bar or tow rope to the towing eye.

Tow bar

The towing eyes used should be on the same side on both vehicles.

If it is not possible to avoid mounting the tow bar at an incline, note the following:

- Free movement will be restricted when cornering.
- The inclination of the tow bar will generate lateral forces.

Tow rope

Observe the following notes when using the tow rope:

- Use nylon ropes or straps, which will enable the vehicle to be towed without jerking.
- Make sure the tow rope is not twisted when fastening.
- Check the attachment of the towing eye and tow rope in regular intervals.
- Do not exceed a towing speed of 30 mph/50 km/h.
- Do not exceed a towing distance of 3 miles/5 km.
- When driving off to tow the vehicle, make sure that the tow rope is taut.

Towing eye

Principle

The towing eye is a device that can be screwed onto the vehicle in order to, e.g., secure tow cables or tow rods.

General information



The screw-in towing eye should always be carried in the vehicle.

The towing eye can be screwed in at the front or rear of the vehicle.

Safety information

NOTICE

If the towing eye is not used as intended, there may be damage to the vehicle or to the towing eye. There is a risk of property damage. Follow the notes on using the towing eye.

Storage

Depending on vehicle equipment, the towing eye may be stored in a bag as follows:

- In the cargo area under the cargo area floor.
- In the cargo area on the left or right side.
- In the cargo area behind a side trim panel.

Using the towing eye

When using the towing eye, note the following:

- Use only the towing eye provided with the vehicle.
- Turn the towing eye at least 5 turns clockwise and screw it in as far as it will go. If necessary, tighten with a suitable object.
- After use, unscrew the towing eye counter-clockwise.
- Use the towing eye for towing on paved roads only.
- Avoid lateral loading of the towing eye, for instance do not lift the vehicle by the towing eye.
- Check the attachment of the towing eye in regular intervals.

Towing eye thread



Press on the mark on the edge of the cover to push it out.

Vehicle care

Vehicle features and options

This chapter describes model-specific equipment, systems, and functions that are currently available, or may become available in the future, even if they are not present in the vehicle.

Additional information:

Vehicle equipment, refer to page 8.

Washing the vehicle

General information

The vehicle must be washed more frequently, especially in the winter. Intense contamination and road salt can damage the vehicle.

Foreign objects, e.g. leaves or snow, must be removed from the area below the windshield on a regular basis. The wipers can be folded down in order to clean the windshield completely.

Additional information:

Fold-out position of the wipers, refer to page 172.

Safety information

Warning

Contact with live components can lead to an electric shock. High voltage is present at the charging connection. There is a risk of injury or danger to life.

It is recommended that work on the charging connection, for example cleaning, is performed by an authorized service center or another qualified service center or repair shop.

NOTICE

When washing with an open charging socket flap, the charging socket can be damaged. There is a risk of damage to property. Close the charging socket flap before washing. Clean dirt behind the charging socket flap with a cloth.

Steam-jet cleaner and high pressure cleaner

Safety information

NOTICE

When using high-pressure cleaners, components can be damaged due to the pressure or high temperatures or because an insufficient distance was maintained. There is a risk of property damage. Maintain sufficient distance and do not spray too long continuously. Follow the operating instructions for the high pressure cleaners.

Distances and temperature

When using a steam/high-pressure cleaner, maintain the following distances and temperatures:

- Maximum temperature: 140 °F/60 °C.
- Minimum distance from sensors, cameras, seals and lights: 12 inches/30 cm.
- Minimum distance from glass sunroof: 31.5 in/80 cm.

Automatic car washes or car washes

Safety information

NOTICE

Improper use of automatic car washes can cause damage to the vehicle. There is a risk of property damage. Follow the following instructions:

- Give preference to cloth car washes or those that use soft brushes in order to avoid paint damage.
- Note the permissible vehicle dimensions for the car wash.
- Do not drive through a car wash with guide rails higher than 4 in/10 cm to avoid damage to the body.
- Observe the tire width of the guide rail to avoid damage to tires and rims.
- Fold in exterior mirrors to avoid damage to the exterior mirrors.
- Deactivate the wiper and, if necessary, rain sensor to avoid damage to the window wiper system.
- Take off all removable attachments, e.g., antennas.

Driving into a car wash

NOTICE

Selector lever position P is automatically engaged when standby state is switched off. The wheels are blocked. There is a risk of property damage. Do not switch off

standby if the vehicle is meant to coast, e.g., in a car wash.

In a car wash, the vehicle must be able to roll freely.

Some car washes do not permit persons in the vehicle. The vehicle cannot be locked from the outside when in selector lever position N. A signal sounds when an attempt is made to lock the vehicle.

Additional information:

Rolling or pushing the vehicle, refer to page [130](#).

Driving out of a car wash

Ensure that the vehicle key is in the car.

Turn on drive-ready state.

Additional information:

Drive-ready state, refer to page [47](#).

Lights

Do not rub wet lights dry, and do not use abrasive or acidic cleaning agents or cleaning agents containing alcohol.

Soak the area soiled by insects with an insect remover and rinse with water.

Thaw ice with de-icing spray, do not use an ice scraper.

After washing the vehicle

After washing the vehicle, apply the brakes briefly to dry them. Otherwise, their braking effect may be reduced. The heat generated while braking dries the brake disks and brake pads and protects them from corrosion.

Completely remove all wash residue, e.g., smearing, on the window glass to ensure sufficient visibility and to reduce wiper noise and wiper blade wear.

Vehicle care

Vehicle care products

General information

The manufacturer recommends using vehicle care and cleaning agents from MINI. Suitable vehicle care products are available from an authorized service center or another qualified service center or repair shop.

Safety information

Warning

Cleaning agents can contain substances that are dangerous and harmful to your health. There is a risk of injury and risk of property damage. When cleaning the interior, open the doors or windows. Only use cleaning agents that are intended for cleaning the respective component. Follow the instructions on the packaging.

Vehicle paintwork

General information

Regular vehicle care contributes to driving safety and value retention. Environmental influences in areas with elevated air pollution or natural contaminants can affect the vehicle paintwork. Environmental influences include tree resin or pollen, for example.

To prevent paint alteration and discoloration, remove corrosive substances immediately. Corrosive substances include oil, grease, or bird droppings, for example.

Matte paintwork

Only use cleaning and care products suitable for vehicles with matte paintwork.

Plastic wrap

Use only cleaning and care products that are suitable for vehicles with a plastic wrap.

Leather care

Dust and crumbs can work into pores and folds, causing heavy abrasion and premature degradation of the leather surface.

Clean leather regularly with a damp cloth or vacuum cleaner.

Certain clothes and other influences can cause discoloration of the leather. To prevent discoloration, clean and maintain the leather roughly every two months.

Clean light-colored leather more frequently because contamination on such surfaces is substantially more visible.

Use leather care products to preserve the protective layer of the leather.

To prevent leather alteration and discoloration, remove corrosive substances immediately. Corrosive substances include sunscreen, for example.

Synthetic leather care

Dust and crumbs can work into pores and folds, causing heavy abrasion and premature degradation of the artificial leather surface.

Clean synthetic leather regularly with a damp microfiber cloth or vacuum cleaner. In case of major soiling, use a moist soft sponge or microfiber cloth with suitable interior cleaners.

To prevent artificial leather alteration and discoloration, remove corrosive substances immediately. Corrosive substances include sunscreen, for example.

Fabric care

General information

In case of major soiling, use a moist soft sponge or microfiber cloth with suitable interior cleaners.

To prevent material alteration and discoloration, remove corrosive substances immediately. Corrosive substances include sunscreen, for example.

Safety information

NOTICE

Open hook and loop fasteners, zippers, or applications, e.g., studs on clothing can damage the seat covers and the other fabric and leather covers in the vehicle. There is a risk of property damage. Make sure that the fasteners are closed.

Upholstery material care

Vacuum the cushions regularly with a vacuum cleaner. Clean extensively down to the seams. Avoid rubbing the material vigorously.

Textile care

Using a damp microfiber cloth, clean the fabric regularly.

Alcantara

Use microfiber cloth soaked with water to clean minor soiling. Avoid rubbing the material vigorously.

Caring for special components

Displays, operating elements, and projection screen of the Head-up display

NOTICE

Surfaces can be damaged by improper cleaning, e.g., by using chemical cleaners, or from moisture or liquid of any kind. There is a risk of property damage.

- Avoid pressure that is too high and do not use any scratching materials.
- Use a dry, clean antistatic microfiber cloth for cleaning displays.
- Clean the operating elements and, depending on vehicle equipment, the projection screen of the Head-up display with a damp microfiber cloth and standard household dish soap.

Light-alloy wheels

Corrosive, acidic, or alkaline cleaning agents can damage the rim surface and the protective layer on adjacent components, e.g., the brakes.

When cleaning the vehicle, use only neutral rim cleaners with a pH value of 5 to 9. Do not use abrasive cleaning agents or steam-jet cleaners above 140 °F/60 °C. Follow instructions given by the manufacturer.

After cleaning, apply the brakes briefly to dry them. The heat generated while braking dries the brake disks and brake pads and protects them from corrosion.

Chrome surfaces

Carefully clean chrome-like surfaces, especially if exposed to road salt, using plenty of water and adding auto shampoo as needed.

Rubber components

Environmental influences can cause surface contamination of rubber parts and a loss of shine. Use only water and suitable cleaning agents for cleaning.

Treat especially worn rubber parts with rubber care products at regular intervals. To avoid damage or noise, use care products containing silicon to maintain the rubber sealing rings.

Wiper blades

The wiper blades are cleaned by using the window washer system.

To prevent a reduction in wiper quality, avoid cleaning the wiper blades manually unless necessary.

Fine wood parts

Clean the fine wood veneer and fine wood components with a damp cloth. Then dry with a soft cloth.

Plastic components

NOTICE

Solvent cleaners that contain alcohol or solvents such as lacquer thinners, cold cleaning agents, fuel and such, can damage plastic parts. There is a risk of property damage. Clean with a microfiber cloth. Dampen the cloth lightly with water, if needed.

When cleaning plastic parts, make sure that no fabric parts, e.g., the headliner, become wet.

Seat belts

Warning

Chemical solvent cleaners can destroy the fabric of the seat belts and lead to seat belts no longer having their protective effect. There is a risk of injury or danger to life. Use only a mild soap solution for cleaning the seat belts.

The seat belts should be cleaned for safety reasons. Dirty belt straps impede the reeling action and thus should be avoided for safety reasons.

Use only a mild soap solution for cleaning the installed belt straps.

Seat belts should only be allowed to retract if they are dry.

Carpets and floor mats

Warning

Objects in the driver's footwell can limit the pedal travel or block a depressed pedal. There is a risk of accident, injury, and property damage. Stow objects in the vehicle such that they are secured and cannot enter into the driver's footwell. Use floor mats that are suitable for the vehicle and can be safely attached to the floor. Do not use loose floor mats and do not layer several floor mats. Make sure that there is sufficient clearance for the pedals. Ensure that the floor mats are securely fastened again after they were removed, for instance for cleaning.

The floor mats can be removed from the interior for cleaning.

If the carpets are heavily soiled, clean them with a microfiber cloth and water or a fabric cleaner. Rub back and forth in the direction

of travel to prevent the carpet from becoming matted.

Sensors and camera lenses

General information

To clean sensors and camera lenses, use a cloth moistened with a small amount of glass detergent.

Cleaning the rearview camera

When the rear window is cleaned, the rearview camera is also cleaned automatically.

Technical data

Vehicle features and options

This chapter describes model-specific equipment, systems, and functions that are currently available, or may become available in the future, even if they are not present in the vehicle.

Additional information:

Vehicle equipment, refer to page 8.

General information

The technical data and specifications in the Owner's Manual are used as guidance values. Vehicle-specific data may deviate from

this, for instance due to the optional equipment chosen, national-market version, or country-specific measuring process. More specific values can be obtained in approval documents, on the vehicle info label, or from an authorized service center or another qualified service center or repair shop.

Dimensions

The dimensions can vary depending on the model version, equipment version or country-specific measurement procedure.

The height of the vehicle can also differ, e.g., due to tires and vehicle load.

Detailed technical data

MINI Countryman Dimensions

Width with mirrors	in	81.5
	mm	2,069
Width without mirrors	in	72.6
	mm	1,843
Height	in	64.6
	mm	1,640
Length	in	175.0
	mm	4,444
Wheelbase	in	106.0
	mm	2,692

MINI Countryman**Dimensions**

Turning circle Ø	ft	38.7
	m	11.8

MINI Countryman SE ALL4**Weight**

Maximum permissible payload	lb	1,025
	kg	465
Maximum permissible total weight	lb	5,666
	kg	2,570
Maximum permissible front axle load	lb	2,734
	kg	1,240
Maximum permissible rear axle load	lb	3,175
	kg	1,440

MINI Countryman SE ALL4**Trailer towing**

Maximum permissible trailer load without brakes	lb	1,653
	kg	750
Maximum permissible trailer load, braked, 12 % gradient	lb	2,646
	kg	1,200
Maximum permissible drawbar nose weight	lb	265
	kg	120
Maximum permissible rear axle load, towing vehicle	lb	3,175
	kg	1,440
Maximum permissible total weight, towing vehicle	lb	5,666
	kg	2,570

Appendix

General information

Any updates to the Owner's Manual of the vehicle are listed here.

Everything from A to Z

Index

0-9

3D view [257](#)

A

ABS, see Antilock Braking System [216](#)

Acceleration Assistant, see Launch Control [134](#)

Acceleration sensor, see G-Meter [158](#)

Accelerator pedal positions [131](#)

Accessories and parts [10](#)

AC charging station, see Charging vehicle [332](#)

Accident Assistance, see MINI Accident Assistance [386](#)

Accident prevention, see Active Protection [212](#)

Accident, what to do [388](#)

Acoustic pedestrian protection [127](#)

AC quick charging cable, see Mode 3 charging cable [334](#)

Activated carbon filter, see Interior filter [291](#)

Activation points, panorama view [259](#)

Activation, trailer towing [321](#)

Activation word [56](#)

Active Blind Spot Detection [195](#)

Active Cruise Control, Distance Control, see Speed control systems [223](#)

Active Guard, see Collision warning systems [178](#)

Active Park Distance Control [265](#)

Active Protection [212](#)

Adaptive lighting functions [167](#)

Adaptive recuperation [327](#)

Additional camera view displays [252](#)

Adjusting driving dynamics, see MINI Modes [135](#)

Adjusting speed to route [247](#)

Advance climate control, see Pre-conditioning [291](#)

Advanced Real Time Traffic Information, see Owner's Manual for Navigation, Entertainment, Communication [6](#)

Airbags [174](#)

Airbags, warning light [176](#)

Air circulation, see Recirculated-air mode [287](#)

Air conditioning, climate [286](#)

Air distribution, manual [286](#)

Air drying, see air conditioning [286](#)

Air flow, automatic climate control [286](#)

Air outlets, see Ventilation [290](#)

Air pressure, tires [347](#)

Air quality [290](#)

Air vent, see Ventilation [290](#)

Alarm, avoiding [96](#)

Alarm signal, high-voltage battery [20](#)

Alarm system [95](#)

ALL4 [219](#)

All-season tires, see Winter tires [354](#)

All-season tires, tread [352](#)

All-wheel drive, see ALL4 [219](#)

Amazon Alexa Car Integration [59](#)

Ambient light [169](#)

Android Auto, see Owner's Manual for Navigation, Entertainment, Communication [6](#)

Antifreeze, see Washer fluid [376](#)

Antilock Braking System [216](#)

Anti-theft protection, lug bolt lock [369](#)

Anti-trap mechanism, glass sunroof [102](#)

Anti-trap mechanism, windows [99](#)

Apple CarPlay, see Owner's Manual for Navigation, Entertainment, Communication [6](#)

Applications, see Owner's Manual for Navigation, Entertainment, Communication [6](#)

Apps, see Owner's Manual for Navigation, Entertainment, Communication [6](#)

Aquaplaning [313](#)

- Articulation angle, Trailer Assistant [322](#)
- Artificial engine noise, see Acoustic pedestrian protection [127](#)
- Assistance, MINI [384](#)
- Assistance with breakdown [384](#)
- Assistance with driving off on inclines, see drive-off assistant [137](#)
- Assisted Driving Mode, lane keeping, see Speed control systems [223](#)
- Assisted Driving Mode Plus, see Speed control systems [223](#)
- Assisted View [157](#)
- Audio, see Owner's Manual for Navigation, Entertainment and Communication [6](#)
- Authorized service center, see MINI Accident Assistance [386](#)
- Authorized service center, see MINI Roadside Assistance [385](#)
- AUTO H, see Automatic Hold [140](#)
- Automatic camera perspective [255](#)
- Automatic climate control [283](#)
- Automatic control, headlight [164](#)
- Automatic Curb Monitor, exterior mirror [116](#)
- Automatic deactivation, front-seat passenger airbags [177](#)
- Automatic deactivation, high-voltage system [20](#)
- Automatic dimming, see Automatic High Beam Assistant [161](#)
- Automatic headlight control [164](#)
- Automatic High Beam Assistant [161](#)
- Automatic Hold [140](#)
- Automatic lights mode [167](#)
- Automatic locking [94](#)
- Automatic Parking Assistant [268](#)
- Automatic Parking Assistant Professional [268](#)
- Automatic Parking Assistant, see Maneuver Assistant [274](#)
- Automatic program, automatic climate control [284](#)
- Automatic time setting [158](#)
- Automatic unlocking [94](#)
- Automatic wiper system, see Rain sensor [171](#)
- AUTO program, automatic climate control [284](#)

B

- Backrest curvature, see Lumbar support [107](#)
- Backrest, seats [104](#)
- Backrest tilt [106](#)
- Backrest tilt, rear seats [108](#)
- Back-up Assistant [279](#)
- Balance Mode, see MINI Modes [135](#)
- Ball head, removable [319](#)
- Bandages, see First-aid kit [384](#)
- Bar for tow-starting/towing [390](#)
- Battery, charge state indicator [155](#)
- Battery, charging see Vehicle, charging [332](#)
- Battery, disposal [383](#)
- Battery heat management, see Preparing the high-voltage battery [339](#)
- Battery high-voltage system, long stationary periods [345](#)
- Battery, vehicle [381](#)
- B Brake, see Gear position B [129](#)
- Being towed, see Towing [388](#)
- Belts, see Seat belts [109](#)
- Beverage holder, front [301](#)
- Beverage holder, rear [302](#)
- Blind spot collision warning [195](#)
- Blocking, power window, see Safety switch [99](#)
- Blower, see Air flow [286](#)
- Bluetooth audio, see Owner's Manual for Navigation, Entertainment, Communication [6](#)
- Bluetooth connection, see Owner's Manual for Navigation, Entertainment, Communication [6](#)
- Boost Control function [134](#)
- Boost, see Boost Control [134](#)
- Boost, see Sport Boost function [134](#)
- Bottle holder, front, see Cup holder, front [301](#)
- Bottle holder, rear, see Cup holder, rear [302](#)
- Brake assistant [216](#)
- Brake Controller [325](#)

Brake disks, see Brake system 312
 Brake pads, see Brake system 312
 Brake, see Gear position B 129
 Brake system 312
 Braking, information 314
 Breakdown assistance 384
 Break-in 312
 Break-in procedures 312
 Break recommendation, see Fatigue alert 213
 Brightness, Interaction Unit 53
 Button, central locking system 92
 Buttons on the steering wheel 36
 Button, SOS, see Intelligent emergency call 386
 Button, Start/Stop, see Start/Stop button 127
 Bypassing, see Jump-starting 388

C

Cable for tow-starting/towing 390
 Calibration of the front seats 107
 California Proposition 65 Warning 10
 Camera cleaning 397
 Camera, instrument panel, see Driver Attention Camera 214
 Camera lenses, care 397
 Camera perspective, automatic 255
 Camera perspective, semi-automatic 255
 Camera, rearview camera 254
 Cameras, see Vehicle sensors 40
 Camera view aid lines 252
 Care 392
 Care, displays, screens 395
 Care, Head-up display 395
 Care, light-alloy wheels 395
 Care, vehicle 394
 Cargo 304
 Cargo area 304
 Cargo area, enlarging 308
 Cargo cover 309
 Cargo position, rear seat backrest 308
 Cargo straps, see Lashing eyes in the cargo area 305
 Car key, see Vehicle key 74

Carpet, care 396
 Car seats, see Transporting children safely 120
 Car wash 392
 Car wash, automatic 392
 Car wash view 258
 CBS, see Condition Based Service 378
 Cell phone, see Owner's Manual for Navigation, Entertainment and Communication 6
 Center console 38
 Central locking switch, see Central locking system 92
 Central locking system 92
 Changes, technical, see For Your Own Safety 9
 Change, wheels and tires 353
 Changing parts 380
 Changing wheels 368
 CHARGE, energy recovery 17
 Charge state indicator, high-voltage battery 155
 Charging cable, high-voltage battery 334
 Charging cradle 295
 Charging display 156
 Charging process, see Charging display 156
 Charging, see Vehicle, charging 332
 Charging settings, location-based 344
 Charging smartphone, see Wireless charging tray 295
 Charging status, indicator light on the charging socket 340
 Charging status indicator, see Charging display 156
 Charging tray for smartphones, see Wireless charging tray 295
 Charging, vehicle 332
 Chassis number, see Vehicle identification number 14
 Check Control 144
 Children, seating position 120
 Children, transporting safely 120
 Child restraint seats 120
 Child restraint system LATCH 123
 Child restraint systems, mounting 121
 Child restraint systems, see Transporting children safely 120

- Child safety latch [125](#)
 - Child safety locks [125](#)
 - Child seat installation [121](#)
 - Child seat, mounting [121](#)
 - Child seats, see Transporting children safely [120](#)
 - Chrome-plated surfaces, care [395](#)
 - Chrome surfaces, care [395](#)
 - Cleaning, see Care [394](#)
 - Climate control [283](#)
 - Closing with smartphone, see MINI Digital Key [89](#)
 - Closing with the Key Card [88](#)
 - Clothes hooks [302](#)
 - Coasting [328](#)
 - Coasting with idling engine [328](#)
 - Coat hooks [302](#)
 - Collision warning systems [178](#)
 - Comfort Access [82](#)
 - Comfort entry [109](#)
 - Comfort exit [109](#)
 - Communication, see Owner's Manual for Navigation, Entertainment and Communication [6](#)
 - Comparison of entries, see Entry comparison [52](#)
 - Compartments in the doors [301](#)
 - Compressor [356](#)
 - Condensation water under the parked vehicle [315](#)
 - Condensation, windshield [288](#)
 - Condition Based Service [378](#)
 - Connecting mobile devices to the vehicle [59](#)
 - Connection, electrical devices, see Sockets [293](#)
 - Contactless trunk opening/closing [87](#)
 - Contacts, see Owner's Manual for Navigation, Entertainment, Communication [6](#)
 - Contact with water, high-voltage system [19](#)
 - Continued driving with a flat tire, see Tire Pressure Monitor [359](#)
 - Continued driving with flat tire, see Flat tire monitor [366](#)
 - Control display, see MINI Interaction Unit [49](#)
 - Control systems, driving stability [216](#)
 - Convoy Assistant, Assisted Driving Mode Plus, see Speed control systems [223](#)
 - Coolant [376](#)
 - Cooling, maximum [287](#)
 - Cooling system [376](#)
 - Core Mode, see MINI Modes [135](#)
 - Cornering light [167](#)
 - Corrosion, brake disks [315](#)
 - Cosmetic mirror [293](#)
 - Cross Traffic Warning [206](#)
 - Cruise Control, Cruise Control, see Speed control systems [223](#)
 - Cruise Control, see Speed control systems [223](#)
 - Cup holder, front [301](#)
 - Cup holder, rear [302](#)
 - Customer support [384](#)
- ## D
- Damage, tires [352](#)
 - Dashboard [36](#)
 - Dashcam, see Drive Recorder [209](#)
 - Data memory [11](#)
 - Data protection, settings [66](#)
 - Data, see Personal data, deleting [66](#)
 - Data, technical [398](#)
 - Date [158](#)
 - Day, see Date [158](#)
 - Daytime driving lights [166](#)
 - Daytime running lights [166](#)
 - DC charging cable [334](#)
 - Deceleration and energy recovery [131](#)
 - Defrosting, windshield [288](#)
 - Deleting, personal data [66](#)
 - Departure schedule, see Pre-conditioning [291](#)
 - Departure time, pre-conditioning [292](#)
 - Destination input [6](#)
 - Diagnostic connection [379](#)
 - Diagnostic socket [379](#)
 - Digital Key [89](#)
 - Digital key, see MINI Digital Key [89](#)
 - Dimmable interior mirror [117](#)
 - Dimming exterior mirror [116](#)
 - Direct access [55](#)

- Direct access buttons [55](#)
 - Direct dial buttons, see Shortcuts [52](#)
 - Display and operating concept [49](#)
 - Display charge state, high-voltage battery [155](#)
 - Display, GREEN Mode [328](#)
 - Display lighting, see Instrument lighting [167](#)
 - Displays [142](#)
 - Displays and icons [8](#)
 - Display speed limit, see Speed Limit Info [221](#)
 - Disposal, vehicle battery [383](#)
 - Distance Control, see Speed control systems [223](#)
 - Distance to vehicle driving ahead, see Speed control systems [223](#)
 - Distance Warning, see Park Distance Control [262](#)
 - Door handle lighting, see Welcome lights [165](#)
 - Door opening angle [260](#)
 - Downhill control, see Hill Descent Control [219](#)
 - Drive-off assistant [137](#)
 - Drive-off monitoring [267](#)
 - Drive-off support [219](#)
 - Drive power reduced [151](#)
 - Driver activity, see Driver Attention Camera [214](#)
 - Driver Assistance, parking, see Parking assistance systems [249](#)
 - Driver assistance systems [221](#)
 - Driver Attention Camera, see Driver Attention Camera [214](#)
 - Drive-ready state in detail [128](#)
 - Drive-ready state, see Operating state of vehicle [45](#)
 - Drive-ready state, turning off [128](#)
 - Drive-ready state, turning on [128](#)
 - Drive Recorder [209](#)
 - Driver profiles [67](#)
 - Driver profiles, welcome screen [67](#)
 - Drive sound, see MINI Sound [282](#)
 - Driving [127](#)
 - Driving Assistant, see Collision warning systems [178](#)
 - Driving comfort [282](#)
 - Driving Dynamics Control, see MINI Modes [135](#)
 - Driving dynamics, setting [218](#)
 - Driving in detail [131](#)
 - Driving information [54](#)
 - Driving mode, GREEN [328](#)
 - Driving Mode, see MINI Modes [135](#)
 - Driving notes [312](#)
 - Driving off, see Drive-off support [219](#)
 - Driving on poor roads [315](#)
 - Driving, see Drive-ready state in detail [128](#)
 - Driving stability control systems [216](#)
 - Driving through flood [313](#)
 - Driving through water [313](#)
 - Driving tips, see General driving notes [312](#)
 - DSC, see Dynamic Stability Control [216](#)
 - DTC, see Setting for increased driving dynamics [218](#)
 - Dynamic Stability Control [216](#)
 - Dynamic Traction Control, see Setting for increased driving dynamics [218](#)
- ## E
- eDRIVE, see Electric drive [16](#)
 - Efficiency Coach, Green Mode [329](#)
 - Electric drive [16](#)
 - Electric drive, see Driving in detail [131](#)
 - Electric driving, see Electric drive [16](#)
 - Electric range [153](#)
 - Electromechanical parking brake [137](#)
 - Electronic stability program, see Dynamic Stability Control [216](#)
 - Emergency brake, see Emergency Stop Assistant [205](#)
 - Emergency braking, see PostCrash iBrake [213](#)
 - Emergency call [386](#)
 - Emergency release, transmission lock [131](#)
 - Emergency service, see MINI Roadside Assistance [385](#)
 - Emergency Stop Assistant [205](#)
 - Energy recovery and deceleration [131](#)

Energy recovery, CHARGE [17](#)
Engine compartment, see Under the hood [373](#)
Engine idling when driving, see Coasting [328](#)
Engine noise, artificial, see Acoustic pedestrian protection [127](#)
Engine sound, see MINI Sound [282](#)
Engine start, see Jump-starting [388](#)
Entering a destination, see Owner's Manual for Navigation, Entertainment, Communication [6](#)
Entering an address, navigation, see Owner's Manual for Navigation, Entertainment and Communication [6](#)
Entertainment, see Owner's Manual for Navigation, Entertainment and Communication [6](#)
Entertainment, selection list in the instrument cluster [152](#)
Entry assistance, exit assistance [109](#)
Entry comparison [52](#)
Error indicators, see Check Control [144](#)
eSIM telephony, see Owner's Manual for Navigation, Entertainment, Communication [6](#)
ESP, see Dynamic Stability Control [216](#)
Evasion Assistant, see Forward Collision Mitigation [180](#)
Event Data Recorder EDR [14](#)
Exchange, wheels and tires [353](#)
Exit Warning [189](#)
Experience switch, see MINI Modes [135](#)
Exterior lighting, locked vehicle [166](#)
Exterior mirror [115](#)
Exterior mirror, Automatic Curb Monitor [116](#)
Exterior mirror cameras, see Vehicle sensors [40](#)
External start, see Jump-starting [388](#)
Eye for towing [390](#)
Eyes, see Lashing eyes in the cargo area [305](#)

F

Factory settings, see Vehicle data, resetting [67](#)
Failure message, see Check Control [144](#)
Fastening seat belts, see Seat belts [109](#)
Fatigue Alert [213](#)
Fatigue warner, see Fatigue Alert [213](#)
Fault indicators, see Check Control [144](#)
Filter, see Interior filter [291](#)
Fine wood parts, care [396](#)
First-aid kit [384](#)
Fittings for trailer safety chain, trailer towing [320](#)
Flat tire, changing wheels [368](#)
Flat tire, continued driving, see Flat tire monitor [366](#)
Flat tire, continued driving, see Tire Pressure Monitor [359](#)
Flat tire message, see Flat tire monitor [367](#)
Flat tire message, see Tire Pressure Monitor [362](#)
Flat tire monitor [366](#)
Flat tire, repairing [355](#)
Flat tire, see Flat tire monitor [366](#)
Flat tire, see Tire Pressure Monitor [359](#)
Flat tire warning light, see Flat tire monitor [367](#)
Flat tire warning light, see Tire Pressure Monitor [362](#)
Flexible Fast Charger [335](#)
Floor carpet, care [396](#)
Floor mats, care [396](#)
Fold-away position, wiper [172](#)
Fold-out position [172](#)
Foot brake [314](#)
Forward Collision Mitigation [180](#)
Forward Collision Warning, see Forward Collision Mitigation [180](#)
For Your Own Safety [9](#)
Front airbags [174](#)
Front camera, see Vehicle sensors [40](#)
Front lights, replacing, see Lights and bulbs [381](#)

Front passenger's side exterior mirror, tilting down, see Automatic Curb Monitor [116](#)
 Front passenger airbags, automatic deactivation [177](#)
 Front radar sensor, see Vehicle sensors [40](#)
 Front-seat passenger airbag, indicator light [177](#)
 Front seats [104](#)
 Fuses [383](#)

G

Gear position B [129](#)
 Gear position, see Selector lever positions [128](#)
 General driving notes [312](#)
 Glare shield, see Sun visor [293](#)
 Glass sunroof [100](#)
 Glass sunroof, initializing the glass sunroof and sun protection [103](#)
 Glove compartment [300](#)
 G-Meter [158](#)
 Go Kart Mode, see MINI Modes [135](#)
 GPS navigation, navigation, see Owner's Manual for Navigation, Entertainment, Communication [6](#)
 GREEN Mode [328](#)
 Green Mode, see MINI Modes [135](#)
 Guest profile, see MINI ID [67](#)

H

Handbrake, see Parking brake [137](#)
 Hands-free device, see Owner's Manual for Navigation, Entertainment, Communication [6](#)
 Hands-free system [6](#)
 Hazard warning system [384](#)
 HDC, see Hill Descent Control [219](#)
 Head airbag [175](#)
 Headlight control, automatic [164](#)
 Headlight flasher [160](#)
 Headlight glass [381](#)
 Headlights, care [393](#)

Headlights, replacing, see Lights and bulbs [381](#)
 Headlights, turning up, dimming, see Automatic High Beam Assistant [161](#)
 Headliner [39](#)
 Head restraints and seats [104](#)
 Head restraints, front [112](#)
 Head restraints, rear [113](#)
 Head-up display [143](#)
 Head-up display, care [395](#)
 Head-up display, store position, see Memory function [118](#)
 Heated steering wheel [289](#)
 Heavy cargo, stowing [305](#)
 High-beam headlights [160](#)
 Higher speed range [313](#)
 High-voltage battery, alarm signal [20](#)
 High-voltage battery, charge state indicator [155](#)
 High-voltage battery, heated [134](#)
 High-voltage battery, heavily discharged [133](#)
 High-voltage battery, long stationary periods [345](#)
 High-voltage battery, service life [345](#)
 High-voltage battery, vehicle shutdown [345](#)
 High-voltage system, automatic deactivation [20](#)
 High-voltage system battery, vehicle shutdown [345](#)
 High-voltage system, contact with water [19](#)
 High-voltage system, safety [19](#)
 High-voltage system, work [19](#)
 Highway Assistant, Assisted Driving Mode Plus, see Speed control systems [223](#)
 Hill Ascent Control, see drive-off assistant [137](#)
 Hill Descent Control [219](#)
 Hills [314](#)
 Hill-start assist, see drive-off assistant [137](#)
 Homepage, see Internet [7](#)
 Hood [373](#)
 Horn [36](#)
 Hotline, see Customer support [384](#)
 Hour, see Time [158](#)

I

iBrake PostCrash 213
Ice warning, see Outside temperature 158
Icons and displays 8
Identification marks, tires 350
Identification number, see Vehicle identification number 14
Idle state, see Operating state of vehicle 45
Illustration, MINI Interaction Unit 51
Inclination 106
Increasing the range 327
Indicator light, front-seat passenger air-bag 177
Indicator light on the charging socket, see Display, charging status 340
Indicator lights 145
Individual air distribution 286
Individual settings, see MINI ID 67
Inductive charging, smartphone, see Wireless charging tray 295
Influencing the range, see Range prediction 154
Information 6
Information on Driver Assistance, displaying, see Assisted View 157
Initialization, see flat tire monitor 366
Input, MINI Interaction Unit 51
Installation of child restraint systems 121
Instrument cluster, see Driving information 54
Instrument lighting 167
Integrated key 76
Integrated Owner's Manual in the vehicle 6
Intelligent emergency call 386
Intelligent Personal Assistant 55
Intelligent Safety, see Collision warning systems 178
Intended use 9
Interaction Unit 49
Interior camera 296
Interior equipment 293
Interior filter 291
Interior lights 168
Interior lights, locked vehicle 166
Interior mirror 117

Interior mirror, automatic dimming feature 117
Interior mirror, manually dimmable 117
Interior motion sensor 96
Internet page 7
Intersection Collision Warning, see Forward Collision Mitigation 180
Interval indicator, see Service notifications 159

J

Jacking points 370
Jacking points for the vehicle jack 370
Jump-starting 388

K

Key Card 88
Keyless Go, see Comfort Access 82
Key, mechanical 76
Key, see Vehicle key 74
Knee airbag 175

L

Labeling 350
Lane boundary 191
Lane Change Assistant 239
Lane change with active destination guidance 240
Lane departure warning 191
Lane Keeping Assistant with active side collision protection, see Side Collision Warning 198
Lane keeping, Assisted Driving Mode, see Speed control systems 223
Lane lines, additional camera view displays 252
Lane threshold, warning 191
Language, setting 57
Lashing eyes in the cargo area 305
LATCH child restraint system 123
Lateral Parking Aid 255
Launch Control 134

Leather care [394](#)
 LED headlights, changing, see Lights and bulbs [381](#)
 Letters and numbers, entering [51](#)
 Level 1 charging cable, see Mode 2 charging cable [334](#)
 Level 1 charging, see Charging vehicle [332](#)
 Level 2 charging cable, see Mode 3 charging cable [334](#)
 Level 3 charging cable, see DC charging cable [334](#)
 Light-alloy wheels, care [395](#)
 Light in exterior mirror, see Active Blind Spot Detection [195](#)
 Light in exterior mirror, see Cross Traffic Warning [206](#)
 Lighting [163](#)
 Light replacement, see Lights and bulbs [381](#)
 Lights [160](#)
 Lights and bulbs [381](#)
 Lights, care [393](#)
 Light switch [163](#)
 List, instrument cluster, see Selection lists [152](#)
 Load [305](#)
 Loading [304](#)
 Loading position [308](#)
 Loading the cargo area, see Cargo [304](#)
 Local time, see Time [158](#)
 Location-based charging settings [344](#)
 Locking, see Opening and Closing [74](#)
 Locking, settings [93](#)
 Lock, lug bolts [369](#)
 Long stationary periods, high-voltage battery [345](#)
 Loop, see Towing eye [390](#)
 Low-beam headlights [164](#)
 Lower back support, see Lumbar support [107](#)
 Lug bolt lock [369](#)
 Luggage rack, refer to Roof bars [316](#)
 Luggage straps [305](#)
 Lumbar massage, see Seat massage [107](#)
 Lumbar support [107](#)

M

Maintenance [378](#)
 Maintenance recommendation, see Condition Based Service [378](#)
 Maintenance system [378](#)
 Make-up mirror [293](#)
 Malfunction, vehicle key [79](#)
 Maneuver Assistant [274](#)
 Manually unlocking doors, see Integrated key [76](#)
 Matte paintwork [394](#)
 Matt paint, care [394](#)
 Maximum cooling [287](#)
 Maximum range, see Max Range [330](#)
 Maximum speed, display, see Speed Limit Info [221](#)
 Maximum speed, winter tires [354](#)
 Max Range [330](#)
 Measurement indicator, see Driving information [54](#)
 Medical supplies, see First-aid kit [384](#)
 Memory function [118](#)
 Messages, see Check Control [144](#)
 Messages, see Owner's Manual for Navigation, Entertainment, Communication [6](#)
 Microfilter, see Interior filter [291](#)
 MINI Accident Assistance [386](#)
 MINI Connected, see Owner's Manual for Navigation, Entertainment, Communication [6](#)
 MINI Digital Key [89](#)
 MINI Electric, see Electric drive [16](#)
 MINI EXPERIENCE Modes, see MINI Modes [135](#)
 MINI ID [67](#)
 MINI Intelligent Personal Assistant [55](#)
 MINI Interaction Unit [49](#)
 MINI maintenance system, see Maintenance system [378](#)
 MINI Modes [135](#)
 Minimum tread depth, tires [352](#)
 MINI Remote Software Upgrade [61](#)
 MINI Roadside Assistance [385](#)
 MINI Sound [282](#)
 Minute, see Time [158](#)

Mobile communications in the vehicle [313](#)
Mobile devices, connecting [59](#)
Mobile phone, see Owner's Manual for Navigation, Entertainment and Communication [6](#)
Mobile Service, see MINI Accident Assistance [386](#)
Mobile Service, see MINI Roadside Assistance [385](#)
Mobility system, see Tire repair set [355](#)
Mode 2 charging cable [334](#)
Mode 2 charging, see Vehicle, charging [332](#)
Mode 3 charging cable [334](#)
Mode 4 charging cable, see DC charging cable [334](#)
MODE button, see Speed control systems [223](#)
Modifications, technical, see For Your Own Safety [9](#)
Moisture in headlight, see Headlight glass [381](#)
Monitoring of the high-voltage battery [20](#)
Mount for trailer hitch, care [319](#)
Mounting of child restraint systems [121](#)
Mug holder, front, see Cup holder, front [301](#)
Mug holder, rear, see Cup holder, rear [302](#)
Multifunction hook [306](#)
Multi-function steering wheel [36](#)
Multifunction steering wheel, buttons [36](#)

N

Neck restraints, front, see Head restraints, front [112](#)
Neck restraints, rear, see Head restraints, rear [113](#)
Net, cargo area [306](#)
Neutral cleaner, see Light-alloy wheels, care [395](#)
Notifications, see Owner's Manual for Navigation, Entertainment, Communication [6](#)
No-touch opening and closing of the tailgate [87](#)
No Turn on Red function [204](#)
Nylon rope for tow-starting/towing [390](#)

O

OBD, see On-board diagnosis [379](#)
Obstacle marking, additional camera view displays [252](#)
OFF indicator, see Standby and drive-ready state [152](#)
Off-road driving, see Driving on poor roads [315](#)
Old battery [383](#)
On-board diagnosis [379](#)
Onboard toolkit [380](#)
On-call service, see MINI Accident Assistance [386](#)
On-call service, see MINI Roadside Assistance [385](#)
One-touch signaling [160](#)
Opening and closing [74](#)
Opening with smartphone, see MINI Digital Key [89](#)
Opening with the Key Card [88](#)
Operating elements, center console [38](#)
Operating fluids [376](#)
Operating menus, MINI Interaction Unit [49](#)
Operating principle of MINI Interaction Unit [49](#)
Operating state of vehicle [45](#)
Operation via voice [55](#)
Optional equipment, see Vehicle equipment [8](#)
Outside temperature [158](#)
Overwintering, see Long-term vehicle storage [379](#)

P

Paint, vehicle care [394](#)
Paintwork [394](#)
Panic alarm, see Panic mode [96](#)
Panic mode [96](#)
Panorama View [258](#)
Panorama View, see Panorama View [258](#)
Panoramic glass sunroof, see Glass sunroof [100](#)
Park Distance Control [262](#)

Parked car ventilation, see Pre-conditioning 291

Parking aid lines, additional camera view displays 252

Parking assistance systems 249

Parking assistant 268

Parking Assistant Plus, see Parking assistance systems 249

Parking Assistant Professional, see Parking assistance systems 249

Parking Assistant, see Park Distance Control 262

Parking Assistant, see Parking assistance systems 249

Parking brake 137

Parking brake function, see Active Park Distance Control 265

Parking lights 165

Parking with Automatic Hold 140

Parts and accessories 10

Pathway lighting 166

Pathway lighting, turning on 166

Payload 305

PDC, see Park Distance Control 262

Pedestrian protection, acoustic 127

Pedestrian Warning, see Forward Collision Mitigation 180

Performance display, see Sport displays 157

Personal Assistant 55

Personal data, deleting 66

Personal eSIM, see Owner's Manual for Navigation, Entertainment, Communication 6

Personal hotspot, see Owner's Manual for Navigation, Entertainment, Communication 6

Personal Mode, see MINI Modes 135

Personal profile, see MINI ID 67

Personal settings 66

Physical units, see Setting units of measurement 159

Plastic parts, care 396

Plug & Charge 338

PostCrash iBrake 213

Power failure 382

Power gauge 151

Power interruption 382

POWER, see Drive-ready state 47

Power windows 97

Pre-conditioning 291

PreCrash functions, see Active Protection 212

Preparing the battery, see Preparing the high-voltage battery 339

Preparing the high-voltage battery 339

Pressure monitor, tire, see Tire Pressure Monitor 359

Pressure, tires 347

Pressure warning, see Flat tire monitor 366

Pressure warning, see Tire Pressure Monitor 359

Prevention of rear-end collision, see Rear-end collision preparation 200

Protective function, glass sunroof, see Anti-trap mechanism 102

Protective function, windows, see Anti-trap mechanism 99

Q

Quick charging cable, see Mode 3 charging cable 334

R

Racing track 316

Radar sensors, see Vehicle sensors 40

Radiator fluid 376

Radio information, see Owner's Manual for Navigation, Entertainment, Communication 6

Radio, see Owner's Manual for Navigation, Entertainment and Communication 6

Radio stations, see Owner's Manual for Navigation, Entertainment, Communication 6

Rain sensor 171

Rain sensor mode 171

Range 153

Range prediction 154

READY indicator, see Standby and drive-ready state 152

Rear automatic climate control 283

- Rear-end collision preparation [200](#)
Rear lights, replacing, see [Lights and bulbs 381](#)
Rear luggage rack [326](#)
Rear-mounted luggage rack [326](#)
Rear seat backrests, folding down [308](#)
Rear seat backrest tilt [108](#)
Rear seats [108](#)
Rearview camera [254](#)
Rearview camera, see [Vehicle sensors 40](#)
Rear-view mirror, exterior [115](#)
Rear-view mirror, interior [117](#)
Rear window defroster [289](#)
Rear window wiper, operation [172](#)
Rear wiper [172](#)
Rechargeable battery, charging, see [Vehicle, charging 332](#)
Recirculated-air mode [287](#)
Recirculating air filter, see [Interior filter 291](#)
Recommended tire brands [353](#)
Recuperation, adaptive [327](#)
Recuperative braking, see [Energy recovery 17](#)
Reduced drive power [151](#)
Remaining range, see [Range 153](#)
Remote 3D View [261](#)
Remote control, see [Remote Control Parking 277](#)
Remote control, see [Vehicle key 74](#)
Remote parking [277](#)
Remote services, see [Owner's Manual for Navigation, Entertainment, Communication 6](#)
Renewal, wheels and tires [353](#)
Replacement, wheels and tires [353](#)
Replacing bulbs, see [Lights and bulbs 381](#)
Replacing light diodes, see [Lights and bulbs 381](#)
Replacing parts [380](#)
Replacing the battery, vehicle key [75](#)
Reporting safety malfunctions [15](#)
Reserve warning, see [Range 153](#)
Reservoir, washer fluid [376](#)
Resetting, vehicle data [67](#)
Reset, Tire Pressure Monitor [361](#)
Reset, vehicle settings [67](#)
Restricted Driving, see [MINI Digital Key 89](#)
Retreaded tires [354](#)
Reversing Assistant [279](#)
Reversing Assistant Professional [279](#)
Risk of collision when exiting [189](#)
Roadside parking lights [165](#)
Rolling to a stop with engine decoupled, see [Coasting 328](#)
Roof bars [316](#)
Roofliner [39](#)
Roof luggage rack, refer to [Roof bars 316](#)
Rope for tow-starting/towing [390](#)
Rough roads [315](#)
Route and Intersection Assistant, see [Adjusting speed to route 247](#)
Route, navigation, see [Owner's Manual for Navigation, Entertainment, Communication 6](#)
Rubber components, care [396](#)
- ## S
- Safe braking [314](#)
Safe Exit, see [Exit warning 189](#)
Safe Share function, see [MINI Digital Key 89](#)
Safety and warning, see [Collision warning systems 178](#)
Safety locks, doors, and windows [125](#)
Safety of the high-voltage system [19](#)
Safety package, see [Active Protection 212](#)
Safety switch, windows [99](#)
Safety systems, see [Airbags 174](#)
Safety systems, see [Collision warning systems 178](#)
Satellite radio, see [Owner's Manual for Navigation, Entertainment, Communication 6](#)
Saved stations, see [Owner's Manual for Navigation, Entertainment, Communication 6](#)
Sealant, see [Tire repair set 355](#)
Seamless mode change, see [Remote Control Parking 277](#)
Search for charging stations, see [Owner's Manual for Navigation, Entertainment, Communication 6](#)

- Seat belt reminder, see Seat belt warning 111
- Seat belts 109
- Seat belts, care 396
- Seat belt warning 111
- Seat calibration 107
- Seat heating 289
- Seating position for children 120
- Seat massage 107
- Seats and head restraints 104
- Seats, front 104
- Seats, rear 108
- Securing, cargo 305
- Securing vehicle to prevent rolling away, see Parking brake 137
- Selection list on the instrument cluster 152
- Selector lever position 128
- Selector lever position B, see Energy recovery B 128
- Selector lever position B, see Gear position B 129
- Selector lever positions, see Steptronic transmission 128
- Semi-automatic camera perspective 255
- Sensors, care 397
- Service and warranty 11
- Service life of high-voltage battery 345
- Service notifications 159
- Service notifications, see Condition Based Service 378
- Servotronic 220
- SET button, see Speed control systems 223
- Setting the time, see Time 158
- Setting units of measurement 159
- Shortcuts, Interaction Unit 52
- Side airbag 174
- Side Collision Warning 198
- Side protection, see Automatic camera perspective 255
- Side view 256
- Signaling, horn 36
- Signals when unlocking, see Confirmation signals 94
- SIM Reader, see Owner's Manual for Navigation, Entertainment, Communication 6
- Sitting safely 104
- Slipperiness, see Outside temperature 158
- Slippery road, see Outside temperature 158
- Smartphone, see Owner's Manual for Navigation, Entertainment and Communication 6
- Smartphone, using via voice control 58
- Snapshot camera, see Interior camera 296
- Snow chains 359
- Sockets, electrical devices 293
- Software version, see MINI Remote Software Upgrade 61
- SOS button, see Intelligent emergency call 386
- Sound of engine, see MINI Sound 282
- Sound settings, see Owner's Manual for Navigation, Entertainment, Communication 6
- Speed control systems 223
- Speed indicator, see Driving data 54
- Speed Limit Assist 245
- Speed Limit Assistant 245
- Speed limit device, speed limiter, see Speed control systems 223
- Speed limit, display, see Speed Limit Info 221
- Speed limiter, manual, see Speed control systems 223
- Speed Limit Info 221
- Speedometer, see Driving data 54
- Speed warning 221
- Sport Boost function 134
- Sport displays 157
- SPORT PLUS setting, see Setting for increased driving dynamics 218
- Stability control systems 216
- Standard charging cable 334
- Standard charging, see Vehicle, charging 332
- Standard equipment, see Vehicle equipment 8
- Standby state, see Operating state of vehicle 45
- Start/Stop button 127
- Start/Stop button, driving 127
- Starting the engine with the Key Card 88

- Stations, see Owner's Manual for Navigation, Entertainment, Communication 6
- Status control display, tires 361
- Status information, MINI Interaction Unit 51
- Status of Owner's Manual 9
- Status, vehicle 156
- Steering column adjustment 117
- Steering support, see Servotronic 220
- Steering wheel, adjusting 117
- Steering wheel, buttons 36
- Steering wheel heating 289
- Storage, charging cable 335
- Storage compartments 300
- Storage, tires 355
- Store Mirror position, see Memory function 118
- Store seat position, see Memory function 118
- Store steering wheel position, see Memory function 118
- Storing the vehicle 379
- Stowage, cargo 305
- Stowing the charging cable, see Storage 335
- Straps for cargo, see Lashing eyes in the cargo area 305
- Summer tires, tread 352
- Sun visor 293
- Supplementary Owner's Handbooks 7
- Supplementary Owner's Manuals 7
- Swinging of trailer, see Trailer stabilization control 325
- Switch cluster 38
- Switches, see Dashboard 36
- SYNC program, automatic climate control 288
- System language, setting, see Language, setting 57
- T**
- Tachometer, see Driving data 54
- Tailgate, opening and closing with no-touch activation 87
- Tail lights, replacing, see Lights and bulbs 381
- Taking the vehicle out of service 379
- Technical changes, see For Your Own Safety 9
- Technical data 398
- Telephone, see Owner's Manual for Navigation, Entertainment and Communication 6
- Telephone, selection list in the instrument cluster 152
- Teleservices, see Owner's Manual for Navigation, Entertainment, Communication 6
- Temperature, automatic climate control 285
- Temperature display, see outside temperature 158
- Theft alarm system, see Alarm system 95
- Tilt alarm sensor 96
- Tilt, backrest 106
- Tilting down, front passenger's side exterior mirror, see Automatic Curb Monitor 116
- Time 158
- Timeless Mode, see MINI Modes 135
- Time of day, see Time 158
- Time setting, automatic 158
- Time zone 158
- Tire brands, recommendation 353
- Tire change 353
- Tire damage 352
- Tire identification marks 350
- Tire inflation pressure 347
- Tire marking 350
- Tire pressure 347
- Tire Pressure Monitor 359
- Tire pressure monitoring, see Flat tire monitor 366
- Tire Pressure Monitor, reset 361
- Tire pressure, tires 347
- Tire pressure warning, see Flat tire monitor 366
- Tire repair set 355
- Tires and wheels 347
- Tire sealant, see Tire repair set 355
- Tire settings 360
- Tire tread 352
- Tools 380
- Torque display, see Sport displays 157
- Tow bar 390
- Towing 388

Towing eye [390](#)
 Tow rope [390](#)
 Traction control system, see Dynamic Stability Control [216](#)
 Traffic bulletins, see Owner's Manual for Navigation, Entertainment, Communication [6](#)
 Traffic Jam Assistant, Assisted Driving Mode Plus, see Speed control systems [223](#)
 Traffic Light And Sign Warning [201](#)
 Trailer angle, Trailer Assistant [322](#)
 Trailer Assistant [322](#)
 Trailer hitch, ball head, removable [319](#)
 Trailer hitch, care [319](#)
 Trailer hitch, mount for [319](#)
 Trailer hitch view [257](#)
 Trailer stabilization control [325](#)
 Trailer towing [318](#)
 Trailer towing, activation [321](#)
 Trail Mode, see MINI Modes [135](#)
 Transporting children safely [120](#)
 Tread, tires [352](#)
 Trunk, see Cargo area [304](#)
 Turn indicators, see Turn signals [160](#)
 Turning circle lines, additional camera view displays [252](#)
 Turning display, see No Turn on Red function [204](#)
 Turn signal, indicator light [149](#)
 Turn signal, replacing bulbs, see Lights and bulbs [381](#)
 Turn signals [160](#)
 Turn Warning, see Forward Collision Mitigation [180](#)

U

Ultrasonic sensors, see Vehicle sensors [40](#)
 Unintended alarm, see Unintentional alarm, avoiding [96](#)
 Unintentional alarm, avoiding [96](#)
 Units, see Setting units of measurement [159](#)
 Unlocking, see Opening and Closing [74](#)
 Unlocking, settings [93](#)

Unlocking the transmission lock, electronic [131](#)
 Unpaved roads, see Driving on poor roads [315](#)
 Updates made after the editorial deadline [9](#)
 Updating software, see MINI Remote Software Upgrade [61](#)
 Upgrade, see MINI Remote Software Upgrade [61](#)
 Upgrading software, see MINI Remote Software Upgrade [61](#)
 Upholstery material care [395](#)
 Upper retaining strap, top tether [124](#)
 USB port, position in vehicle [294](#)
 Used battery, disposing of [383](#)
 Use, intended [9](#)

V

Vanity mirror [293](#)
 Vehicle battery [381](#)
 Vehicle breakdown, see Breakdown assistance [384](#)
 Vehicle care [394](#)
 Vehicle care products [394](#)
 Vehicle, charging [332](#)
 Vehicle data, resetting [67](#)
 Vehicle equipment [8](#)
 Vehicle identification number [14](#)
 Vehicle issues [384](#)
 Vehicle key [74](#)
 Vehicle key, additional [75](#)
 Vehicle key, loss [75](#)
 Vehicle paint, care [394](#)
 Vehicle paintwork [394](#)
 Vehicle rolling away, see Parking brake [137](#)
 Vehicle sensors [40](#)
 Vehicle shutdown, high-voltage battery [345](#)
 Vehicle status [156](#)
 Vehicle storage [379](#)
 Ventilation [290](#)
 Venting, see Pre-conditioning [291](#)
 Venting, see Ventilation [290](#)
 Video recording, see Drive Recorder [209](#)
 VIN, see Vehicle identification number [14](#)
 Vivid Mode, see MINI Modes [135](#)

Voice activation system [55](#)
Voice control [55](#)
Voice control, see MINI Intelligent Personal Assistant [55](#)
Voice recognition [55](#)
Volume, see Owner's Manual for Navigation, Entertainment, Communication [6](#)

W

Wake word [56](#)
Warning for crossing traffic [206](#)
Warning function for incorrect driving direction, see Wrong Way Warning [203](#)
Warning function for oncoming traffic, see Forward Collision Mitigation [180](#)
Warning function, rear-end collision [200](#)
Warning light in exterior mirror, see Active Blind Spot Detection [195](#)
Warning light in exterior mirror, see Cross Traffic Warning [206](#)
Warning lights [145](#)
Warning messages, see Check Control [144](#)
Warning systems for collision hazards [178](#)
Warning triangle [384](#)
Warning when exiting [189](#)
Warning when opening doors, see Exit Warning [189](#)
Warranty [9](#)
Warranty Booklet, see Warranty [9](#)
Washer fluid [376](#)
Washer nozzles, windshield [172](#)
Washing the vehicle [392](#)
Washing, vehicle [392](#)
Water, high-voltage system [19](#)
Water on road [313](#)
Water, see Condensation water under the parked vehicle [315](#)
Website, see Internet [7](#)
Welcome lights [165](#)
Welcome screen, driver profiles [67](#)
Wheel change [368](#)
Wheels and tires [347](#)
Wheels and tires, exchange [353](#)
Widgets, MINI Interaction Unit [51](#)

Wi-Fi connection, see Owner's Manual for Navigation, Entertainment, Communication [6](#)
Wind deflector, defrosting [288](#)
Wind deflector, removing condensation [288](#)
Window, defrosting [288](#)
Windows, powered [97](#)
Windshield cleaning system, see Wiper system [170](#)
Windshield, defrosting [288](#)
Windshield, removing condensation [288](#)
Windshield washer fluid, see Washer fluid [376](#)
Windshield washer nozzles [172](#)
Windshield wipers, see Wiper system [170](#)
Winter storage, see Long-term vehicle storage [379](#)
Winter tires [354](#)
Winter tires, tread [352](#)
Wiper blades, replacing [380](#)
Wiper fluid, see Washer fluid [376](#)
Wiper, fold-away position [172](#)
Wipers, see Wiper system [170](#)
Wiper system [170](#)
Wireless charging, smartphone, see Wireless charging tray [295](#)
Wireless charging tray for smartphones [295](#)
Wood parts, care [396](#)
Wordmatch principle, see Entry comparison [52](#)
Wrong Way Warning [203](#)

Y

Yield warning [201](#)

01405B45A27 ue



California Proposition 65 Warning

For vehicles sold in California:

California Proposition 65 Warning

 **WARNING**

Operating, servicing and maintaining a passenger vehicle or off-highway motor vehicle can expose you to chemicals including engine exhaust, carbon monoxide, phthalates, and lead, which are known to the State of California to cause cancer and birth defects or other reproductive harm. To minimize exposure, avoid breathing exhaust, do not idle the engine except as necessary, service your vehicle in a well-ventilated area and wear gloves or wash your hands frequently when servicing your vehicle. For more information go to www.P65Warnings.ca.gov/passenger-vehicle.

MINI MOTORER'S GUIDE APP.

YOUR DIGITAL VEHICLE INFORMATION.

The MINI Motorer's Guide app explains the equipment of your vehicle and offers further scopes and functions:

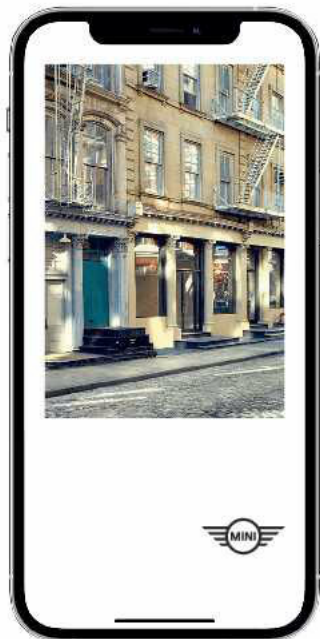

All information surrounding navigation, entertainment and communication

Photorealistic animations for various vehicle functions

Keyword search

360° view: Explore your vehicle interactively inside and out

Smart Scan for Apple iPhone: Icon and optical character recognition on the buttons in the vehicle

Available in more than 30 languages



Can be used offline after download



01405B45A27 ue